

Fiyat Listesi / Ağustos 2020

Let's connect.

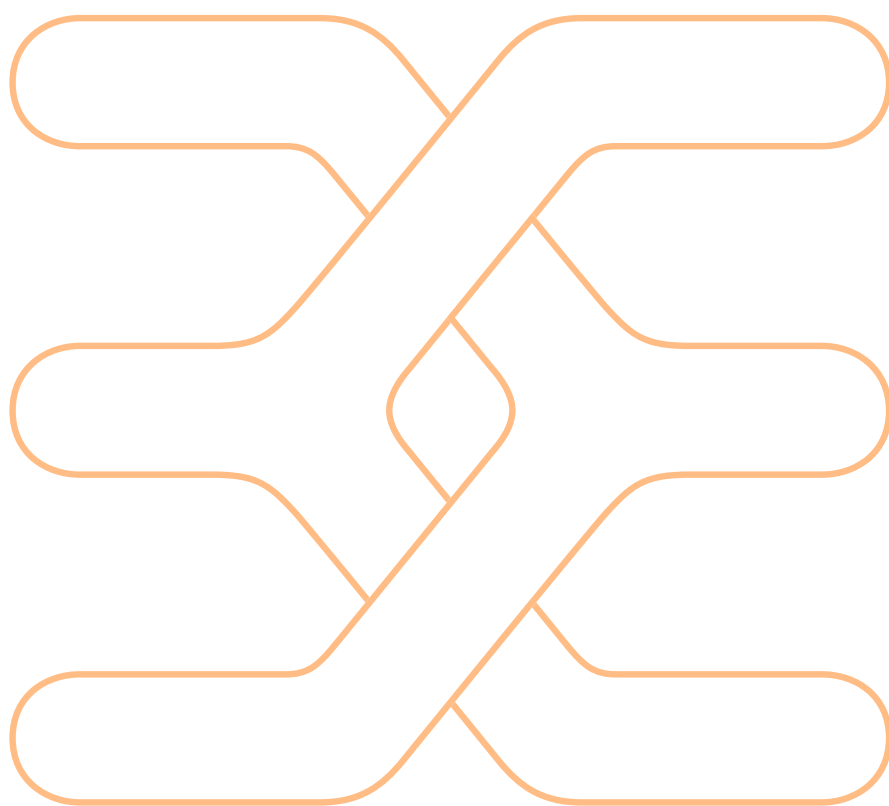



Weidmüller Fiyat Listesi / Ağustos 2020

İçindekiler ve Önsöz	A + B	İçindekiler
W Serisi Ray Klemensleri ve Aksesuarları - Vida Bağlantı Teknolojisi	1 - 9	Klemens ve Aksesuarları
Bara-Ekranlama -Cihaz Sıra Ve Panel Klemensleri	10	
WMF Serisi Marshalling Ray Klemensleri - Vida Bağlantı Teknolojisi	11 - 12	
Z Serisi Ray Klemensleri - Yaylı Bağlantı Teknolojisi	13 - 17	
Klippon Connect PUSH IN Klemens Serisi	18 - 23	
Soketli Klemens Çözümleri	24 - 27	
Güç ve Sinyal Dağıtım Çözümleri	28 - 32	
Markalama	33 - 47	Markalama PCB Fiş Soket EI Aletleri
PCB - Baskılı Devre Klemensleri	48 - 50	
Rockstar Sanayi Tipi Fiş- Soket	51 - 56	
EI Aletleri	57 - 64	
Kutular	65 - 68	Kutu Yüksük Papuç SKP Kanal Ray Spiral Kablo Bağı
Yüksükler ve Papuçlar	69 - 72	
Kablo Kanalları - Ray ve Aksesuarları - Spiral Hortum - Rakorlar ve LED Aydınlatma	73 - 74	
Frontcom® Vario & LED Aydınlatma	75 - 76	
Kablo Bağları	77 - 78	
u-mation Otomasyon Ürünleri	79 - 86	u-mation SAI Endüstriyel Ethernet
SAI - Sensör Aktuatör Arayüzleri	87 - 91	
Endüstriyel Ethernet	92 - 98	
Röleler ve Optokuplörler	99 - 111	Röleler ve Optokuplörler Analog Sinyal Dönüştürücü
Analog Sinyal Dönüştürücüler	112 - 118	
Enerji Analizörleri	119 - 120	Enerji Analizörleri Güç Kaynağı Panelür Uygulamaya Özel Çözümler
Güç Kaynakları	121 - 126	
Aşırı Gerilim Koruma Modülleri	127 - 130	
Uygulamaya Özel Çözümler	131 - 133	
Sıralı Liste	134 - 148	Ürün Sıralı Listesi
Yetkili Bayilerimiz ve Otomasyon Partnerlerimiz	149	

Şirket Profili

Weidmüller, elektriksel bağlantılar, sinyal, veri, güç dağıtım ve işlenmesi konularında endüstriyel ortamlarda sunduğu çözümler ile sektöründe lider konuma sahip global bir firmadır.

Firmamız, genel merkezinin de bulunduğu Almanya / Detmold yerleşkesi ve üç kıtaya yayılan diğer fabrikalarında araştırma, geliştirme ve üretim faaliyetlerini yürütmekte olup, ürettiği elektronik ve elektriksel bağlantı ürünlerinin tüm dünya geneline satışını gerçekleştirmektedir. Bunun yanı sıra Weidmüller uzmanlardan oluşturduğu teknik ağ yapısı ile uygulamaya özel çözümler üreten mühendislik hizmetlerini de müşterilerine sunmaktadır.

Komple ürün ve hizmet portföyüyle toplam çözüm tedarikçisi olmayı amaçlayan Weidmüller, zengin ürün ve hizmetleriyle müşterilerin rekabetçi avantajlar kazanmalarını ve faaliyetlerine değer katmalarını sağlar.

Weidmüller, dünya genelinde 80'den fazla ülkede faaliyet gösteren üretim tesisleri, satış ofisleri ve temsilcilikleri ile müşterilerine hizmet vermektedir.

W Serisi Ray Klemensleri - Vida Bağlantı Teknolojisi

Weidmüller'in W serisi olan vida bağlantılı ray klemensleri uzun bir zamandan beri standartları belirlemektedir. Detaylarına kadar mükemmelleştirilmiş bir çok üstün özellikleri bu seriye zirvede bir pozisyonu garanti eder.

W serisi 0.06'dan 300 mm²'ye iletkenler için tüm genel elektrik uygulamalarına uygun bağlantı çözümü sunmaktadır.

W serisinin diğer bir avantajı da vidalı WQV serisi üst köprülerin yanında ZQV serisi vidasız üst köprülerde kullanılabilmesidir.

- ZQV serisi vidasız köprü kullanılması ile diğer vida bağlantılı klemensler ile karşılaştırıldığında önemli ölçüde zamandan kazanç sağlar.
- ZQV serisi vidasız köprüler 2.5 ve 4 mm² klemensler için 10 kutup'a kadar standarttır.
- 50 Kutuplu olarak tercih edilerek istenilen kutup sayısında kesilerek kullanılabilir.

Weidmüller'in patentli tasarımı sayesinde W serisi klemenslere aynı çapta iki iletken kolaylıkla bağlanabilir.

W Serisi Şu Klemens Tiplerini Kapsar ;

- **WDU** - Geçiş Klemensleri
- **WPE** - Topraklama Klemensleri
- **WNT** - Nötr Klemensleri
- **WDL** - Üç İletkenli Dağıtım Klemensleri
- **WTR** - Ölçme Ayırma Klemensleri
- **WSI** - Sigortalı Klemensler
- **WDK** - Çok Katlı Klemensler

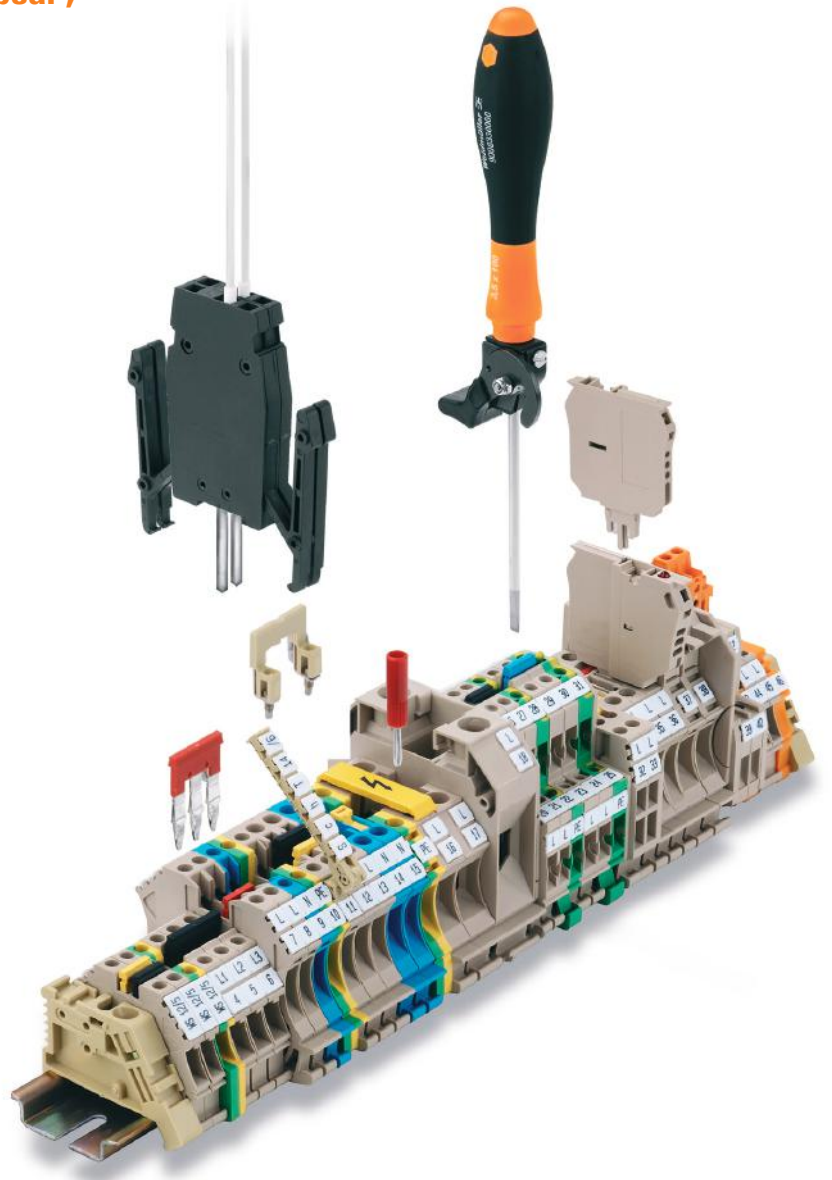

W Serisi Ray Klemensleri - Vida Bağlantı Teknolojisi



WDU 2.5



WDU 2.5 BL

Tip	V / A	Kesit - mm ² (Yüksüksüz)	Sipariş No	Fiyat/Birim	Ambalaj
Geçiş Klemensleri					
WDU 2.5	800 / 24	0.05 - 4 mm ²	1020000000	4,80 TL	100
WDU 2.5 BL	800 / 24	0.05 - 4 mm ²	1020080000	4,80 TL	100
WDU 4	800 / 32	0.5 - 6 mm ²	1020100000	6,00 TL	100
WDU 4 BL	800 / 32	0.5 - 6 mm ²	1020180000	6,00 TL	100
WDU 6	800 / 41	0.5 - 10 mm ²	1020200000	10,15 TL	100
WDU 6 BL	800 / 41	0.5 - 10 mm ²	1020280000	10,15 TL	100
WDU 10	1000 / 57	1.5 - 16 mm ²	1020300000	13,80 TL	50
WDU 10 BL	1000 / 57	1.5 - 16 mm ²	1020380000	13,80 TL	50
WDU 16	1000 / 76	1.5 - 25 mm ²	1020400000	18,60 TL	50
WDU 16 BL	1000 / 76	1.5 - 25 mm ²	1020480000	18,60 TL	50
WDU 35	1000 / 125	2.5 - 50 mm ²	1020500000	41,80 TL	40
WDU 35 BL	1000 / 125	2.5 - 50 mm ²	1020580000	41,80 TL	40
WDU 70/95	1000 / 232	16 - 120 mm ²	1024600000	334,10 TL	10
WDU 70/95 BL	1000 / 232	16 - 120 mm ²	1024680000	334,10 TL	10
WDU 120/150	1000 / 269	35 - 150 mm ²	1024500000	470,20 TL	10
WDU 120/150 BL	1000 / 269	35 - 150 mm ²	1024580000	470,20 TL	10
WDU 240	1000 / 415	70 - 240 mm ²	1802780000	509,00 TL	2
WDU 240 BL	1000 / 415	70 - 240 mm ²	1822210000	509,00 TL	2

Renk Tipleri



WDU 2.5	102000	102008	102006	103771	102002	102009	102004	102001	103770	103680
WDU 4	102010	102018	103676	103781	102012	102016	102014	102011	103782	103670
WDU 6	102020	102028	102026	-	104022	102029	102024	102021	-	-
WDU 10	102030	102038	102036	-	-	-	102034	102031	-	-
WDU 16	102040	102048	-	-	-	-	-	-	-	-
WDU 35	102050	102058	-	-	-	-	-	-	-	-



WDU 2.5/1.5/ZR

Tip	V / A	Kesit - mm ² (Yüksüksüz)	Sipariş No	Fiyat/Birim	Ambalaj
İkili Geçiş Klemensleri					
WDU 2.5/1.5/ZR	800 / 24	0.5 - 4 mm ² / 2 x 0.5 - 1.5 mm ²	1024700000	29,00 TL	100
WDU 1.5/ZZ	800 / 17.5	0.5 - 2.5 mm ²	1031400000	29,00 TL	100
WDU 4/ZR	800 / 32	0.5 - 6 mm ²	1905140000	30,85 TL	50
WDU 4/ZZ	800 / 32	1.5 - 6 mm ²	1905060000	34,15 TL	50
WDU 10/ZR	800 / 57	1.5 - 16 mm ²	1042400000	46,25 TL	50

İki Katlı Klemensler (Her İki Kat Köprülenebilir)

WDK 2.5	400 / 24	0.5 - 4 mm ²	1021500000	16,60 TL	100
WDK 2.5 BL	400 / 24	0.5 - 4 mm ²	1021580000	18,95 TL	100
WDK 2.5V	400 / 24	0.5 - 4 mm ²	1022300000	62,20 TL	50
WDK 10	800 / 57	1.5 - 16 mm ²	1186740000	66,85 TL	50
WDK 10 BL	800 / 57	1.5 - 16 mm ²	1186750000	66,85 TL	50

Üç Katlı Klemensler (Her Üç Kat Köprülenebilir)

DLD 2.5 DB	250 / 24	0.5 - 4 mm ²	1784180000	42,35 TL	50
DLD 2.5/PE DB	250 / 24	0.5 - 4 mm ²	1783790000	49,00 TL	50
WDL 2.5/S/N/L/PE	400 / 24	0.5 - 4 mm ²	1030700000	42,35 TL	50
WDL 2.5/S/L/L/PE	400 / 24	0.5 - 4 mm ²	1031100000	41,20 TL	50
WDL 2.5/N/L/PE	400 / 24	0.5 - 4 mm ²	1029900000	52,70 TL	50
WDL 2.5/L/L/PE	400 / 24	0.5 - 4 mm ²	1030200000	50,75 TL	50



WDK 2.5



DLD 2.5 DB



DLI 2.5 DB

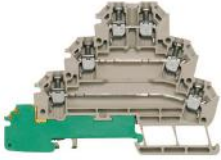

MAK 2.5 DB



WPE 2.5



WTR 2.5



WDK 2.5/TR-DU



WDK 2.5/TR-DU-PE



WTL 6/1



WTL 6/2

Tip	V / A	Kesit - mm ² (Yüksüzsüz)	Sipariş No	Fiyat/Birim	Ambalaj
Sensör - Aktüatörler için Köprülenebilir Beslemeli, Üç Katlı Klemensler					
DLI 2.5 DB	250 / 24	0.5 - 4 mm ²	1783820000	46,90 TL	100
DLI 2.5/LD-RT/PNP +- DB	30 / 24	0.5 - 4 mm ²	1783980000	88,60 TL	50
DLI 2.5/LD-RT/NPN +- DB	30 / 24	0.5 - 4 mm ²	1783950000	88,60 TL	50
DLA 2.5 DB	250 / 17.5	0.5 - 4 mm ²	1783560000	59,80 TL	100
DLA 2.5/LD-RT DB	30 / 17.5	0.5 - 4 mm ²	1783600000	82,85 TL	50
DLA 2.5/D DB	250 / 17,5	0.5 - 4 mm ²	1783590000	57,10 TL	100
Dört Katlı Klemens (3 Faz + Toprak, Motor Bağlantıları İçin)					
MAK 2.5 DB	500 / 24	0.5 - 4 mm ²	7917030000	77,75 TL	50
VLI 1.5 DB	250 / 17.5	0.5 - 2.5 mm ²	1784120000	38,60 TL	50
VLI 1.5/PE DB	250 / 17,5	0.5 - 2.5 mm ²	1784130000	56,00 TL	50
Topraklama Klemensleri					
WPE 2.5	800	0.05 - 4 mm ²	1010000000	20,20 TL	100
WPE 4	800	0.5 - 6 mm ²	1010100000	26,65 TL	100
WPE 6	1000	0.5 - 10 mm ²	1010200000	35,30 TL	50
WPE 10	1000	1.5 - 16 mm ²	1010300000	36,55 TL	50
WPE 16	1000	1.5 - 25 mm ²	1010400000	53,35 TL	50
WPE 35	800	2.5 - 50 mm ²	1010500000	84,80 TL	25
WPE 70/95	1000	16 - 95 mm ²	1037300000	482,95 TL	10
WPE 120/150	1000	95 - 150 mm ²	1019700000	691,00 TL	10
Nötr (N) - Ayrırma Klemensleri (10x3 mm'lik Baralar İçin)					
WNT 2.5 10X3	400 / 24	0.13 - 4 mm ²	1010680000	34,15 TL	100
WNT 4 10X3	400 / 32	0.5 - 6 mm ²	1010780000	34,75 TL	100
WNT 6 10X3	400 / 41	0.5 - 10 mm ²	1010880000	39,20 TL	50
WNT 10 10X3	400 / 57	1.5 - 16 mm ²	1010980000	46,25 TL	50
WNT 16N 10X3	400 / 76	1.5 - 25 mm ²	1019000000	56,50 TL	50
Ölçme Ayrırma Klemensleri					
WTR 2.5	500 / 24	0.5 - 2.5 mm ² / Test ayırma	1855610000	36,00 TL	100
WTR 2.5 STB2.3	500 / 24	0.5 - 2.5 mm ² / Test ayırma / Test Soket	1855620000	41,00 TL	100
WTR 2.5/ZZ	400 / 16	0.5 - 2.5 mm ² / Test ayırma / iki giriş, iki çıkış	1039900000	53,35 TL	100
WTR 4	400 / 32	0.5 - 4 mm ² / Test ayırma	7910180000	50,75 TL	50
WTR 4 STB	400 / 32	0.5 - 4 mm ² / Test ayırma / Test Soket	7910210000	56,50 TL	50
WTR 4/ZZ	500 / 27	0.5 - 4 mm ² / Test ayırma / iki giriş, iki çıkış	1905090000	61,60 TL	50
WTR 4/ZZ STB	500 / 27	0.5-4 mm ² / Test ayırma / Test Soket / İki giriş, iki çıkış	1905100000	68,70 TL	50
WDK 2.5/TR-DU	690 / 24	0.5 - 2.5 mm ² / Test ayırma / İki Katlı	1247290000	75,10 TL	50
WDK 2.5/TR-DU STB	690 / 24	0.5 - 2.5 mm ² / Test ayırma / Test Soket / İki Katlı	1247310000	84,80 TL	50
WDK 2.5/TR-DU-PE	690 / 24	0.5 - 2.5 mm ² / Test ayırma / Üç Katlı	1247420000	120,80 TL	50
WDK 2.5/TR-DU-PE STB	690 / 24	0.5 - 2.5 mm ² / Test ayırma / Test Soket / Üç Katlı	1247430000	133,50 TL	50
WTL 4	500 / 32	0.5 - 4 mm ² / Sürgü ayırma	1754960000	48,80 TL	50
WTL 4/STB	500 / 32	0.5 - 4 mm ² / Sürgü ayırma / Test Soket	1754970000	52,70 TL	50
WTL 6/1 EN	630 / 41	0.5 - 6 mm ² / Sürgü ayırma	1934810000	48,00 TL	50
WTL 6/1 EN STB	630 / 41	0.5 - 6 mm ² / Sürgü ayırma / Test Soket	1934820000	59,00 TL	50
WTL 6/1	630 / 41	0.5 - 6 mm ² / Sürgü ayırma	1016700000	45,60 TL	50
WTL 6/1/STB	630 / 41	0.5 - 6 mm ² / Sürgü ayırma / Test Soket	1016900000	46,25 TL	50
WTD 6/1 EN	630 / 41	0.5 - 6 mm ² / Direk Besleme	1934830000	49,90 TL	50
WTL 6/2	500 / 41	0.5 - 6 mm ² / Sürgü ayırma / Test Soket	1017700000	51,00 TL	50
WTL 6/3	500 / 41	0.5 - 6 mm ² / Sürgü ayırma	1018800000	62,00 TL	50
WTL 6/3/STB	500 / 41	0.5 - 6 mm ² / Sürgü ayırma / Test Soket	1018600000	99,60 TL	50

W Serisi Ray Klemensleri - Vida Bağlantı Teknolojisi



WSI 4



KDKS 1/35 DB



WSI 25/1 10x38



WTR 2.5/SI



WDK 2.5 1D A.2



WDU 1.5/BLZ 5.08



WDU 2.5N

Tip	V / A	Kesit - mm ² (Yüksüksüz)	Sipariş No	Fiyat/Birim	Ambalaj
Sigortalı Klemensler					
WSI 4/2	500 / 6.3	0.5 - 4 mm ² / G25 Sigorta	1880430000	28,30 TL	25
WSI 4/2/LD 10-36V AC/DC	500 / 6.3	0.5 - 4 mm ² / G25 Sigorta / LED	1880410000	65,50 TL	25
WSI 4/2/LD 30-70V AC/DC	500 / 6.3	0.5 - 4 mm ² / G25 Sigorta / LED	1880440000	65,50 TL	25
WSI 4/2/LD 60-150V AC/DC	500 / 6.3	0.5 - 4 mm ² / G25 Sigorta / LED	1880420000	65,50 TL	25
WSI 4/2/LD 140-250V AC/DC	500 / 6.3	0.5 - 4 mm ² / G25 Sigorta / LED	1880390000	65,50 TL	25
WSI 4	500 / 6.3	0.5 - 4 mm ² / G20 Sigorta	1886580000	55,20 TL	50
WSI 4/LD 10-36V AC/DC	500 / 6.3	0.5 - 4 mm ² / G20 Sigorta / LED	1886590000	84,80 TL	50
WSI 4/LD 30-70V AC/DC	500 / 6.3	0.5 - 4 mm ² / G20 Sigorta / LED	1886560000	84,80 TL	50
WSI 4/LD 60-150V AC/DC	500 / 6.3	0.5 - 4 mm ² / G20 Sigorta / LED	1886570000	84,80 TL	50
WSI 4/LD 140-250V AC/DC	500 / 6.3	0.5 - 4 mm ² / G20 Sigorta / LED	1886550000	84,80 TL	50
KDKS 1/35 DB	500 / 6.3	0.5 - 4 mm ² / G20 Sigorta / İki katlı	9532440000	75,10 TL	50
WSI 6	500 / 6.3	0.5 - 6 mm ² / G20 Sigorta	1011000000	33,25 TL	50
WSI 6/LD 10-36V DC/AC	500 / 6.3	0.5 - 4 mm ² / G20 Sigorta / LED	1011300000	81,65 TL	10
WSI 6/LD 30-70V DC/AC	500 / 6.3	0.5 - 4 mm ² / G20 Sigorta / LED	1012200000	81,65 TL	10
WSI 6/LD 60-150V DC/AC	500 / 6.3	0.5 - 4 mm ² / G20 Sigorta / LED	1012300000	81,65 TL	10
WSI 6/LD 250AC	500 / 6.3	0.5 - 4 mm ² / G20 Sigorta / LED	1012400000	81,65 TL	10
WSI 25/1 10x38	690 / 32	0.5 - 25mm ² / Buşon Sigorta / 1 Kutup	1966020000	82,85 TL	12
WSI 25/2 10x38	690 / 32	0.5 - 25mm ² / Buşon Sigorta / 2 Kutup	1966090000	152,90 TL	6
WSI 25/3 10x38	690 / 32	0.5 - 25mm ² / Buşon Sigorta / 3 Kutup	1966080000	249,85 TL	4
WSI 25/1 10x38/LED	690 / 32	0.5 - 25mm ² / Buşon Sigorta / 1 Kutup / LED	1966060000	142,60 TL	12
WSI 25/1 10x38 1KV	1000 / 32	0.5 - 25mm ² / Buşon Sigorta / 1 Kutup	1137790000	180,50 TL	12
WSI 25/1 10x38/LED 1KV	1000 / 32	0.5 - 25mm ² / Buşon Sigorta / 1 Kutup / LED	1137780000	334,70 TL	12
WTR 2.5/SI	400 / 6.3	0.5 - 2.5 mm ² / G20 Sigorta	1763940000	70,00 TL	25
WTR 2.5/SI LD 36V	400 / 6.3	0.5 - 2.5 mm ² / G20 Sigorta / LED	1763950000	125,30 TL	25
WTR 4 SI	400 / 6.3	0.5 - 4 mm ² / G20 Sigorta	7910240000	80,40 TL	25
WTR 4/SI LD 36V	400 / 6.3	0.5 - 4 mm ² / G20 Sigorta / LED	7914370000	140,00 TL	25
WTR 4/SI LD 70V	400 / 6.3	0.5 - 4 mm ² / G20 Sigorta / LED	7914380000	140,00 TL	25
WTR 4/SI LD 150V	400 / 6.3	0.5 - 4 mm ² / G20 Sigorta / LED	7914390000	140,00 TL	25
WTR 4/SI LD 250V	400 / 6.3	0.5 - 4 mm ² / G20 Sigorta / LED	7914400000	140,00 TL	25
BEST/D	Max 250	WTR 2.5/ 1N4007 diyotlu fiş	1878560000	70,00 TL	50
Sigortalı Klemensler					
G 20/0.25A/F	0.25	Sigorta	0430500000	12,12 TL	10
G 20/0.50A/F	0.5	Sigorta	0430600000	14,00 TL	10
G 20/1.00A/F	1	Sigorta	0430700000	12,12 TL	10
G 20/2.00A/F	2	Sigorta	0430900000	12,12 TL	10
Diyotlu Klemensler					
WDK 2.5 1D A.2	400 / 10	0.05 - 4 mm ²	1023300000	78,35 TL	25
WDK 2.5 1D A.1	400 / 10	0.05 - 4 mm ²	1023400000	78,35 TL	25
WDK 2.5 2D	400 / 10	0.05 - 4 mm ²	1023500000	78,35 TL	25
WDK 2.5 2D 2.A	400 / 10	0.05 - 4 mm ²	1022600000	78,35 TL	25
WDK 2.5 LD RT 24VDC +- .24 / 10	.24 / 10	0.05 - 4 mm ²	1023600000	109,85 TL	25
Soket Bağlantılı Klemensler					
WDU 1.5/BLZ 5.08	250 / 16	0.5 - 4 mm ² /2xBLZ Soket	1577340000	26,30 TL	100
WDK 2.5/BLZ/5.08/ZA	250 / 16	0.5 - 4 mm ² /2xBLZ Soket	1034400000	34,15 TL	50
WT4 4AN/2	800 / 32	0.5 - 6 mm ² /2xZP Soket	1107680000	37,40 TL	50
Kompakt (Küçük) Tip Klemensler / Geçiş Klemensleri					
WDU 2.5N	500 / 24	0.05 - 4 mm ²	1023700000	6,00 TL	100
WDU 2.5N BL	500 / 24	0.05 - 4 mm ²	1023780000	6,00 TL	100
WDU 4N	500 / 32	0.5 - 6 mm ²	1042600000	12,90 TL	100

Serinin devamı sayfa 5



WDK 2.5N



WPE 2.5N



WPE 50N



WDU 1.5/R3.5



WDK 1.5/R3.5



WFF 35

Tip	V / A	Kesit - mm ² (Yüksüksüz)	Sipariş No	Fiyat/Birim	Ambalaj
WDU 4N BL	500 / 32	0.5 - 6 mm ²	1042680000	12,90 TL	100
WDU 16N	690 / 76	1.5 - 25 mm ²	1036100000	31,45 TL	50
WDU 16N BL	690 / 76	1.5 - 25 mm ²	1036180000	31,45 TL	50
WDU 35N	500 / 125	2.5 - 50 mm ²	1040400000	66,85 TL	20
WDU 35N BL	500 / 125	2.5 - 50 mm ²	1040480000	66,85 TL	20
WDU 50N	1000 / 150	16 - 70 mm ²	1820840000	168,25 TL	10
WDU 50N BL	1000 / 150	16 - 70 mm ²	1820850000	168,25 TL	10
WDU 70N/35	1000 / 192	35 - 95 mm ²	9512190000	227,40 TL	10
WDU 70N/35 BL	1000 / 192	35 - 95 mm ²	9512420000	227,40 TL	10
WDU 95N/120N	1000 / 269	16.0 - 150 mm ²	1820550000	293,45 TL	5
WDU 95N/120N BL	1000 / 269	16.0 - 150 mm ²	1820560000	293,45 TL	5

Kompakt (Küçük) İki Katlı Klemensler (Her İki Kat Köprülenebilir)

WDK 2.5N	800 / 24	0.05 - 4 mm ²	1041600000	26,00 TL	100
WDK 2.5N BL	800 / 24	0.05 - 4 mm ²	1041680000	26,00 TL	100
WDK 2.5N V	800 / 24	0.5 - 4 mm ² - İki kat köprülü	1041610000	74,45 TL	100
WDK 2.5N DU-PE	800 / 24	0.5 - 4 mm ² - Alt kat topraklama	1041650000	65,50 TL	100
WDK 4N	800 / 32	0.5 - 6 mm ²	1041900000	27,65 TL	100
WDK 4N BL	800 / 32	0.5 - 6 mm ²	1041980000	27,65 TL	100
WDK 4N V	800 / 32	0.5 - 6 mm ² - İki kat köprülü	1041910000	75,10 TL	100
WDK 4N DU-PE	800 / 32	0.5 - 6 mm ² - Alt kat topraklama	1041950000	64,85 TL	100

Kompakt (Küçük) Topraklama Klemensleri

WPE 2.5N	500	0.05 - 4 mm ²	1016200000	46,90 TL	100
WPE 4N	500	0.13 - 6 mm ²	1042700000	48,25 TL	100
WPE 16N	400	1.50 - 25 mm ²	1019100000	86,10 TL	50
WPE 35N	400	2.50 - 50 mm ²	1717740000	117,60 TL	20
WPE 50N	1000	10.0 - 70 mm ²	1846040000	320,50 TL	10
WPE 70N/35	1000	10.0 - 95 mm ²	9512200000	430,30 TL	10
WPE 95N/120N	1000	16.0 - 150 mm ²	1846030000	485,00 TL	5

Tip	V / A	Kesit (Yüksüksüz)	Sipariş No	Fiyat/Birim	Ambalaj
-----	-------	-------------------	------------	-------------	---------

W Serisi Mini Klemens

WDU 1.5/R3.5	400 / 17.5	0.5 - 1.5 mm ²	1753280000	22,40 TL	100
WDU 1.5/R3.5 BL	400 / 17.5	0.5 - 1.5 mm ²	1754170000	22,40 TL	100

W Serisi Mini İki Katlı Klemens

WDK 1.5/R3.5	400 / 16	0.5 - 1.5 mm ²	1753290000	51,35 TL	100
--------------	----------	---------------------------	------------	----------	-----

W Serisi Mini Topraklama Klemens

WPE 1.5/R3.5	400	0.5 - 1.5 mm ²	1798460000	55,20 TL	50
--------------	-----	---------------------------	------------	----------	----

Tip	V / A	Kesit - mm ² (Yüksüksüz)	Sipariş No	Fiyat/Birim	Ambalaj
-----	-------	-------------------------------------	------------	-------------	---------

Papuç Bağlantılı Klemensler

WFF 35	1100 / 109	2.5...50 mm ²	1028300000	147,70 TL	10
WFF 35 BL	1100 / 109	2.5...50 mm ²	1028380000	147,70 TL	10
WFF 70	1100 / 167	2.5...95 mm ²	1028400000	206,20 TL	10
WFF 70 BL	1100 / 167	2.5...95 mm ²	1028480000	206,20 TL	10
WFF 120	1100 / 234	16...150 mm ²	1028500000	295,50 TL	5
WFF 120 BL	1100 / 234	16...150 mm ²	1028580000	295,50 TL	5
WFF 185	1100 / 307	25...240 mm ²	1028600000	405,35 TL	4
WFF 185 BL	1100 / 307	25...240 mm ²	1028680000	405,35 TL	4
WFF 300	1100 / 425	50...300 mm ²	1028700000	481,10 TL	4

W Serisi Ray Klemensleri - Vida Bağlantı Teknolojisi



WEW 35/2



ZEW 35



WAP 2.5-10 BL



WAP 2.5-10



WAP 16+35 WTW 2.5-10



7AP/TW 1



WAP WDK 2.5N/TR-DU



WAH 35

Tip	Açıklama	Sipariş No	Fiyat/Birim	Ambalaj
Klemens Durdurucuları				
EW 35	Vidalı Küçük Tip	0383560000	6,00 TL	50
WEW 35/1	Vidalı Tip	1059000000	40,45 TL	50
WEW 35/2	Vidalı Tip	1061200000	25,30 TL	100
WEW 35/2 SW	Vidalı Tip Siyah	1061210000	25,30 TL	100
ZEW 35	Vidasız Tip 6mm Kalınlık	9540000000	6,06 TL	20
ZEW 35/2	Vidasız Tip 8mm Kalınlık	8630740000	6,90 TL	20
ZEW 35/2 SW	Vidasız Tip 8mm Kalınlık Siyah	1162610000	7,74 TL	20
EW 15	Vidalı Mini Tip	0382860000	5,94 TL	50
Nihayet Plakaları				
WAP 2.5-10	WDU 2.5-10 / WPE / WSI / WTR Serisi	1050000000	4,44 TL	50
WAP 2.5-10 BL	WDU 2.5-10 / WPE / WSI / WTR Serisi Mavi	1050080000	4,44 TL	50
WAP 16+35 WTW 2.5-10	WDU 16-35 Serisi	1050100000	6,30 TL	20
WAP 16+35 WTW 2.5-10 BL	WDU 16-35 Serisi Mavi	1050180000	6,30 TL	20
WAP WDU/WTR4/ZR	WTR4/ZR Serisi	1905070000	8,82 TL	50
WAP WDU/WTR4/ZZ	WTR4/ZZ Serisi	1905150000	8,82 TL	50
WAP WDK2.5	WDK 2.5 Serisi	1059100000	8,52 TL	20
WAP WDK2.5 BL	WDK 2.5 Serisi Mavi	1059180000	8,52 TL	20
WAP WDK10	WDK 10 Serisi	1186720000	19,40 TL	20
WAP WDK10 BL	WDK 10 Serisi Mavi	1186730000	19,10 TL	20
AP DLI2.5 DB	DLI / DLA Serisi	1783550000	13,45 TL	20
AP DLD2.5 DB	DLD Serisi	1784210000	13,45 TL	20
WAP WDL2.5	WDL Serisi	1067800000	8,04 TL	20
AP MAK2.5 DB	MAK Serisi	7917000000	16,15 TL	20
AP VLI1.5 DB	VLI 1.5 Serisi	1784150000	9,44 TL	20
AP VLI1.5/PE DB	VLI 1.5/PE Serisi	1784160000	10,00 TL	20
WAP WTR2.5/ZZ	WTR2.5/ZZ Serisi	1074600000	8,28 TL	20
ZAP/TW 1	ZDU 2.5	1608740000	4,86 TL	50
WAP WTL4/2	WTL 4/2 Serisi	1881640000	10,25 TL	50
WAP WTL6/1 EN	WTL 6/1 EN Serisi	1957710000	9,60 TL	20
WAP WTL6/1	WTL 6/1 Serisi	1068300000	7,74 TL	20
WAP WDK 2.5N/TR-DU	WDK 2.5N/TR-DU Serisi	1839850000	10,85 TL	50
WAP WSI4/2	WSI 4/2 Serisi	1880450000	3,78 TL	50
AP KDKS1 DB	KDKS 1/35 Serisi	9532470000	17,45 TL	20
WAP WDU2.5N/4N	WDU N Serisi 2.5-4	1060000000	5,22 TL	50
WAP WDU2.5N/4N BL	WDU N Serisi 2.5-4 Mavi	1060080000	5,22 TL	50
WAP WDK2.5/4 N	WDK N Serisi 2.5-4	1084000000	9,42 TL	20
WAP WDK2.5/4 N BL	WDK N Serisi 2.5-4 Mavi	1084080000	9,42 TL	20
TW SAKD2.5N	WDU2.5N Serisi Ayırma Plakası	0191860000	9,42 TL	20
WTW EN	WDU16N-35N Serisi Ayırma Plakası	1058800000	31,45 TL	20
WTW WTL6/1 DB	WTL6/1 Serisi Ayırma Plakası	1068400000	12,20 TL	20
WHP 2.5-35N/10x3 BL	WNT Serisi Bara Tutucu (10x3 mm Bara)	1050280000	9,84 TL	20
WAP WDU1.5/R3.5	WDU 1.5/R3.5 Serisi	1754190000	3,12 TL	20
WAP WDK1.5/R3.5	WDK 1.5/R3.5 Serisi	1754200000	10,70 TL	20
WFF Serisi Üst Kapak				
WAH 35	WFF 35 Üst Kapak	1064460000	23,75 TL	20
WAH 35 BL	WFF 35 Üst Kapak Mavi	1064480000	23,75 TL	20
WAH 70 BE	WFF 70 Üst Kapak	1064560000	28,30 TL	20
WAH 70 BL	WFF 70 Üst Kapak Mavi	1064580000	28,30 TL	20

Serinin devamı sayfa 7



WQV 2.5/2



WQV 2.5/10

Tip	Açıklama	Sipariş No	Fiyat/Birim	Ambalaj
WAH 120	WFF 120 Üst Kapak	1064660000	34,15 TL	20
WAH 120 BL	WFF 120 Üst Kapak Mavi	1064680000	34,15 TL	20
WAH 185/300 BE	WFF 185/300 Üst Kapak	1064760000	52,30 TL	10
WAH 185/300 BL	WFF 185/300 Üst Kapak Mavi	1064780000	52,30 TL	10

Tip	A	Kutup Sayısı	Sipariş No	Fiyat/Birim	Ambalaj
Vidalı Klemens Üst Köprü					
WQV 2.5/2	32	2 Kutup	1053660000	9,60 TL	50
WQV 2.5/3	32	3 Kutup	1053760000	13,50 TL	50
WQV 2.5/4	32	4 Kutup	1053860000	14,75 TL	50
WQV 2.5/5	32	5 Kutup	1053960000	17,35 TL	10
WQV 2.5/6	32	6 Kutup	1054060000	20,00 TL	10
WQV 2.5/7	32	7 Kutup	1054160000	23,05 TL	10
WQV 2.5/8	32	8 Kutup	1054260000	26,30 TL	10
WQV 2.5/9	32	9 Kutup	1054360000	29,50 TL	10
WQV 2.5/10	32	10 Kutup	1054460000	36,55 TL	20
WQV 2.5/15	32	15 Kutup	1059660000	50,75 TL	10
WQV 2.5/20	32	20 Kutup	1577570000	70,00 TL	10
WQV 2.5/32	32	32 Kutup	1577600000	110,45 TL	10
WQV 4/2	41	2 Kutup	1051960000	12,20 TL	50
WQV 4/3	41	3 Kutup	1054560000	17,95 TL	50
WQV 4/4	41	4 Kutup	1054660000	23,05 TL	50
WQV 4/5	41	5 Kutup	1057860000	25,70 TL	10
WQV 4/6	41	6 Kutup	1057160000	30,60 TL	10
WQV 4/7	41	7 Kutup	1057260000	35,40 TL	10
WQV 4/10	41	10 Kutup	1052060000	54,50 TL	20
WQV 6/2	57	2 Kutup	1052360000	12,20 TL	50
WQV 6/3	57	3 Kutup	1054760000	17,80 TL	50
WQV 6/4	57	4 Kutup	1054860000	23,05 TL	50
WQV 6/5	57	5 Kutup	1062660000	29,30 TL	50
WQV 6/6	57	6 Kutup	1062670000	34,75 TL	50
WQV 6/7	57	7 Kutup	1062680000	39,85 TL	50
WQV 6/10	57	10 Kutup	1052260000	54,50 TL	20
WQV 10/2	57	2 Kutup	1052560000	13,50 TL	50
WQV 10/3	57	3 Kutup	1054960000	19,20 TL	50
WQV 10/4	57	4 Kutup	1055060000	28,30 TL	50
WQV 10/10	57	10 Kutup	1052460000	62,15 TL	20
WQV 16/2	101/76	2 Kutup	1053260000	16,30 TL	50
WQV 16/3	101/76	3 Kutup	1055160000	22,40 TL	50
WQV 16/4	101/76	4 Kutup	1055260000	30,10 TL	50
WQV 16/10	101/76	10 Kutup	1053360000	68,10 TL	10
WQV 16N/2	101/76	2 Kutup	1636560000	16,15 TL	50
WQV 16N/3	101/76	3 Kutup	1636570000	22,40 TL	50
WQV 16N/4	101/76	4 Kutup	1636580000	30,10 TL	50
WQV 35/2	112	2 Kutup	1053060000	22,40 TL	50
WQV 35/3	112	3 Kutup	1055360000	30,10 TL	50
WQV 35/4	112	4 Kutup	1055460000	43,00 TL	50
WQV 35/10	112	10 Kutup	1053160000	102,10 TL	10
WQV 35N/2	101	2 Kutup	1079200000	33,40 TL	20
WQV 35N/3	101	3 Kutup	1079300000	46,90 TL	20
WQV 35N/4	101	4 Kutup	1079400000	66,20 TL	20
WQV 50N/2	150	2 Kutup	1834060000	65,50 TL	5

Serinin devamı sayfa 8

W Serisi Ray Klemensleri - Vida Bağlantı Teknolojisi



WQV 70/95/3



ZQV 2.5N/4 GE



ZQV 2.5N/2 GE



ZQV 2.5N/10 GE



ZQV 4N/10 GE



QL 4 SAK6N



STB 35 IH/GE

Tip	A	Kutup Sayısı	Sipariş No	Fiyat/Birim	Ambalaj
WQV 50N/3	150	3 Kutup	1834070000	91,90 TL	5
WQV 50N/4	150	4 Kutup	1834080000	120,05 TL	5
WQV 70N/2	192	2 Kutup	9512240000	84,80 TL	5
WQV 70N/3	192	3 Kutup	9512250000	123,35 TL	5
WQV 70N/4	192	4 Kutup	9531290000	155,50 TL	5
WQV 70/95/2	192	2 Kutup	1063500000	204,25 TL	5
WQV 70/95/3	192	3 Kutup	1063600000	331,45 TL	5
WQV 95N/120N/2	269	2 Kutup	1826890000	127,20 TL	5
WQV 95N/120N/3	269	3 Kutup	1826900000	176,75 TL	5
WQV 95N/120N/4	269	4 Kutup	1826910000	233,10 TL	5
WQV 120/2	269	2 Kutup	1063300000	246,70 TL	5
WQV 120/3	269	3 Kutup	1063400000	345,55 TL	5

Vidalı Klemens Tarak Üst Köprü

ZQV 2.5N/2 GE	24	2 Kutup	1693800000	4,92 TL	60
ZQV 2.5N/3 GE	24	3 Kutup	1693810000	8,52 TL	60
ZQV 2.5N/4 GE	24	4 Kutup	1693820000	12,20 TL	60
ZQV 2.5N/5 GE	24	5 Kutup	1693830000	15,10 TL	20
ZQV 2.5N/6 GE	24	6 Kutup	1693840000	19,10 TL	20
ZQV 2.5N/7 GE	24	7 Kutup	1693850000	22,75 TL	20
ZQV 2.5N/8 GE	24	8 Kutup	1693860000	26,45 TL	20
ZQV 2.5N/9 GE	24	9 Kutup	1693870000	30,10 TL	20
ZQV 2.5N/10 GE	24	10 Kutup	1693880000	34,15 TL	20
ZQV 2.5N/20 GE	24	20 Kutup	1909000000	67,45 TL	20
ZQV 4N/2 GE	32	2 Kutup	1758250000	9,60 TL	60
ZQV 4N/3 GE	32	3 Kutup	1762630000	13,80 TL	60
ZQV 4N/4 GE	32	4 Kutup	1762620000	19,20 TL	60
ZQV 4N/10 GE	32	10 Kutup	1758260000	45,60 TL	20
ZQV 4N/20 GE	32	20 Kutup	1909020000	75,70 TL	20

Tip	Açıklama	Sipariş No	Fiyat/Birim	Ambalaj
-----	----------	------------	-------------	---------

Vidalı Klemens Tarak Üst Köprü

ZQV 1.5N/R3.5/2 GE	WDU 1.5 - WDK 1.5 Serisi / 2 Kutup	1754210000	4,92 TL	50
ZQV 1.5N/R3.5/3 GE	WDU 1.5 - WDK 1.5 Serisi / 3 Kutup	1754220000	10,00 TL	50
ZQV 1.5N/R3.5/4 GE	WDU 1.5 - WDK 1.5 Serisi / 4 Kutup	1754230000	14,75 TL	20
ZQV 1.5N/R3.5/10 GE	WDU 1.5 - WDK 1.5 Serisi / 10 Kutup	1754290000	41,80 TL	20

Tip	A	Kutup Sayısı	Sipariş No	Fiyat/Birim	Ambalaj
-----	---	--------------	------------	-------------	---------

WSI 6 Serisi Bara Köprü

QL 2 SAK6N	24	2 Kutup	0194300000	3,82 TL	50
QL 3 SAK6N	24	3 Kutup	0194400000	6,00 TL	50
QL 4 SAK6N	24	4 Kutup	0194500000	7,00 TL	50
QL 10 SAK6N	24	10 Kutup	0338300000	15,00 TL	20
KISC M3X5	24	Köprü Vidası	1052100000	1,48 TL	100
WAW 2	Klemens Köprü Açma El Aleti		9004510000	998,00 TL	1

Tip	Açıklama	Sipariş No	Fiyat/Birim	Ambalaj
-----	----------	------------	-------------	---------

WTL 6/1 Serisi Aksesuar

STB 25 IH/GE	Test Soketi Girişli Ölçüm Alma Vidası - Sarı	0267200000	20,16 TL	50
BS 25 IH/GE SAKT1	Ayrırma Vidası - Sarı	0335700000	12,00 TL	50
STB 35 IH/GE	Test Soketi Girişli Ayrırma Vidası - Sarı	0389000000	24,42 TL	50
STB 14/D6/4/M3 SAK10	Ölçüm Kovanı - Vidalı	0169900000	4,44 TL	50

Serinin devamı sayfa 9



WKS 1/2



VQB 1.5/50 BL

Tip	Açıklama	Sipariş No	Fiyat/Birim	Ambalaj
VH 19/6/4.2 SAKT1	Vida Kovanı	0318000000	11,52 TL	50
SSP 3 SAKT1	İzolasyon Kapağı	0531760000	7,44 TL	100
QVS 2 SAKT1+2	Sürgülü Ölçme-Ayırma Köprüsü	0307300000	28,98 TL	20
QB 58/8/9/WI	Tarak Köprü - Kablo Bağlantı Noktasından	0545300000	110,00 TL	10
ISPF QB58 SW	Köprü İzolasyonu	0546000000	17,34 TL	10
WKS 1/2	WTL 6/2 Sürgü Köprü - İki Kutup - 1017700000 için	1604270000	23,05 TL	50
Tip	Kutup Sayısı	Sipariş No	Fiyat/Birim	Ambalaj
MAK / VLI Serisi Klemens Tarak Köprü				
VQB 1.5/50 BL	50 Kutup - Mavi	1633280000	160,00 TL	5
VQB 1.5/50 RT	50 Kutup - Kırmızı	1633290000	123,35 TL	5

Bara-Ekranlama -Cihaz Sıra Ve Panel Klemensleri



ZB 10 F.10X3/10X5/10X10



ZF 4 S



SH 2 S



KLBUE CO 1



MK 3/12



MK 6/6



WGK 4

Tip	Kesit	Sipariş No	Fiyat/Birim	Ambalaj	
Bara Klemensleri					
İzolesiz Bara Klemensleri (10x3 mm'lik Bara için)					
ZB 4	0.5 - 4 mm ²	0316500000	5,52 TL	50	
ZBE 6	2.5 - 6 mm ²	0459500000	9,60 TL	50	
ZB 10 F.10X3/10X5/10X10	1.5 - 10 mm ²	1261300000	9,60 TL	50	
ZB 16 ZKSC	2.5 - 16 mm ²	0316600000	10,68 TL	50	
ZB 35/M6X16	16 - 35 mm ²	0266500000	13,50 TL	20	
İzoleli Bara Klemensleri (10x3 mm'lik Bara için)					
ZB 4K BL	0.5 - 4 mm ²	0475380000	8,34 TL	50	
ZB 4K GE/GN	0.5 - 4 mm ²	0475360000	10,08 TL	50	
ZBE 6K BL	2.5 - 6 mm ²	0525980000	14,52 TL	50	
ZBE 6K GE/GN	2.5 - 6 mm ²	0525960000	14,52 TL	50	
ZB 16K BL	2.5 - 16 mm ²	0502880000	15,36 TL	50	
ZB 16K GE/GN	2.5 - 16 mm ²	0502860000	15,36 TL	50	
ZB 35K BL M6X16	16 - 35 mm ²	0502680000	21,24 TL	20	
ZB 35K GE/GN M6X16	16 - 35 mm ²	0502660000	21,24 TL	20	
Yayı İzoleli Bara Klemensleri (10x3 mm'lik Bara için)					
ZF 4 S	0.5 - 4 mm ²	1814680000	11,40 TL	50	
ZF 4 S BL	0.5 - 4 mm ²	1814660000	11,40 TL	50	
ZF 4 S GN	0.5 - 4 mm ²	1814670000	11,40 TL	50	
SSCH 10X3X1000 CU/SN	10x3 Bakır Bara	3489000000	157,90 TL	1M	
Bara Tutucular					
SH 1	10x3 / 6x6 / 15x2x12x2 mm	0299860000	17,34 TL	20	
SH 2 S	10x3 / 6x6 / 15x6x10x5 mm	0641720000	53,94 TL	10	
SH 3	10x3 / 6x6 / 10x5 mm	0556660000	27,66 TL	10	
Ekranlama Klemensleri					
KLBUE CO 1	Ø 3...10 mm	1753311001	59,80 TL	10	
KLBUE CO 2	Ø 4...15 mm	1752131001	70,00 TL	10	
KLBUE CO 3	Ø 10...20 mm	1749151001	95,10 TL	10	
KLBUE CO 4	Ø 15...28 mm	1749161001	131,70 TL	10	
KLBUE CO 5	Ø 20...37 mm	1755081001	216,00 TL	10	
Cihaz Sıra Klemensleri					
Tip	V / A	Açıklama	Sipariş No	Fiyat/Birim	Ambalaj
MK 3/2	400 / 24	0.5 - 4 mm ² / 2 Kutup	0273820000	20,00 TL	100
MK 3/3	400 / 24	0.5 - 4 mm ² / 3 Kutup	0273920000	21,84 TL	50
MK 3/4	400 / 24	0.5 - 4 mm ² / 4 Kutup	0274020000	29,52 TL	50
MK 3/6	400 / 24	0.5 - 4 mm ² / 6 Kutup	0274220000	40,44 TL	50
MK 3/8	400 / 24	0.5 - 4 mm ² / 8 Kutup	0274420000	73,32 TL	25
MK 3/10	400 / 24	0.5 - 4 mm ² / 10 Kutup	0274620000	76,38 TL	20
MK 3/12	400 / 24	0.5 - 4 mm ² / 12 Kutup	0243520000	80,40 TL	20
MK 6/2	690 / 21	0.5 - 6 mm ² / 2 Kutup	0620420000	47,52 TL	50
MK 6/3	690 / 21	0.5 - 6 mm ² / 3 Kutup	0620320000	66,18 TL	50
MK 6/4	690 / 21	0.5 - 6 mm ² / 4 Kutup	0620220000	76,38 TL	20
MK 6/6	690 / 21	0.5 - 6 mm ² / 6 Kutup	0620120000	109,20 TL	20
Panel Geçiş Klemensleri					
WGK 4	250 / 32	0.5 - 6 mm ²	1936550000	23,00 TL	50
WGK 95	690 / 232	35 - 95 mm ²	1937380000	210,00 TL	10

Tip	V / A	Kesit (Yüksüksüz)	Sipariş No	Fiyat/Birim	Ambalaj
WMF Serisi Geçiş Klemensleri					
WMF 2.5	800 / 24	0.5 - 4 mm ² / Geçiş Klemensi	1143070000	16,15 TL	50
WMF 2.5 BL	800 / 24	0.5 - 4 mm ² / Geçiş Klemensi / Mavi	1270040000	16,15 TL	50
WMF 2.5 DI	800 / 24	0.5 - 4 mm ² / Ayırma Klemensi	1143020000	59,15 TL	50
WMF 2.5 DI BL	800 / 24	0.5 - 4 mm ² / Ayırma Klemensi / Mavi	1270070000	59,15 TL	50
WMF 2.5 DI PE	800 / 24	0.5 - 4 mm ² / Ayırma Klemensi / Toprak	1143030000	105,40 TL	50
WMF 2.5 DI PE BL	800 / 24	0.5 - 4 mm ² / Ayırma Klemensi / Toprak / Mavi	1270080000	105,40 TL	50
Ayrma Sistem Sigortalı Klemens					
WMF 2.5 FU SW	250 / 6.3	0.5 - 4 mm ²	1162920000	89,95 TL	50
WMF 2.5 FU 10-36V SW	250 / 6.3	0.5 - 4 mm ² / 10-36V LED	1162930000	138,70 TL	50
WMF 2.5 FU 30-70V SW	250 / 6.3	0.5 - 4 mm ² / 30-70V LED	1162940000	139,40 TL	50
WMF 2.5 FU 60-150V SW	250 / 6.3	0.5 - 4 mm ² / 60-150V LED	1162950000	139,40 TL	50
WMF 2.5 FU 100-250V SW	250 / 6.3	0.5 - 4 mm ² / 100-250V LED	1162960000	138,70 TL	50
WMF 2.5 FU PE SW	250 / 6.3	0.5 - 4 mm ² / İki Kat Alt Toprak	1163040000	132,90 TL	50
WMF 2.5 FU PE 10-36V SW	250 / 6.3	0.5 - 4 mm ² / 10-36V LED / İki Kat Alt Toprak	1163050000	251,90 TL	50
WMF 2.5 FU PE 30-70V SW	250 / 6.3	0.5 - 4 mm ² / 30-70V LED / İki Kat Alt Toprak	1163060000	253,10 TL	50
WMF 2.5 FU PE 60-150V SW	250 / 6.3	0.5 - 4 mm ² / 60-150V LED / İki Kat Alt Toprak	1163070000	253,10 TL	50
WMF 2.5 FU PE 100-250V SW	250 / 6.3	0.5 - 4 mm ² / 100-250V LED / İki Kat Alt Toprak	1163080000	252,50 TL	50
BLZ Bağlantı Noktalı Geçiş ve Sigortalı Klemensler					
WMF 2.5 BLZ	250 / 24	0.5 - 4 mm ² / Geçiş Klemensi	1143050000	27,65 TL	50
WMF 2.5 DI BLZ	250 / 24	0.5 - 4 mm ² / Ayırma Klemensi	1143000000	66,85 TL	50
WMF 2.5 DI BLZ PE	250 / 24	0.5 - 4 mm ² / Ayırma Klemensi / Toprak	1143010000	123,95 TL	50
WMF 2.5 FU BLZ SW	250 / 24	0.5 - 4 mm ²	1162980000	115,55 TL	50
WMF 2.5 FU BLZ 10-36V SW	250 / 24	0.5 - 4 mm ² / 10-36V LED	1162990000	210,00 TL	50
WMF 2.5 FU BLZ 30-70V SW	250 / 24	0.5 - 4 mm ² / 30-70V LED	1163000000	210,00 TL	50
WMF 2.5 FU BLZ 60-150V SW	250 / 24	0.5 - 4 mm ² / 60-150V LED	1163010000	210,00 TL	50
WMF 2.5 FU BLZ 100-250V SW	250 / 24	0.5 - 4 mm ² / 100-250V LED	1163020000	210,00 TL	50
WMF 2.5 FU BLZ PE SW	250 / 24	0.5 - 4 mm ² / İki Kat Alt Toprak	1162820000	160,55 TL	50
WMF 2.5 FU BLZ PE 10-36V SW	250 / 24	0.5 - 4 mm ² / 10-36V LED / İki Kat Alt Toprak	1162830000	279,95 TL	50
WMF 2.5 FU BLZ PE 30-70V SW	250 / 24	0.5 - 4 mm ² / 30-70V LED / İki Kat Alt Toprak	1162840000	279,95 TL	50
WMF 2.5 FU BLZ PE 60-150V SW	250 / 24	0.5 - 4 mm ² / 60-150V LED / İki Kat Alt Toprak	1162850000	279,95 TL	50
WMF 2.5 FU BLZ PE 100-250V SW	250 / 24	0.5 - 4 mm ² / 100-250V LED / İki Kat Alt Toprak	1162860000	279,95 TL	50
İki ve Üç Katlı Ayırma ve Sigorta Sistem Klemensler					
WDK 2.5/TR-DU	690 / 24	0.5 - 2.5 mm ² / Test ayırma / İki Katlı	1247290000	75,10 TL	50
WDK 2.5/TR-DU STB	690 / 24	0.5 - 2.5 mm ² / Test ayırma / Test Soket / İki Katlı	1247310000	84,80 TL	50
WDK 2.5/TR-DU-PE	690 / 24	0.5 - 2.5 mm ² / Test ayırma / Üç Katlı	1247420000	120,80 TL	50
WDK 2.5/TR-DU-PE STB	690 / 24	0.5 - 2.5 mm ² / Test ayırma / Test Soket / Üç Katlı	1247430000	133,50 TL	50
WDK 2.5/TR-DU/o TNHE	690 / 24	0.5 - 4 mm ² / İki Kat / SIHA ve BEST modü	1833600000	66,20 TL	50
WDK 2.5/TR-DU/o TNHE StB	690 / 24	0.5 - 4 mm ² / İki Kat / SIHA ve BEST modü	1833610000	75,10 TL	50
WDK 2.5/TR-DU-PE/o TNHE	690 / 24	0.5 - 4 mm ² / Üç Kat / SIHA ve BEST modül / Toprak	1833640000	106,55 TL	50
SIHA 3/G20	400	Sigorta Modül	7921560000	32,10 TL	25
SIHA 3/G20/LD 10-36V	10 - 36	10-36V AC-DC Led Sigorta Modül	7921570000	70,00 TL	25
SIHA 3/G20/LD 140-250V	140 - 250	140-250V Led Sigorta Modül	7921600000	75,70 TL	25
BEST		Boş Modül	1833100000	52,70 TL	50
BEST/DRBR	400 / 41	Jumper Modül	1878570000	67,45 TL	50
BEST/D	Max 250	WTR 2.5/ 1N4007 diyotlu fiş	1878560000	70,00 TL	50



WMF 2.5



WMF 2.5 DI



WMF 2.5 FU SW



WMF 2.5 BLZ



WDK 2.5/TR-DU



WDK 2.5/TR-DU-PE



SIHA 3/G20

WMF Serisi Marshalling Ray Klemensleri - Vida Bağlantı Teknolojisi



AP WMF2.5



WAP WDK 2.5N/TR-DU



BLZP 5.08HC/04/90 SN OR BX

Tip	Açıklama	Sipariş No	Fiyat/Birim	Ambalaj
Nihayet Plakası - BLZ Klemensler				
AP WMF2.5	WMF Serisi	1142990000	10,55 TL	50
WAP WDK 2.5N/TR-DU	WDK 2.5N/TR-DU Serisi	1839850000	10,85 TL	50
BLZ Klemensler				
BLZP 5.08HC/02/90 SN OR BX	2 Kutup	1948000000	10,55 TL	180
BLZP 5.08HC/04/90 SN OR BX	4 Kutup	1948020000	21,25 TL	90
BLZP 5.08HC/08/90 SN OR BX	8 Kutup	1948060000	41,80 TL	42
BLZP 5.08HC/12/90 SN OR BX	12 Kutup	1948110000	62,95 TL	30
BLZP 5.08HC/16/90 SN OR BX	16 Kutup	1948150000	84,20 TL	18

Z Serisi Ray Klemensleri - Yaylı Bağlantı Teknolojisi

0.13 - 35 mm² arası iletkenlerin Z serisi yaylı klemenslere bağlantısı pratik bir şekilde gerçekleştirilir.

Z serisi yay bağlantılı klemensler müşteri istekleri doğrultusunda tasarlanmıştır;

- Küçük Tasarım
- Geniş Markalama Alanları
- Klemensle Bütünleştirilmiş Test Noktaları
- Üst Köprüler Z Serisi ve Diğer Serilerle Kullanılabilir.

Z serisi klemensler oldukça geniş sıkıştırma kesiti aralığına sahiptir ve iki kanal köprüleme yapmaya olanak verir. Bu sayede istenilen sayıda köprüleme yapılabilir.

Aşağıdaki versiyonlarda üretilmişlerdir :

Z-Standart

- 0,05 - 35 mm² arası iletken kesiti
- Tornavida yönünün paralelinde üstten iletken girişi

Bazı Klemens Tipleri:

- **ZDU** - Geçiş Klemensleri
- **ZPE** - Topraklama Klemensleri
- **ZNT** - Nötr Klemensleri
- **ZDL** - Üç İletkenli Dağıtım Klemensleri
- **ZTR** - Ölçme Ayırma Klemensleri
- **ZSI** - Sigortalı Klemensler
- **ZDK** - Çok Katlı Klemensler

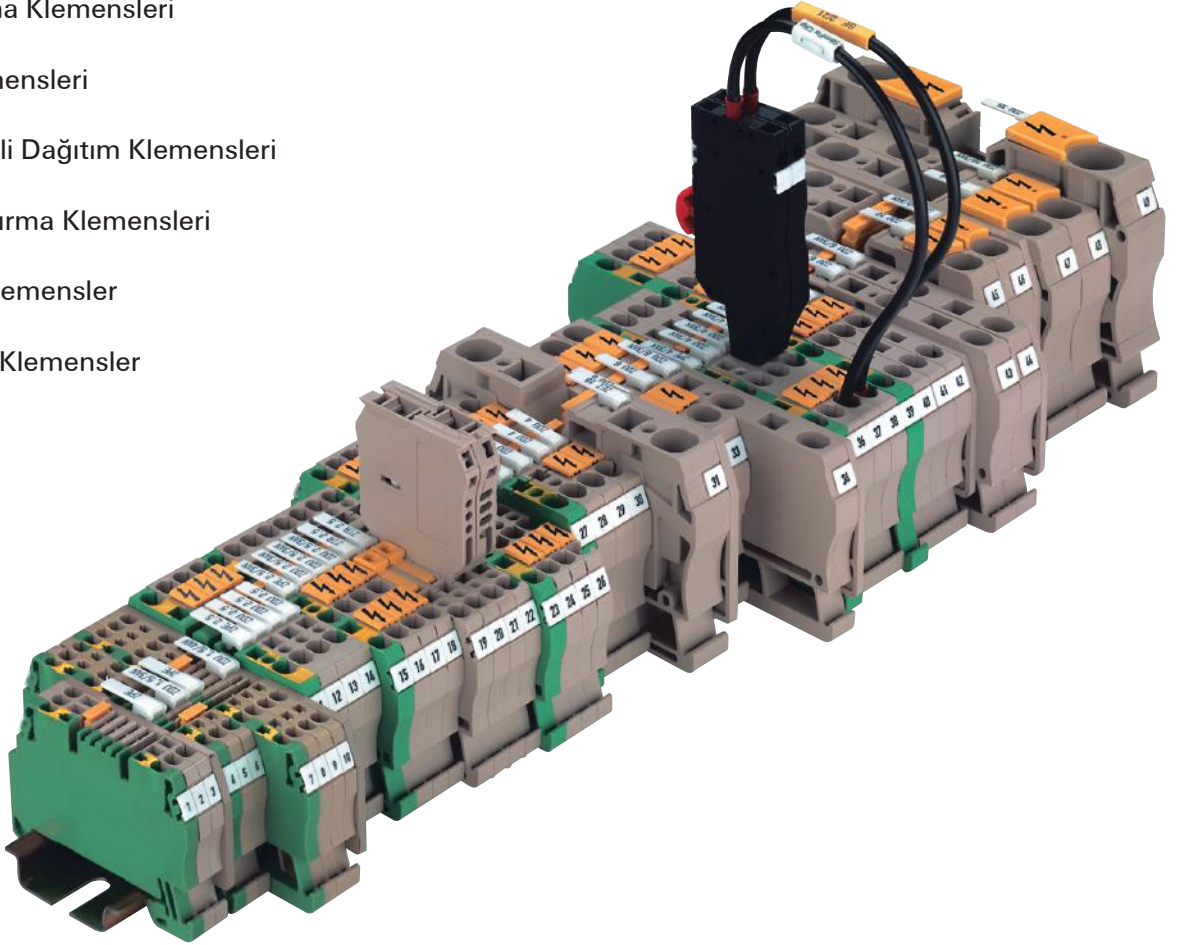

Z Serisi Ray Klemensleri - Yaylı Bağlantı Teknolojisi

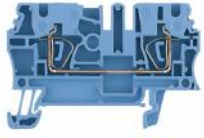

ZDU 2.5 BL



ZDU 2.5



ZDU 2.5 GE



ZDU 35



ZDU 2.5/3AN



ZDK 2.5



ZMAK 2.5



ZPE 2.5

Tip	V / A	Kesit (Yüksüksüz)	Sipariş No	Fiyat/Birim	Ambalaj
Z Serisi Geçiş Klemensleri					
ZDU 2.5	800 / 24	0.5 - 4 mm ²	1608510000	5,22 TL	100
ZDU 2.5 BL	800 / 24	0.5 - 4 mm ²	1608520000	5,22 TL	100
ZDU 1.5	500 / 17.5	0.5 - 1.5 mm ²	1775480000	6,48 TL	100
ZDU 1.5 BL	500 / 17.5	0.5 - 1.5 mm ²	1775490000	6,48 TL	100
ZDU 4	800 / 32	0.5 - 6 mm ²	1632050000	7,08 TL	100
ZDU 4 BL	800 / 32	0.5 - 6 mm ²	1632060000	7,08 TL	100
ZDU 6	800 / 41	1.5 - 10 mm ²	1608620000	11,90 TL	50
ZDU 6 BL	800 / 41	1.5 - 10 mm ²	1608630000	11,90 TL	50
ZDU 10	1000 / 57	1.5 - 16 mm ²	1746750000	17,00 TL	25
ZDU 10 BL	1000 / 57	1.5 - 16 mm ²	1746760000	16,90 TL	25
ZDU 16	1000 / 76	2.5 - 25 mm ²	1745230000	23,00 TL	25
ZDU 16 BL	1000 / 76	2.5 - 25 mm ²	1745240000	23,00 TL	25
ZDU 35	800 / 125	2.5 - 35 mm ²	1739620000	150,30 TL	10
ZDU 35 BL	800 / 125	2.5 - 35 mm ²	1739630000	150,30 TL	10

Renk Tipleri

	Bej	Mavi	Turuncu	Kahverengi	Sarı	Yeşil	Gri	Kırmızı	Siyah	Pembe	Beyaz
ZDU 2.5	160851	160852	163678	168330	168327	168328	168331	168326	168333	168329	168332
ZDU 4	163205	163206	163683	168362	168359	-	168363	168358	168365	-	168364
ZDU 6	160862	160863	163682	-	-	-	-	-	-	-	-
ZDU 10	174675	174676	183061	-	-	-	-	-	-	-	-
ZDU 16	174523	174524	183068	-	-	-	-	-	-	-	-
ZDU 35	173962	173963	183076	-	-	-	-	-	-	-	-

Tip	V / A	Kesit (Yüksüksüz)	Sipariş No	Fiyat/Birim	Ambalaj
İkili Geçiş Klemensleri					
ZDU 2.5/3AN	800 / 24	0.5 - 4 mm ²	1608540000	11,20 TL	100
ZDU 2.5/4AN	800 / 24	0.5 - 4 mm ²	1608570000	14,50 TL	100
ZDU 2.5/2X2AN	800 / 24	0.5 - 4 mm ²	1608600000	23,75 TL	100
ZDU 4/3AN	800 / 32	1.5 - 6 mm ²	7904180000	16,15 TL	50
ZDU 4/4AN	800 / 32	1.5 - 6 mm ²	7904290000	19,50 TL	50

İki Katlı Klemensler

ZDK 1.5	500 / 17.5	0.5 - 1.5 mm ²	1791100000	15,10 TL	100
ZDK 1.5DU-PE	500 / 17.5	0.5 - 1.5 mm ²	1791120000	37,90 TL	100
ZDK 2.5	800 / 24	0.5 - 2.5 mm ²	1674300000	15,50 TL	50
ZDK 2.5DU-PE	800 / 24	0.5 - 2.5 mm ²	1689970000	55,20 TL	50
ZDK 6S/L/L	800 / 41	1.5 - 6 mm ²	1733260000	55,20 TL	25

Üç Katlı Klemensler (Her Üç Kat Köprülenebilir)

ZDLD 2.5-2N	500 / 20	0.5 - 2.5 mm ²	1782300000	43,75 TL	50
ZDLD 2.5-2N/PE/L/L	500 / 20	0.5 - 2.5 mm ²	1131750000	75,10 TL	50
ZDLD 2.5-2N/PE/L/N	500 / 20	0.5 - 2.5 mm ²	1131760000	75,10 TL	50
ZDLD 2.5-2N PE	500 / 20	0.5 - 2.5 mm ² / Üç Kat Köprülü Toprak	1131740000	83,45 TL	50
ZVLD 2.5	250 / 24	0.5 - 2.5 mm ² / Dört Katlı Klemens	1208920000	79,60 TL	50
ZMAK 2.5	250 / 24	0.5 - 2.5 mm ² / Dört Katlı / 3 Faz - 1 PE	1768000000	79,60 TL	25

Topraklama Klemensleri

ZPE 2.5	800	0.5 - 4 mm ²	1608640000	23,50 TL	50
ZPE 4	800	0.5 - 6 mm ²	1632080000	30,05 TL	50
ZPE 6	800	1.5 - 10 mm ²	1608670000	37,20 TL	50
ZPE 10	800	1.5 - 16 mm ²	1746770000	46,90 TL	25
ZPE 16	800	2.5 - 25 mm ²	1745250000	61,60 TL	25
ZPE 35	800	2.5 - 35 mm ²	1739650000	242,80 TL	10



ZDUA 2.5-2



ZEW 15



ZTR 2.5



ZSI 2.5



ZSI 2.5-2/2X2AN/G20



ZTR 2.5/0.TNHE



SIHA 3/G20



ZPV 1.5



ZIA 1.5/3L-1S/LD-RT

Tip	V / A	Kesit (Yüksüksüz)	Sipariş No	Fiyat/Birim	Ambalaj
Z Serisi Mini Klemens					
ZDUA 2.5-2	500 / 24	0.5 - 2.5 mm ²	1720920000	12,90 TL	100
ZDUA 2.5-2 BL	500 / 24	0.5 - 2.5 mm ² / Mavi	1720930000	12,90 TL	100

Tip	V / A	Kesit (Yüksüksüz)	Sipariş No	Fiyat/Birim	Ambalaj
Z Serisi Mini Topraklama Klemens					
ZPEA 2.5-2	500	0.5 - 2.5 mm ²	1720950000	25,10 TL	100

Tip	Açıklama	Sipariş No	Fiyat/Birim	Ambalaj
Mini Klemens Durdurucuları				
ZEW 15	Vidasız Durdurucu	7920340000	5,52 TL	20

Tip	V / A	Kesit (Yüksüksüz)	Sipariş No	Fiyat/Birim	Ambalaj
Ölçme Ayırma Klemensleri					
ZTR 2.5	500 / 20	0.5 - 4 mm ²	1831280000	37,20 TL	50
ZTR 2.5/3AN	500 / 20	0.5 - 4 mm ²	8731720000	34,75 TL	50
ZDTR 2.5	400 / 16	0.5 - 4 mm ² / İki Kat / İki Kat Ayırma	1745400000	102,10 TL	20
ZTD 6	800 / 41	1.5 - 6 mm ² / Direk Besleme	1771810000	59,15 TL	20
ZTD 6/STB	800 / 41	1.5 - 6 mm ² / Direk Besleme / Test Soket	1771960000	54,50 TL	20
ZTL 6	800 / 41	1.5 - 6 mm ² / Sürgü Ayırma	1771800000	61,60 TL	20
ZTL 6/STB	800 / 41	1.5 - 6 mm ² / Sürgü Ayırma / Test Soket	1771950000	86,10 TL	20

Tip	V / A	Kesit (Yüksüksüz)	Sipariş No	Fiyat/Birim	Ambalaj
Sigortalı Klemensler ve Modüller					
ZSI 2.5	500 / 6.3	0.5 - 4 mm ² / 5X20 Sigorta	1616400000	46,25 TL	50
ZSI 2.5/LD 28AC	... / 6.3	0.5 - 4 mm ² / 5X20 Sigorta / LED	1616440000	110,45 TL	50
ZSI 2.5/LD 60AC	... / 6.3	0.5 - 4 mm ² / 5X20 Sigorta / LED	1616430000	110,45 TL	50
ZSI 2.5/LD 120AC	... / 6.3	0.5 - 4 mm ² / 5X20 Sigorta / LED	1616420000	110,45 TL	50
ZSI 2.5/LD 250AC	... / 6.3	0.5 - 4 mm ² / 5X20 Sigorta / LED	1616410000	110,45 TL	50
ZSI 2.5/5X25	500 / 6.3	0.5 - 4 mm ² / 5X25 Sigorta	1730900000	49,45 TL	50
ZSI 2.5-2/2X2AN/G20	500 / 27	0.5 - 4 mm ² / 5X25 Sigorta / Hazardous Bölge	1826050000	86,10 TL	20
ZSI 6-2 2X2.5/G20	500 / 24	0.5 - 4 mm ² / 5X25 Sigorta / Hazardous Bölge	1820930000	86,10 TL	20
ZSI 2.5-2/2X2AN/G20/LD4	500 / 10	0.5 - 4 mm ² / 5X25 Sigorta / Hazardous Bölge / Led	1879730000	118,25 TL	20
ZSI 6-2 2X2.5/G20/LD4	500 / 10	0.5 - 4 mm ² / 5X25 Sigorta / Hazardous Bölge / Led	1879750000	116,90 TL	20
ZSI 6-2/FC	250 / 30	0.5 - 10 mm ² / Oto Sigorta Tip Klemens	1814690000	109,85 TL	25
ZSI 6-2/FC LD	250 / 30	0.5 - 10 mm ² / Oto Sigorta Tip Klemens / Led	1814700000	149,05 TL	25
ZTR 2.5/0.TNHE	500 / 20	SIHA ve BEST modül için	1831130000	32,70 TL	50
ZDL 2.5/SI/DU	500 / 20	SIHA ve BEST modül için / İki Katlı / Üst Kat Sigortalı	1763180000	86,10 TL	25
SIHA 3/G20	400	Sigorta Modül	7921560000	32,10 TL	25
SIHA 3/G20/LD 10-36V	10 - 36	10-36V AC-DC Led Sigorta Modül	7921570000	70,00 TL	25
SIHA 3/G20/LD 140-250V	140 - 250	140-250V Led Sigorta Modül	7921600000	75,70 TL	25
BEST		Boş Modül	1833100000	52,70 TL	50
BEST/DRBR	400 / 41	Jumper Modül	1878570000	67,45 TL	50
BEST/D	Max 250	WTR 2.5/ 1N4007 diyotlu fiş	1878560000	70,00 TL	50

Tip	V / A	Kesit (Yüksüksüz)	Sipariş No	Fiyat/Birim	Ambalaj
Sigortalar					
G 20/0.25A/F	0.25	Sigorta	0430500000	12,12 TL	10
G 20/0.50A/F	0.5	Sigorta	0430600000	14,00 TL	10
G 20/1.00A/F	1	Sigorta	0430700000	12,12 TL	10
G 20/2.00A/F	2	Sigorta	0430900000	12,12 TL	10

Tip	V / A	Kesit (Yüksüksüz)	Sipariş No	Fiyat/Birim	Ambalaj
Sensör - Aktüatörler İçin Köprü Gerektirmeyen Modüler Yaylı Klemensler					
ZPV 1.5	250 / 17.5	Dört Bölüm Boş Taban	1676630000	9,42 TL	100
ZIA 1.5/3L-1S	250 / 17.5	0.5 - 2.5 mm ² / İki Bölüm / İkilili Geçiş	1651980000	20,60 TL	100
ZIA 1.5/3L-1S/LD-RT	250 / 17.5	0.5 - 2.5 mm ² / İki Bölüm / İkilili Geçiş / Led	1651990000	62,95 TL	50
ZIA 1.5/3L-PE	250 / 17.5	0.5 - 2.5 mm ² / İki Bölüm / Toprak	1652000000	93,70 TL	20
ZIA 1.5/4L-1S	250 / 17.5	0.5 - 2.5 mm ² / Üç Bölüm / İkilili Geçiş	1652010000	21,85 TL	100
ZIA 1.5/4L-1S/LD	250 / 17.5	0.5 - 2.5 mm ² / Üç Bölüm / İkilili Geçiş / Led	1652020000	49,45 TL	50

Serinin devamı sayfa 16

Z Serisi Ray Klemensleri - Yaylı Bağlantı Teknolojisi



ZVL 1.5



ZEW 35



ZAP/TW 1



ZAP/TW ZDU1.5/2AN



ZAP/TW 3



ZQV 1.5/2



ZQV 1.5/4



ZQV 2.5/2

Tip	V / A	Kesit (Yüksüksüz)	Sipariş No	Fiyat/Birim	Ambalaj
ZIA 1.5/4L-PE	250 / 17.5	0.5 - 2.5 mm ² / Üç Bölüm / Toprak	1652030000	93,70 TL	20
ZVL 1.5	250 / 17.5	0.5 - 2.5 mm ² / Dağıtım Klemens	1649300000	9,42 TL	100
ZVL 1.5 BL	250 / 17.5	0.5 - 2.5 mm ² / Dağıtım Klemens / Mavi	1650360000	11,20 TL	100
ZVL 1.5 BR	250 / 17.5	0.5 - 2.5 mm ² / Dağıtım Klemens / Kahverengi	1650370000	11,20 TL	100
ZVL 1.5 0.QV	250 / 17.5	0.5 - 2.5 mm ² / Dağıtım Klemens	1711930000	11,50 TL	100
ZVL 1.5/PE GN/GE BED	250 / 17.5	0.5 - 2.5 mm ² / Dağıtım Klemens / Toprak	1651970000	11,20 TL	100

Tip	Açıklama	Sipariş No	Fiyat/Birim	Ambalaj
Klemens Durdurucuları				
ZEW 35	Vidasız Tip 6mm Kalınlık	9540000000	6,06 TL	20
ZEW 35/2	Vidasız Tip 8mm Kalınlık	8630740000	6,90 TL	20
ZEW 35/2 SW	Vidasız Tip 8mm Kalınlık Siyah	1162610000	7,74 TL	20

Tip	Açıklama	Sipariş No	Fiyat/Birim	Ambalaj
Nihayet Plakaları				
ZAP/TW 1	ZDU 2.5	1608740000	4,86 TL	50
ZAP/TW 1 BL	ZDU 2.5 Mavi Serisi	1608750000	4,86 TL	50
ZAP/TW ZDU1.5/2AN	ZDU 1.5 Serisi	1776030000	4,38 TL	20
ZAP/TW ZDU1.5/2AN BL	ZDU 1.5 Mavi Serisi	1776040000	4,38 TL	20
ZAP/TW 4	ZDU 4 Serisi	1632090000	4,86 TL	50
ZAP/TW 4 BL	ZDU 4 Mavi Serisi	1632100000	4,86 TL	50
ZAP/TW 5	ZDU 6 Serisi	1608830000	4,86 TL	50
ZAP/TW 5 BL	ZDU 6 Mavi Serisi	1608840000	4,86 TL	50
ZAP/TW ZDU10	ZDU 10 Serisi	1748660000	5,46 TL	20
ZAP/TW ZDU10 BL	ZDU 10 Mavi Serisi	1764110000	5,22 TL	20
ZAP/TW ZDU16	ZDU 16 Serisi	1745150000	7,74 TL	20
ZAP/TW ZDU16 BL	ZDU 16 Mavi Serisi	1764100000	7,74 TL	20
ZAP/TW ZDK1.5	ZDK 1.5 Serisi	1791160000	4,92 TL	20
ZAP/TW ZDK2.5	ZDK 2.5 Serisi	1674730000	10,00 TL	20
ZAP/TW ZDK2.5 BL	ZDK 2.5 Mavi Serisi	1748800000	8,34 TL	20
ZAP/TW ZDL2.5-2N	ZDLD 2.5 Serisi	1782340000	7,74 TL	20
ZAP ZVLD 2.5	ZVLD 2.5 Serisi	1210410000	7,57 TL	10
ZAP ZMAK2.5	ZMAK 2.5 Serisi	1768010000	12,20 TL	10
ZAP/TW 2 DB	ZTR 2.5 - ZDU 2.5/3 AN Serisi	1608770000	5,46 TL	50
ZAP/TW 3	ZSI 2.5 - ZDU 2.5/4 AN Serisi	1608800000	5,46 TL	50
ZAP/TW 4/3AN	ZDU 4/3AN Serisi	7904100000	7,44 TL	20
ZAP/TW4/4AN	ZDU 4/4AN Serisi	7904210000	7,44 TL	20
ZAP TNHE/ZSI2.5	ZSI 2.5 Serisi Sigorta Kapağı	1610840000	4,56 TL	25
ZAP ZDL2.5	ZDL 2.5 Serisi	1720910000	8,52 TL	20
ZTW ZTL6	ZTL 6 Serisi	1771870000	13,50 TL	20
ZAP/TW ZPV1.5	ZPV 1.5 Serisi	1674650000	6,66 TL	50
ZAP/TW ZIA1.5/3L	ZIA 1.5/3L Serisi	1649540000	7,74 TL	50
ZAP/TW ZIA1.5/4L	ZIA 1.5/4L Serisi	1649550000	7,74 TL	50
ZAP/TW ZDUA	ZDUA Serisi	1720960000	3,12 TL	50
ZAP/TW ZDUA BL	ZDUA Mavi Serisi	1720970000	3,12 TL	50

Tip	A	Kutup Sayısı	Sipariş No	Fiyat/Birim	Ambalaj
Z Serisi Klemens Üst Köprü					
ZQV 1.5/2	17.5	2 Kutup / ZDU 1.5 - ZDK 1.5 - ZEI 6 Seri	1776120000	4,56 TL	60
ZQV 1.5/3	17.5	3 Kutup / ZDU 1.5 - ZDK 1.5 - ZEI 6 Seri	1776130000	9,06 TL	60
ZQV 1.5/4	17.5	4 Kutup / ZDU 1.5 - ZDK 1.5 - ZEI 6 Seri	1776140000	12,20 TL	60
ZQV 1.5/5	17.5	5 Kutup / ZDU 1.5 - ZDK 1.5 - ZEI 6 Seri	1776150000	15,35 TL	20
ZQV 1.5/10	17.5	10 Kutup / ZDU 1.5 - ZDK 1.5 - ZEI 6 Seri	1776200000	39,20 TL	20
ZQV 2.5/2	24	2 Kutup / ZDU 2.5 - ZDK 2.5 - ZTR 2.5 Seri	1608860000	4,38 TL	60

Serinin devamı sayfa 17



ZQV 2.5/4



ZQV 2.5/20



ZQV 2.5N/4 GE



ZQV 2.5N/2 GE



ZQV 2.5N/10 GE

Tip	A	Kutup Sayısı	Sipariş No	Fiyat/Birim	Ambalaj
ZQV 2.5/3	24	3 Kutup / ZDU 2.5 - ZDK 2.5 - ZTR 2.5 Seri	1608870000	7,80 TL	60
ZQV 2.5/4	24	4 Kutup / ZDU 2.5 - ZDK 2.5 - ZTR 2.5 Seri	1608880000	10,70 TL	60
ZQV 2.5/5	24	5 Kutup / ZDU 2.5 - ZDK 2.5 - ZTR 2.5 Seri	1608890000	15,35 TL	20
ZQV 2.5/6	24	6 Kutup / ZDU 2.5 - ZDK 2.5 - ZTR 2.5 Seri	1608900000	19,20 TL	20
ZQV 2.5/7	24	7 Kutup / ZDU 2.5 - ZDK 2.5 - ZTR 2.5 Seri	1608910000	22,75 TL	20
ZQV 2.5/8	24	8 Kutup / ZDU 2.5 - ZDK 2.5 - ZTR 2.5 Seri	1608920000	26,30 TL	20
ZQV 2.5/9	24	9 Kutup / ZDU 2.5 - ZDK 2.5 - ZTR 2.5 Seri	1608930000	30,10 TL	20
ZQV 2.5/10	24	10 Kutup / ZDU 2.5 - ZDK 2.5 - ZTR 2.5 Seri	1608940000	30,65 TL	20
ZQV 2.5/20	24	20 Kutup / ZDU 2.5 - ZDK 2.5 - ZTR 2.5 Seri	1908960000	71,30 TL	20
ZQV 4/2 GE	32	2 Kutup / ZDU 4 - ZDK 4/S - ZEI 6 Seri	1608950000	4,92 TL	60
ZQV 4/3 GE	32	3 Kutup / ZDU 4 - ZDK 4/S - ZEI 6 Seri	1608960000	8,52 TL	60
ZQV 4/4 GE	32	4 Kutup / ZDU 4 - ZDK 4/S - ZEI 6 Seri	1608970000	11,00 TL	60
ZQV 4/5 GE	32	5 Kutup / ZDU 4 - ZDK 4/S - ZEI 6 Seri	1608980000	16,25 TL	20
ZQV 4/6 GE	32	6 Kutup / ZDU 4 - ZDK 4/S - ZEI 6 Seri	1608990000	20,60 TL	20
ZQV 4/7 GE	32	7 Kutup / ZDU 4 - ZDK 4/S - ZEI 6 Seri	1609000000	24,40 TL	20
ZQV 4/8 GE	32	8 Kutup / ZDU 4 - ZDK 4/S - ZEI 6 Seri	1609010000	28,30 TL	20
ZQV 4/9 GE	32	9 Kutup / ZDU 4 - ZDK 4/S - ZEI 6 Seri	1609020000	32,70 TL	20
ZQV 4/10 GE	32	10 Kutup / ZDU 4 - ZDK 4/S - ZEI 6 Seri	1609030000	34,15 TL	20
ZQV 4/20 GE	32	20 Kutup / ZDU 4 - ZDK 4/S - ZEI 6 Seri	1909010000	75,70 TL	20
ZQV 6/2 GE	41	2 Kutup / ZDU 6 - ZDK 6/S - ZTL 6 Seri	1627850000	7,80 TL	60
ZQV 6/3 GE	41	3 Kutup / ZDU 6 - ZDK 6/S - ZTL 6 Seri	1627860000	14,15 TL	60
ZQV 6/4 GE	41	4 Kutup / ZDU 6 - ZDK 6/S - ZTL 6 Seri	1627870000	22,75 TL	60
ZQV 6/24 GE	41	24 Kutup / ZDU 6 - ZDK 6/S - ZTL 6 Seri	1908990000	104,05 TL	10
ZQV 10/2	57	2 Kutup / ZDU 10 Seri	1739680000	14,15 TL	25
ZQV 16/2	76	2 Kutup / ZDU 16 - ZPE 16 Seri	1739690000	14,75 TL	25
ZQV 35/2	125	2 Kutup / ZDU 35 - ZPE 35 Seri	1739700000	19,20 TL	10
ZQV 2.5N/2 GE	24	2 Kutup	1693800000	4,92 TL	60
ZQV 2.5N/3 GE	24	3 Kutup	1693810000	8,52 TL	60
ZQV 2.5N/4 GE	24	4 Kutup	1693820000	12,20 TL	60
ZQV 2.5N/5 GE	24	5 Kutup	1693830000	15,10 TL	20
ZQV 2.5N/6 GE	24	6 Kutup	1693840000	19,10 TL	20
ZQV 2.5N/7 GE	24	7 Kutup	1693850000	22,75 TL	20
ZQV 2.5N/8 GE	24	8 Kutup	1693860000	26,45 TL	20
ZQV 2.5N/9 GE	24	9 Kutup	1693870000	30,10 TL	20
ZQV 2.5N/10 GE	24	10 Kutup	1693880000	34,15 TL	20
ZVQ 2.5/1.5	24	ZDK 2,5 ve ZDLD için iki kat arası köprü	1720700000	8,52 TL	50

Klippon Connect PUSH IN Klemens Serisi

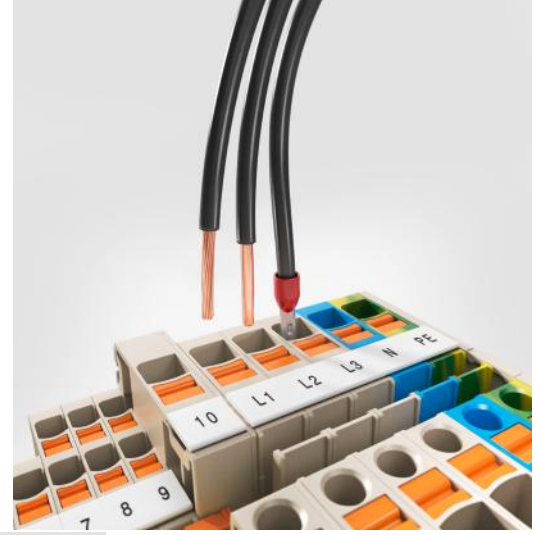
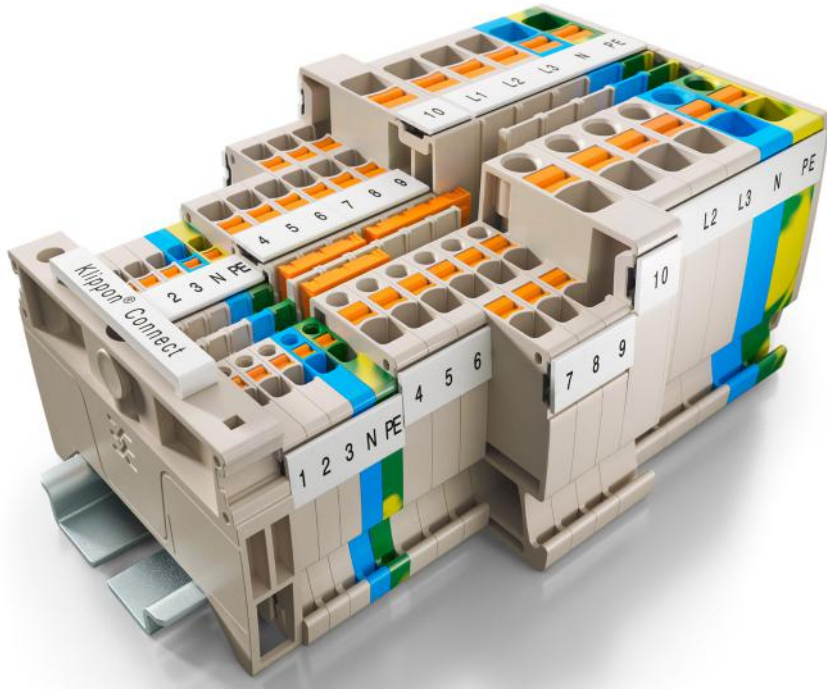

Klippon Connect PUSH-IN Klemens Serisi

Klippon® Connect'in size tüm pano yapım aşamalarında sunabileceği avantajları keşfedin.

Özel tasarlanmış işlevsel modüller ve PUSH IN teknolojisi sadece daha kısa planlama ve kurulum süreleri sağlamakla kalmaz, aynı zamanda Weidmüller Configurator ile sizlere dijital pano planlaması için gerekli ideal yazılım arayüzünü de sunar. Ayrıca entegre test noktası gibi ürün özellikleri, işletim sırasında verimliliği artırmaya somut bir şekilde yardımcı olur.

Size olağanüstü avantajlar sunabilmek için ürünlerimizi en küçük ayrıntılarına kadar titizlikle tasarladık. Bu nedenle A-Serisi Klippon® Connect klemens bloklarımız benzerlerinden bir dizi önemli noktada ayrılarak öne çıkıyor. Yepyeni bir kazanımı ayrıntılı olarak inceleyin ve geniş kullanım avantajlarını keşfedin.



- Push-in bağlantı teknolojisi
- Kurulum için harcanan zamandan %50'ye varan oranda tasarruf
- Basit modifikasyon ve uzatma
- Daha hızlı bakım çalışması

PUSH IN teknolojisine sahip üniversal klemens bloklarımız kullanıcılarına üretim sürelerini minimize ederek maksimum kazanç sağlar. Sistem modifikasyonları veya genişlemeler gibi yeniden kablolama gerektiren durumlarda el aleti kullanmaksızın montaj imkanı sunar. Push-in bağlantı teknolojisinin sunduğu yaylı tutunma sistemi sayesinde vibrasyonlara karşı stabil bir yapı oluşturulur ve maksimum ölçüde bağlantı güvenliği sağlanmış olur.



Klippon Connect PUSH IN Klemens Serisi



A2C 2.5



A2C 16



A3C 1.5



A3C 6 BL



A2T 4 BL



A3C 2.5



A2T 2.5

Tip	V / A	Kesit (Yüksüksüz)	Sipariş No	Fiyat/Birim	Ambalaj
Geçiş Klemensleri					
A2C 2.5	800/24	2.5 mm ²	1521850000	5,25 TL	100
A2C 2.5 BL	800/24	2.5 mm ²	1521880000	5,25 TL	100
A2C 1.5	500/17.5	1.5 mm ²	1552790000	7,25 TL	100
A2C 1.5 BL	500/17.5	1.5 mm ²	1552820000	7,25 TL	100
A2C 4	800/32	4 mm ²	2051180000	8,77 TL	100
A2C 4 BL	800/32	4 mm ²	2051210000	8,77 TL	100
A2C 6	800/41	6 mm ²	1992110000	12,10 TL	50
A2C 6 BL	800/41	6 mm ²	1991790000	12,10 TL	50
ALO 6	800/41	6 mm ²	1991780000	33,25 TL	20
ALO 6 BL	800/41	6 mm ²	2065120000	33,25 TL	20
A2C 10	1000/57	10 mm ²	2490360000	22,90 TL	25
A2C 10 BL	1000/57	10 mm ²	2490370000	22,90 TL	25
* A2C 16	1000/76	16 mm ²	2494000000	29,05 TL	20
* A2C 16 BL	1000/76	16 mm ²	2494100000	29,05 TL	20
* A2C 35	1000/125	35 mm ²	2551510000	49,40 TL	10
* A2C 35 BL	1000/125	35 mm ²	2552090000	49,40 TL	10

Renk Tipleri

	Bej	Mavi	Turuncu	Kahverengi	Sarı	Yeşil	Gri	Kırmızı	Siyah	Lacivert	Beyaz
--	-----	------	---------	------------	------	-------	-----	---------	-------	----------	-------

A2C 2.5	152185	152188	152193	250803	152194	152195	200311	152190	152198	250800	152197
A2C 4	205118	205121	205123	253437	205125	205126	205133	205122	205131	253438	205129
A2C 6	199211	199179	199180	-	-	-	-	-	-	-	-

Tip	V / A	Kesit (Yüksüksüz)	Sipariş No	Fiyat/Birim	Ambalaj
1 Giriş - 2 Çıkış İkilili Geçiş Klemensleri					
* A3C 1.5	500/17.5	1.5 mm ²	1552740000	9,71 TL	50
* A3C 1.5 BL	500/17.5	1.5 mm ²	1552770000	9,71 TL	50
A3C 2.5	800/24	2.5 mm ²	1521740000	10,45 TL	100
A3C 2.5 BL	800/24	2.5 mm ²	1521780000	10,45 TL	100
A3C 4	800/32	4 mm ²	2051240000	17,55 TL	50
A3C 4 BL	800/32	4 mm ²	2051280000	17,55 TL	50
A3C 6	800/41	6 mm ²	1991820000	23,50 TL	50
A3C 6 BL	800/41	6 mm ²	1991830000	23,50 TL	50
A3C 10	1000/57	10 mm ²	2490520000	36,05 TL	25
A3C 10 BL	1000/57	10 mm ²	2490510000	36,05 TL	25

2 Giriş - 2 Çıkış İkilili Geçiş Klemensleri

A4C 1.5	500/17.5	1.5 mm ²	1552690000	10,20 TL	100
A4C 1.5 BL	500/17.5	1.5 mm ²	1552700000	10,20 TL	100
A4C 2.5	800/24	2.5 mm ²	1521690000	13,80 TL	100
A4C 2.5 BL	800/24	2.5 mm ²	1521700000	13,80 TL	100
A4C 4	800/32	4 mm ²	2051500000	16,75 TL	50
A4C 4 BL	800/32	4 mm ²	2051520000	16,75 TL	50

İki Katlı Klemensler

A2T 1.5	500/17.5	1.5 mm ²	2469370000	15,05 TL	50
A2T 1.5 BL	500/17.5	1.5 mm ²	2471430000	15,05 TL	50
A2T 2.5	800/24	2.5 mm ²	1547610000	15,50 TL	50
A2T 2.5 BL	800/24	2.5 mm ²	1547620000	19,50 TL	50
* A2T 4	800/32	4 mm ²	2539970000	23,50 TL	50
* A2T 4 BL	800/32	4 mm ²	2540040000	23,50 TL	50



A2T 2.5 VL BL



A3T 2.5



AMC 2.5



A2C 2.5 PE

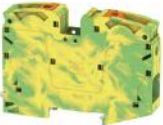

A2C 35 PE



A2T 4 PE



ADT 2.5 2C BL

Tip	V / A	Kesit (Yüksüksüz)	Sipariş No	Fiyat/Birim	Ambalaj
İki Katı Köprülü Klemensler					
A2T 1.5 VL	500/17.5	1.5 mm ²	2469400000	33,80 TL	50
A2T 1.5 VL BL	500/17.5	1.5 mm ²	2471450000	33,80 TL	50
A2T 2.5 VL	800/24	2.5 mm ²	1547650000	31,10 TL	50
* A2T 2.5 VL BL	800/24	2.5 mm ²	1547660000	31,10 TL	50
Üç Katlı Klemensler					
A3T 2.5	800/24	2.5 mm ²	2428510000	41,50 TL	50
A3T 2.5 BL	800/24	2.5 mm ²	2428520000	41,50 TL	50
A3T 2.5 VL	800/24	2.5 mm ²	2428540000	68,10 TL	25
A3T 2.5 FT-FT-PE	800/24	2.5 mm ²	2428530000	68,10 TL	50
A3T 2.5 N-FT-PE	800/24	2.5 mm ²	2428840000	68,10 TL	50
A3T 2.5 PE	800/8	2.5 mm ²	2428550000	86,15 TL	50
Dört Katlı Klemensler					
AMC 2.5	690/21	2.5 mm ²	2434340000	72,35 TL	50
AMC 2.5 800 V	800/21	2.5 mm ²	2434370000	79,85 TL	50
Topraklama Klemensleri					
A2C 1.5 PE	500/6	1.5 mm ²	1552680000	25,85 TL	50
A2C 2.5 PE	800/8	2.5 mm ²	1521680000	19,90 TL	50
A2C 4 PE	800/8	4 mm ²	2051360000	24,45 TL	50
A2C 6 PE	800/8	6 mm ²	1991810000	35,60 TL	50
A2C 10 PE	1000	10 mm ²	2490440000	49,95 TL	25
* A2C 16 PE	1000/	16 mm ²	2494010000	56,20 TL	20
* A2C 35 PE	1000/	35 mm ²	2551520000	77,60 TL	10
İki Katlı Toprak Klemensleri					
A2T 1.5 PE	500/	1.5 mm ²	2469410000	53,35 TL	50
A2T 2.5 PE	800/8	2.5 mm ²	1547680000	66,25 TL	50
* A2T 4 PE	800/	4 mm ²	2539990000	49,40 TL	50
1 Giriş - 2 Çıkış Topraklama Klemensleri					
A3C 1.5 PE	500/6	1.5 mm ²	1552670000	41,60 TL	50
A3C 2.5 PE	800/8	2.5 mm ²	1521670000	34,15 TL	50
A3C 4 PE	800/8	4 mm ²	2051410000	46,10 TL	50
A3C 6 PE	800/8	6 mm ²	1991850000	55,55 TL	50
A3C 10 PE	1000/	10 mm ²	2490590000	72,80 TL	25
A3C 16 PE	1000/	16 mm ²	2494020000	84,70 TL	20
2 Giriş - 2 Çıkış Topraklama Klemensleri					
A4C 1.5 PE	500/6	1.5 mm ²	1552660000	34,40 TL	50
A4C 2.5 PE	800/8	2.5 mm ²	1521540000	47,50 TL	50
A4C 4 PE	800/8	4 mm ²	2051560000	46,10 TL	50
Ölçme Ayırma Klemensleri					
ADT 2.5 2C	400/20	2.5 mm ² / Test Ayırma	1989800000	31,55 TL	50
* ADT 2.5 2C BL	400/20	2.5 mm ² / Test Ayırma	1989810000	31,55 TL	50
ADT 4 2C	400/20	4 mm ² / Test Ayırma	2429850000	46,25 TL	50
ADT 4 2C BL	400/20	4 mm ² / Test Ayırma	2429880000	46,25 TL	50
ADT 2.5 3C	400/20	2.5 mm ² / Test Ayırma 1 Giriş-2 Çıkış	1989830000	33,40 TL	50
ADT 2.5 4C	400/20	2.5 mm ² / Test Ayırma 2 Giriş-2 Çıkış	1989860000	38,30 TL	50
ADT 2.5 2C W/O DTLV	400/20	2.5 mm ² / Test Ayırma Sigorta Modüllü	1989930000	28,30 TL	50
ADT 2.5 3C W/O DTLV	400/20	2.5 mm ² / Test Ayırma Sigorta Modüllü 1 Giriş - 2 Çıkış	1989940000	31,90 TL	50
ADT 2.5 4C W/O DTLV	400/20	2.5 mm ² / Test Ayırma Sigorta Modüllü 2 Giriş - 2 Çıkış	1989950000	36,50 TL	50

Klippon Connect PUSH IN Klemens Serisi



AFS 2.5 CF 2C 24V BK



AFS 2.5 CF 2C BK



AEB 35 SC/1



AEP 2C 1.5



AEP 3C 1.5

Tip	V / A	Kesit (Yüksüksüz)	Sipariş No	Fiyat/Birim	Ambalaj
Sigortalı Klemensler					
AFS 2.5 CF 2C BK	500/10	2.5 mm ² / LED'siz, Oto Sigortalı	2466530000	32,55 TL	50
AFS 2.5 CF 2C 12V BK	500/10	2.5 mm ² / LED'li, Oto Sigortalı	2466610000	75,35 TL	50
* AFS 2.5 CF 2C 24V BK	500/10	2.5 mm ² / LED'li, Oto Sigortalı	2466600000	68,20 TL	50
AFS 4 2C BK	500/6.3	4 mm ² / LED'siz, 5x20 Cam Sigortalı	2429860000	50,80 TL	50
AFS 4 2C 10-36V BK	500/6.3	4 mm ² / LED'li, 5x20 Cam Sigortalı	2429870000	121,85 TL	50
AFS 4 2C 30-70V BK	500/6.3	4 mm ² / LED'li, 5x20 Cam Sigortalı	2434350000	121,85 TL	50
AFS 4 2C 60-150V BK	500/6.3	4 mm ² / LED'li, 5x20 Cam Sigortalı	2434380000	121,85 TL	50
AFS 4 2C 100-250V BK	500/6.3	4 mm ² / LED'li, 5x20 Cam Sigortalı	2434390000	121,85 TL	50

Tip	Açıklama	Sipariş No	Fiyat/Birim	Ambalaj
Durdurucular				
AEB 35 SC/1	Klemens durdurucu	1991920000	5,94 TL	50
ZEW 35/2	Vidasız Tip 8mm Kalınlık	8630740000	6,90 TL	20

Tip	Renk	Açıklama	Sipariş No	Fiyat/Birim	Ambalaj
Sonlandırma ve Ayırma Plakaları					
AEP 2C 1.5	Bej	A2C 1.5 Serisi	1552600000	4,86 TL	50
AEP 2C 1.5 BL	Mavi	A2C 1.5 Serisi	1552610000	4,86 TL	50
AEP 3C 1.5	Bej	A3C 1.5 PE Serisi	1552620000	6,00 TL	50
AEP 4C 1.5	Bej	A4C 1.5 Serisi	1552640000	4,92 TL	50
AEP 4C 1.5 BL	Mavi	A4C 1.5 Serisi	1552650000	4,92 TL	50
AEP 2C 2.5	Bej	A2C 2.5 Serisi	1514400000	4,92 TL	50
AEP 2C 2.5 BL	Mavi	A2C 2.5 Serisi	1514420000	4,92 TL	50
AEP 3C 2.5	Bej	A3C 2.5 Serisi	1521510000	4,98 TL	50
AEP 3C 2.5 BL	Mavi	A3C 2.5 Serisi	1521520000	4,98 TL	50
AEP 4C 2.5	Bej	A4C 2.5 Serisi	1521530000	5,10 TL	50
AEP 4C 2.5 BL	Mavi	A4C 2.5 Serisi	1521640000	5,10 TL	50
AEP 3C 4	Bej	A3C 4 Serisi	2051720000	7,98 TL	20
AEP 3C 4 BL	Mavi	A3C 4 Serisi	2051880000	7,98 TL	20
AEP 2C 4	Bej	A2C 4 Serisi	2051680000	5,52 TL	50
AEP 2C 4 BL	Mavi	A2C 4 Serisi	2051690000	5,52 TL	50
AEP 4C 4	Bej	A4C 4 Serisi	2051900000	7,08 TL	20
AEP 4C 4 BL	Mavi	A4C 4 Serisi	2051910000	7,08 TL	20
AEP 2C 6	Bej	A2C 6 Serisi	1991970000	7,50 TL	50
AEP 2C 6 BL	Mavi	A2C 6 Serisi	1991950000	7,50 TL	50
AEP 3C 6	Bej	A3C 6 Serisi	1991940000	7,80 TL	50
AEP 3C 6 BL	Mavi	A3C 6 Serisi	1991910000	7,80 TL	20
AEP 2C 10/16		A2C 10/16 Serisi	2490380000	8,88 TL	20
AEP 2C 10/16 BL		A2C 10/16 Serisi	2490390000	8,88 TL	20
AEP 3C 10/16		A3C 10/16 Serisi	2490530000	9,36 TL	20
AEP 3C 10/16 BL		A3C 10/16 Serisi	2490540000	9,36 TL	20
AEP 2T 2.5	Bej	A2T 2.5 Serisi	1547690000	5,46 TL	20
AEP 2T 2.5 BL	Mavi	A2T 2.5 Serisi	1547700000	5,46 TL	20
AEP 3T 2.5	Bej	A3T 2.5 Serisi	2428560000	9,06 TL	20
AEP 3T 2.5 BL	Mavi	A3T 2.5 Serisi	2428860000	9,06 TL	20
AEP MC 2.5	Bej	AMC 2.5 Serisi	2433820000	9,06 TL	25
AEP DT 2.5 3C	Bej	ADT 2.5 3CW/O DTLV	1989970000	5,46 TL	50
AEP DT 2.5 4C	Bej	ADT 2.5 4C Serisi	1989980000	5,52 TL	50
AEP 4C 2.5 BK	Siyah	AFS 2.5 CF 2C Serisi	2486660000	6,66 TL	50
AEP 3C 4 BK	Siyah	AFS 4 2C Serisi	2486640000	8,28 TL	20

Tip	Kutup	Açıklama	Sipariş No	Fiyat/Birim	Ambalaj
Üst Köprüler					
ZQV 1.5N/2	2-pole	ZQV 1.5N	1985410000	4,86 TL	60
ZQV 1.5N/3	3-pole	ZQV 1.5N	1985480000	8,52 TL	60
ZQV 1.5N/4	4-pole	ZQV 1.5N	1985490000	12,65 TL	60
ZQV 1.5N/5	5-pole	ZQV 1.5N	1985500000	16,70 TL	20
ZQV 1.5N/6	6-pole	ZQV 1.5N	1985510000	21,30 TL	20
ZQV 1.5N/7	7-pole	ZQV 1.5N	1985520000	25,70 TL	20
ZQV 1.5N/8	8-pole	ZQV 1.5N	1985540000	30,05 TL	20
ZQV 1.5N/9	9-pole	ZQV 1.5N	1985560000	34,20 TL	20
ZQV 1.5N/10 OR	10-pole	ZQV 1.5N	1985580000	37,55 TL	20
ZQV 1.5N/10 BL	10-pole	ZQV 1.5N	1985680000	37,55 TL	20
ZQV 1.5N/10 RD	10-pole	ZQV 1.5N	1985800000	37,55 TL	20
ZQV 1.5N/20	20-pole	ZQV 1.5N	1985600000	71,50 TL	20
ZQV 1.5N/50	50-pole	ZQV 1.5N	1985620000	196,00 TL	5
ZQV 2.5N/2	2-pole	ZQV 2.5N	1527540000	4,86 TL	60
ZQV 2.5N/3	3-pole	ZQV 2.5N	1527570000	8,52 TL	60
ZQV 2.5N/4	4-pole	ZQV 2.5N	1527590000	12,65 TL	60
ZQV 2.5N/5	5-pole	ZQV 2.5N	1527620000	16,70 TL	20
ZQV 2.5N/6	6-pole	ZQV 2.5N	1527630000	21,30 TL	20
ZQV 2.5N/7	7-pole	ZQV 2.5N	1527640000	25,70 TL	20
ZQV 2.5N/8	8-pole	ZQV 2.5N	1527670000	30,05 TL	20
ZQV 2.5N/9	9-pole	ZQV 2.5N	1527680000	34,20 TL	20
ZQV 2.5N/10	10-pole	ZQV 2.5N	1527690000	37,55 TL	20
ZQV 2.5N/20	20-pole	ZQV 2.5N	1527720000	71,50 TL	20
ZQV 2.5N/50	50-pole	ZQV 2.5N	1527730000	196,00 TL	5
ZQV 4N/2	2-pole	ZQV 4N	1527930000	4,98 TL	60
ZQV 4N/3	3-pole	ZQV 4N	1527940000	9,12 TL	60
ZQV 4N/4	4-pole	ZQV 4N	1527970000	13,60 TL	60
ZQV 4N/5	5-pole	ZQV 4N	1527980000	17,90 TL	60
ZQV 4N/6	6-pole	ZQV 4N	1527990000	22,25 TL	20
ZQV 4N/7	7-pole	ZQV 4N	1528020000	26,45 TL	20
ZQV 4N/8	8-pole	ZQV 4N	1528030000	30,85 TL	20
ZQV 4N/9	9-pole	ZQV 4N	1528070000	34,90 TL	20
ZQV 4N/10	10-pole	ZQV 4N	1528090000	40,15 TL	20
ZQV 4N/50	50-pole	ZQV 4N	1528130000	229,10 TL	5
ZQV 6N/2	2-pole	ZQV 6N	1985740000	6,00 TL	60
ZQV 6N/3	3-pole	ZQV 6N	1985760000	12,10 TL	60
ZQV 6N/4	4-pole	ZQV 6N	1985780000	17,90 TL	60



ZQV 1.5N/2



ZQV 1.5N/4



ZQV 2.5N/50



ZQV 4N/4

PUSH - IN & Yay Bağlantılı Soketli Klemens Çözümleri

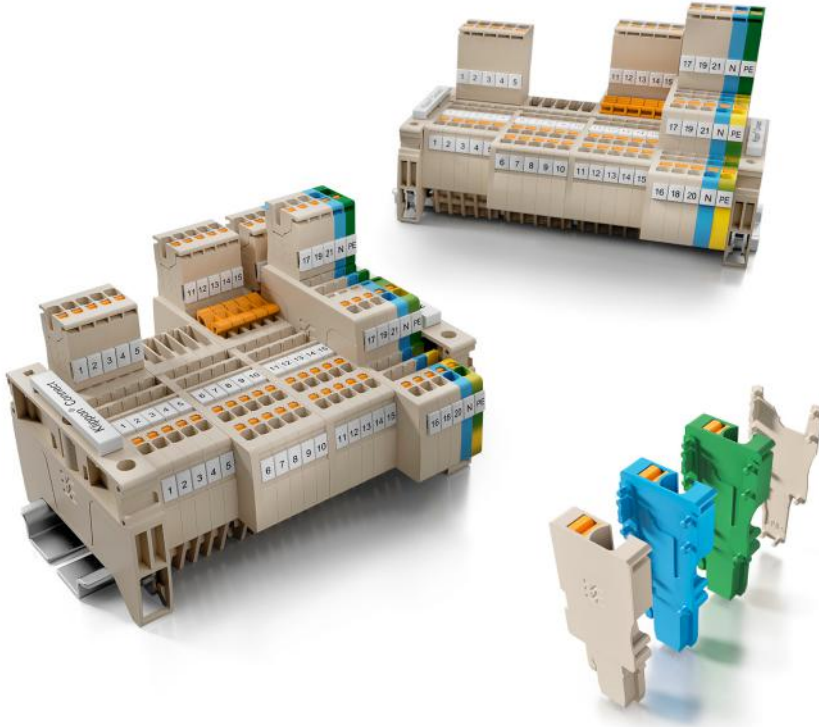

APGTB 2.5 FT 2C/1



APGTB 2.5 FT 3C/1

Tip	V / A	Kesit (Yüksüksüz)	Sipariş No	Fiyat/Birim	Ambalaj
Push-in Bağlantılı Soketli Klemensler / Geçiş Taban Modül					
APGTB 1.5 FT 2C/1	500/17.5	1.5 mm ²	2482160000	8,88 TL	50
APGTB 1.5 FT 2C/1 BL	500/17.5	1.5 mm ²	2482170000	8,88 TL	50
APGTB 1.5 FT 3C/1	500/17.5	1.5 mm ²	2482180000	11,00 TL	50
APGTB 1.5 FT 3C/1 BL	500/17.5	1.5 mm ²	2482190000	11,00 TL	50
APGTB 1.5 FT 4C/2	500/17.5	1.5 mm ²	2482200000	12,35 TL	50
APGTB 1.5 FT 4C/2 BL	500/17.5	1.5 mm ²	2482210000	12,35 TL	50
APGTB 1.5 2T 4C/2	500/17.5	1.5 mm ²	2485840000	17,20 TL	50
APGTB 1.5 2T 4C/2 BL	500/17.5	1.5 mm ²	2485850000	17,20 TL	50
APGTB 1.5 2T VL 4C/2	500/17.5	1.5 mm ²	2485920000	38,65 TL	50
APGTB 1.5 2T VL 4C/2 BL	500/17.5	1.5 mm ²	2485930000	38,65 TL	50
APGTB 2.5 FT 2C/1	800/24	2.5 mm ²	1513970000	9,60 TL	100
APGTB 2.5 FT 2C/1 BL	800/24	2.5 mm ²	1513990000	10,15 TL	100
APGTB 2.5 FT 3C/1	800/24	2.5 mm ²	1514000000	14,90 TL	50
APGTB 2.5 FT 3C/1 BL	800/24	2.5 mm ²	1514020000	12,65 TL	50
APGTB 2.5 FT 4C/2	800/24	2.5 mm ²	1514030000	19,75 TL	50
APGTB 2.5 FT 4C/2 BL	800/24	2.5 mm ²	1514040000	16,55 TL	50
APGTB 2.5 2T 4C/2	800/24	2.5 mm ²	1548060000	17,80 TL	50
APGTB 2.5 2T 4C/2 BL	800/24	2.5 mm ²	1548070000	25,10 TL	50
APGTB 2.5 2T VL 4C/2	800/24	2.5 mm ²	1548140000	47,75 TL	50
APGTB 2.5 2T VL 4C/2 BL	800/24	2.5 mm ²	1548150000	50,30 TL	50
APG 2.5/3-BG-BL-GN	800/24	2.5 mm ²	1513820000	29,60 TL	25

Tip	V / A	Kesit (Yüksüksüz)	Sipariş No	Fiyat/Birim	Ambalaj
Push-in Bağlantılı Soketli Klemensler / Toprak Taban Modül					
APGTB 1.5 PE 2C/1	500/	1.5 mm ²	2482220000	31,15 TL	50
APGTB 1.5 PE 3C/1	500/	1.5 mm ²	2482230000	38,70 TL	50
APGTB 1.5 PE 4C/2	500/	1.5 mm ²	2482240000	41,45 TL	50
APGTB 1.5 2T FT-PE 4C/2	500/17.5	1.5 mm ²	2485860000	39,60 TL	50
APGTB 1.5 2T PE 4C/2	500/	1.5 mm ²	2485870000	61,15 TL	50
APGTB 2.5 PE 2C/1	800/24	2.5 mm ²	1513870000	32,10 TL	50
APGTB 2.5 PE 3C/1	800	2.5 mm ²	1513890000	48,35 TL	50
APGTB 2.5 PE 4C/2	800/	2.5 mm ²	1513920000	50,20 TL	50
APGTB 2.5 2T FT-PE 4C/2	800/24	2.5 mm ²	1548130000	42,65 TL	50
APGTB 2.5 2T PE 4C/2	800/24	2.5 mm ²	1548160000	63,25 TL	50
Soket Grup Aksesuarları					
MCV APG 1.5	APG 1,5 Serisi		2485980000	4,92 TL	50
AEP PGTB 1.5 4C/2	PGTB 1.5 4C/2 Serisi		2482510000	5,46 TL	50
AEP PGTB 1.5 4C/2 BL	PGTB 1.5 4C/2 BL Serisi		2482520000	5,46 TL	50
APG 1.5 L	500/17.5	1.5 mm ²	2482250000	11,00 TL	50
APG 1.5 L BL	500/17.5	1.5 mm ²	2482260000	11,00 TL	50
APG 1.5 L GN	500/17.5	1.5 mm ²	2482270000	11,00 TL	50
APG 1.5 MI	500/17.5	1.5 mm ²	2482280000	11,00 TL	50
APG 1.5 MI BL	500/17.5	1.5 mm ²	2482290000	11,00 TL	50
APG 1.5 MI GN	500/17.5	1.5 mm ²	2482300000	11,00 TL	50
APG 1.5 R	500/17.5	1.5 mm ²	2482310000	11,00 TL	50
APG 1.5 R BL	500/17.5	1.5 mm ²	2482320000	11,00 TL	50
APG 1.5 R GN	500/17.5	1.5 mm ²	2482330000	11,00 TL	50
APG 1.5/1	500/17.5	1.5 mm ²	2482340000	11,00 TL	50
APG 1.5/2	500/17.5	1.5 mm ²	2482350000	18,50 TL	25
APG 1.5/3	500/17.5	1.5 mm ²	2482360000	25,90 TL	25
APG 1.5/3-BG-BL-GN	500/17.5	1.5 mm ²	2482460000	29,60 TL	25
APG 1.5/4	500/17.5	1.5 mm ²	2482370000	33,40 TL	25
APG 1.5/4-3BG-GN	500/17.5	1.5 mm ²	2482450000	37,50 TL	25
APG 1.5/5	500/17.5	1.5 mm ²	2482380000	40,85 TL	25
APG 1.5/5-3BG-BL-GN	500/17.5	1.5 mm ²	2482440000	45,00 TL	25
APG 1.5/6	500/17.5	1.5 mm ²	2482390000	48,35 TL	25
APG 1.5/7	500/17.5	1.5 mm ²	2482400000	55,90 TL	25
APG 1.5/8	500/17.5	1.5 mm ²	2482410000	63,25 TL	20
APG 1.5/9	500/17.5	1.5 mm ²	2482420000	70,75 TL	20
APG 1.5/10	500/17.5	1.5 mm ²	2482430000	78,25 TL	20
MCV APG 2.5	500/17.5	1.5 mm ²	2035590000	5,64 TL	50
AEP PGTB 2.5 4C/2	500/17.5	1.5 mm ²	1514450000	5,64 TL	50
AEP PGTB 2.5 4C/2 BL	500/17.5	1.5 mm ²	1514470000	5,64 TL	50
APG 2.5 L	500/17.5	2.5 mm ²	1513830000	12,10 TL	50
APG 2.5 L BL	500/17.5	2.5 mm ²	1513840000	12,10 TL	50
APG 2.5 L GN	500/17.5	2.5 mm ²	1513850000	12,10 TL	50
APG 2.5 MI	500/17.5	2.5 mm ²	1513880000	12,10 TL	50
APG 2.5 MI BL	500/17.5	2.5 mm ²	1513900000	12,10 TL	50
APG 2.5 MI GN	500/17.5	2.5 mm ²	1513930000	12,10 TL	50
APG 2.5 R	500/17.5	2.5 mm ²	1513940000	12,10 TL	50
APG 2.5 R BL	500/17.5	2.5 mm ²	1513950000	12,10 TL	50
APG 2.5 R GN	500/17.5	2.5 mm ²	1513980000	12,10 TL	50
APG 2.5/1	1 pin	2.5 mm ²	1513720000	11,50 TL	50



MCV APG 2.5



APG 2.5 L



APG 2.5/1

Serinin devamı sayfa 26

Soketli Klemens Çözümleri



APG 2.5/3



ZT 2.5/2AN/1



ZTPE 2.5/2AN/1



ZTPE 2.5/4AN/2



ZDT 2.5/2



ZP 2.5/1AN/1

Tip	V / A	Kesit (Yüksüksüz)	Sipariş No	Fiyat/Birim	Ambalaj
APG 2.5/2	2 pin	2.5 mm ²	1513640000	17,40 TL	25
APG 2.5/3	3 pin	2.5 mm ²	1513650000	23,75 TL	25
APG 2.5/3-BG-BL-GN	3 pin	2.5 mm ²	1513820000	29,60 TL	25
APG 2.5/4	4 pin	2.5 mm ²	1513670000	33,95 TL	25
APG 2.5/4-3BG-GN	4 pin	2.5 mm ²	1513790000	44,45 TL	25
APG 2.5/5	5 pin	2.5 mm ²	1513680000	41,50 TL	25
APG 2.5/5-3BG-BL-GN	5 pin	2.5 mm ²	1513780000	51,85 TL	25
APG 2.5/6	6 pin	2.5 mm ²	1513690000	49,30 TL	25
APG 2.5/7	7 pin	2.5 mm ²	1513700000	56,50 TL	25
APG 2.5/8	8 pin	2.5 mm ²	1513730000	64,25 TL	20
APG 2.5/9	9 pin	2.5 mm ²	1513740000	72,00 TL	20
APG 2.5/10	10 pin	2.5 mm ²	1513770000	79,60 TL	20

Yay Bağlantılı Soketli Klemensler / Geçiş Taban Modül

ZT 2.5/2AN/1	500 / 24	0.5 - 4 mm ² / 1 Yay - 1 Soket Bağlantı	1815070000	12,65 TL	50
ZT 2.5/3AN/1	500 / 24	0.5 - 4 mm ² / 2 Yay - 1 Soket Bağlantı	1815090000	17,95 TL	50
ZT 2.5/4AN/2	500 / 24	0.5 - 4 mm ² / 2 Yay - 2 Soket Bağlantı	1815110000	21,25 TL	50
ZT 2.5/4AN/4	500 / 24	0.5 - 4 mm ² / 4 Soket Bağlantı	1815130000	17,95 TL	50
ZT 4/2AN/1	800 / 32	0.5 - 6 mm ² / 1 Yay - 1 Soket Bağlantı	1854960000	18,90 TL	50
ZT 4/4AN/2	800 / 32	0.5 - 6 mm ² / 2 Yay - 2 Soket Bağlantı	1848350000	30,85 TL	50

Yay Bağlantılı Soketli Klemensler / Toprak Taban Modül

ZTPE 2.5/2AN/1	500	0.5 - 4 mm ² / 1 Yay - 1 Soket Bağlantı	1815080000	23,40 TL	50
ZTPE 2.5/3AN/1	500	0.5 - 4 mm ² / 2 Yay - 1 Soket Bağlantı	1815100000	30,85 TL	50
ZTPE 2.5/4AN/2	500	0.5 - 4 mm ² / 2 Yay - 2 Soket Bağlantı	1815120000	32,70 TL	50
ZTPE 2.5/4AN/4	500	0.5 - 4 mm ² / 4 Soket Bağlantı	1815140000	30,85 TL	50
ZTPE 4/2AN/1	800	0.5 - 6 mm ² / 1 Yay - 1 Soket Bağlantı	1854970000	32,70 TL	50
ZTPE 4/4AN/2	800	0.5 - 6 mm ² / 2 Yay - 2 Soket Bağlantı	1848330000	53,35 TL	50

Yay Bağlantılı Soketli Klemensler / İki Katlı ve Ayrırma Taban Modül

ZDT 2.5/2	500 / 24	0.5 - 4 mm ² / Her Kat 1 Yay - 1 Soket Bağlantı	1815150000	30,85 TL	50
ZDT 2.5/2 DU-PE	500 / 24	0.5 - 4 mm ² / Her Kat 1 Yay - 1 Soket Bağlantı / Alt Toprak	1815160000	46,90 TL	50
ZTTR 2.5	400 / 16	0.5 - 4 mm ² / 2 Yay - 1 Soket Bağlantı / Ayrırma	1865510000	29,50 TL	50
ZTTR 2.5 0.TNHE	400 / 16	0.5 - 4 mm ² / 2 Yay - 1 Soket Bağlantı / SIHA - BEST	1905470000	27,65 TL	50

Yay Bağlantılı Soketli Klemensler / Soketler

ZP 2.5/1AN/1	500 / 24	0.5 - 4 mm ² / 1 Kutup	1815430000	14,35 TL	50
ZP 2.5/1AN/2	500 / 24	0.5 - 4 mm ² / 2 Kutup	1815440000	25,10 TL	25
ZP 2.5/1AN/3	500 / 24	0.5 - 4 mm ² / 3 Kutup	1815450000	36,55 TL	25
ZP 2.5/1AN/4	500 / 24	0.5 - 4 mm ² / 4 Kutup	1815500000	46,90 TL	25
ZP 2.5/1AN/5	500 / 24	0.5 - 4 mm ² / 5 Kutup	1815510000	48,25 TL	25
ZP 2.5/1AN/6	500 / 24	0.5 - 4 mm ² / 6 Kutup	1815520000	52,70 TL	25
ZP 2.5/1AN/7	500 / 24	0.5 - 4 mm ² / 7 Kutup	1815530000	60,95 TL	25
ZP 2.5/1AN/8	500 / 24	0.5 - 4 mm ² / 8 Kutup	1815540000	68,70 TL	20
ZP 2.5/1AN/9	500 / 24	0.5 - 4 mm ² / 9 Kutup	1815550000	77,15 TL	20
ZP 2.5/1AN/10	500 / 24	0.5 - 4 mm ² / 10 Kutup	1815560000	108,55 TL	20
ZP 2.5/1AN/11	500 / 24	0.5 - 4 mm ² / 11 Kutup	1815570000	111,10 TL	20
ZP 2.5/1AN/12	500 / 24	0.5 - 4 mm ² / 12 Kutup	1815580000	111,80 TL	20
ZP 2.5/1AN/13	500 / 24	0.5 - 4 mm ² / 13 Kutup	1815590000	113,05 TL	10
ZP 2.5/1AN/14	500 / 24	0.5 - 4 mm ² / 14 Kutup	1815600000	118,80 TL	10
ZP 2.5/1AN/15	500 / 24	0.5 - 4 mm ² / 15 Kutup	1815610000	127,20 TL	10
ZP 2.5/1AN/16	500 / 24	0.5 - 4 mm ² / 16 Kutup	1815620000	135,55 TL	10
ZP 2.5/1AN/17	500 / 24	0.5 - 4 mm ² / 17 Kutup	1815180000	146,40 TL	10

Serinin devamı sayfa 27

Tip	V / A	Kesit (Yüksüksüz)	Sipariş No	Fiyat/Birim	Ambalaj
ZP 2.5/1AN/QV/1	500 / 24	0.5 - 4 mm ² / 1 Kutup / Köprülenebilir	1815190000	15,35 TL	50
ZP 2.5/1AN/QV/2	500 / 24	0.5 - 4 mm ² / 2 Kutup / Köprülenebilir	1815200000	27,65 TL	25
ZP 2.5/1AN/QV/3	500 / 24	0.5 - 4 mm ² / 3 Kutup / Köprülenebilir	1815210000	36,55 TL	25
ZP 2.5/1AN/QV/4	500 / 24	0.5 - 4 mm ² / 4 Kutup / Köprülenebilir	1815220000	48,80 TL	25
ZP 2.5/1AN/QV/10	500 / 24	0.5 - 4 mm ² / 10 Kutup / Köprülenebilir	1815280000	108,55 TL	20
ZP 4/1AN/1	800 / 32	0.5 - 6 mm ² / 1 Kutup	1848340000	25,45 TL	50
ZP 4/1AN/2	800 / 32	0.5 - 6 mm ² / 2 Kutup	1854990000	43,00 TL	25
ZP 4/1AN/3	800 / 32	0.5 - 6 mm ² / 3 Kutup	1855000000	57,10 TL	25
ZP 4/1AN/4	800 / 32	0.5 - 6 mm ² / 4 Kutup	1855010000	74,45 TL	25
ZP 4/1AN/10	800 / 32	0.5 - 6 mm ² / 10 Kutup	1855070000	190,75 TL	10

Tip	Açıklama	Sipariş No	Fiyat/Birim	Ambalaj
Yalı Bağlantı Nihayet Plakaları				
ZAP/TW ZT2.5/2AN	ZT 2.5/2AN Serisi	1816030000	4,38 TL	50
ZAP/TW ZT2.5/3AN	ZT 2.5/3AN Serisi	1816050000	4,38 TL	50
ZAP/TW ZT2.5/4AN/2	ZT 2.5/4AN/2 Serisi	1816070000	5,76 TL	50
ZAP/TW ZT2.5/4AN/4	ZT 2.5/4AN/4 Serisi	1816090000	5,76 TL	50

Güç ve Sinyal Dağıtım Çözümleri



AAP Serisi PUSH -IN Dağıtım Blokları



Marshalling, Güç Dağıtım Klemensleri



WPD Güç Dağıtım Klemensi

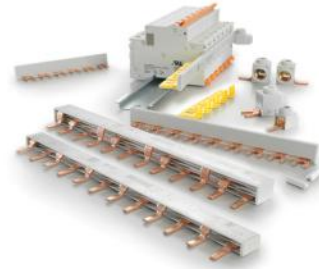

Güç Dağıtım Baraları



SET AAP11 6/1.5/12C



AAP11 6/6X1.5 LO-LI BL



AAP11 6 LO RD



AAP11 6 LO OR

Tip	Açıklama	Çıkış	Sipariş No	Fiyat/Birim	Ambalaj
-----	----------	-------	------------	-------------	---------

AAP Serisi PUSH - IN Dağıtım Blokları

Faz Nötr Ayrı Hazır Bloklar

* SET AAP11 6/1.5/12C	Faz ve Nötr Girişleri 6 mm ²	12xFaz ve 12xNötr (1.5mm ²)	2506090000	152,90 TL	1
* SET AAP11 6/1.5/24C	Faz ve Nötr Girişleri 6 mm ²	24xFaz ve 24xNötr (1.5mm ²)	2506370000	244,60 TL	1
* SET AAP12 10/2.5/10C	Faz ve Nötr Girişleri 10 mm ²	10xFaz ve 10xNötr (2.5mm ²)	2506350000	206,95 TL	1

*Farklı konfigürasyonlar için ürünler tek tek kombinlenebilir.

Faz Nötr Aynı Sırada Hazır Bloklar

* SET AAP13 6/1.5/12C	Faz ve Nötr Girişleri 6 mm ²	12xFaz ve 12xNötr (1.5mm ²)	2506340000	194,05 TL	1
* SET AAP13 6/1.5/24C	Faz ve Nötr Girişleri 6 mm ²	24xFaz ve 24xNötr (1.5mm ²)	2506380000	341,05 TL	1
* SET AAP14 10/2.5/10C	Faz ve Nötr Girişleri 10 mm ²	10xFaz ve 10xNötr (2.5mm ²)	2506360000	199,90 TL	1

*Farklı konfigürasyonlar için ürünler tek tek kombinlenebilir.

6x1.5 mm² Yan kapaksız Hazır Bloklar

* AAP11 6/6X1.5 LO-LI BL	6 mm ² Girişli Bej (Kırmızı Butonlu)	6x1.5 mm ²	2464750000	41,15 TL	20
* AAP11 6/6X1.5 LO-LI RD	6 mm ² Girişli Bej (Mavi Butonlu)	6x1.5 mm ²	2464690000	41,15 TL	20
* AAP11 6/6X1.5 PE-LI	Sarı-Yeşil 6 mm ² (Topraklama)	6x1.5 mm ²	2464740000	52,90 TL	20
* AAP11 6/6X1.5 LO-LI BL/OR	Mavi 6 mm ² Girişli	6x1.5 mm ²	2522830000	41,15 TL	20

*Yan kapak olarak 1988320000 kullanılacaktır.

Tip	V / A	Kesit (Yüksüksüz)	Sipariş No	Fiyat/Birim	Ambalaj
-----	-------	-------------------	------------	-------------	---------

AAP Serisi PUSH - IN Dağıtım Blokları

Potansiyel Dağıtım Blokları için Besleme Modülleri

AAP11 6 LO RD	500/41	6 mm ²	1989780000	24,60 TL	20
AAP11 6 LO BL/OR	500/41	6 mm ²	2522720000	25,90 TL	20
AAP11 6 LO BL	500/41	6 mm ²	1988130000	24,60 TL	20
AAP11 6 LO OR	500/41	6 mm ²	2503650000	25,90 TL	20

Serinin devamı sayfa 29



AAP11 1.5 LI RD



AEP AP11



AIO21 1.5 SI



AEP IO21



PRV 4 SW 35X15 RT



PRV 8 SW 35X15 RT/WS

Tip	V / A	Kesit (Yüksüksüz)	Sipariş No	Fiyat/Birim	Ambalaj
AAP13 6 LO-LO	250/41	6 mm ²	1988260000	43,05 TL	20
AAP12 10 LO RD	800/57	10 mm ²	1988190000	55,40 TL	20
AAP12 10 LO BL	800/57	10 mm ²	1988180000	55,40 TL	20
AAP12 10 LO BL/OR	800/57	10 mm ²	2522860000	58,30 TL	20
AAP12 10 LO OR	800/57	10 mm ²	2503900000	58,30 TL	20
AAP14 10 LO-LO	500/57	10 mm ²	1988250000	73,85 TL	20

*Farklı renklerdeki seçimler için lütfen bizimle iletişime geçebilirsiniz.

Potansiyel Dağıtım Klemensleri

AAP11 1.5 LI RD	500/17.5	1.5 mm ²	1988160000	27,05 TL	50
AAP11 1.5 LI BL	500/17.5	1.5 mm ²	1988170000	27,05 TL	50
AAP11 1.5 LI BL/OR	500/17.5	1.5 mm ²	2522870000	28,50 TL	50
AAP11 1.5 LI OR	500/17.5	1.5 mm ²	2503910000	28,50 TL	50
AAP13 1.5 LI-LI	250/17.5	1.5 mm ²	1988280000	30,80 TL	50
AAP12 2.5 LI RD	800/24	2.5 mm ²	1988290000	30,80 TL	50
AAP12 2.5 LI BL	800/24	2.5 mm ²	1988100000	30,80 TL	50
AAP12 2.5 LI BL/OR	800/24	2.5 mm ²	2522840000	32,40 TL	50
AAP12 2.5 LI OR	800/24	2.5 mm ²	2503880000	32,40 TL	50
AAP14 2.5 LI-LI	500/24	2.5 mm ²	1988230000	30,80 TL	50

*Farklı renklerdeki seçimler için lütfen bizimle iletişime geçebilirsiniz.

Potansiyel Dağıtım Klemensleri Sonlandırma Plakaları

AEP AP11	APP11		1988320000	7,08 TL	20
AEP AP12	APP12		1988300000	7,08 TL	20
AEP AP13	APP13		1990140000	8,52 TL	20
AEP AP14	APP14		1988340000	8,52 TL	20

Sensör Bağlantı Klemensleri

AIO21 1.5 SI	250/13.5	1.5 mm ²	1992260000	29,50 TL	100
AIO21 1.5 SO	250/13.5	1.5 mm ²	1992240000	27,55 TL	100
AIO21 1.5 SO-PE	250/13.5	1.5 mm ²	1992250000	50,05 TL	100
AIO22 1.5 SI-PE	250/13.5	1.5 mm ²	1992230000	52,85 TL	100
AIO23 1.5 2SI	250/13.5	1.5 mm ²	1992220000	56,20 TL	100

Sensör Bağlantı Klemensleri Yan Kapakları

AEP IO21	AIO21		1993580000	7,08 TL	50
AEP IO22	AIO22		1993590000	7,08 TL	50
AEP IO23	AIO23		1993600000	8,52 TL	50

Marshalling, Güç Dağıtım Klemensleri ve Aksesuarları

Marshalling Geçiş Klemensleri

PRV 4 SW 35X15 RT	250 / 10	0.2 - 1.5 mm ² / TS35x15 / Dört Kat / 16 Bağlantı	1173810000	109,85 TL	20
PRV 4 BL 35X15 RT	250 / 10	0.2 - 1.5 mm ² / TS35x15 / Dört Kat / 16 Bağlantı	1267890000	109,85 TL	20
PRV 4 SW 35X7.5 RT	250 / 10	0.2 - 1.5 mm ² / TS35x7.5 / Dört Kat / 16 Bağlantı	1173830000	109,85 TL	20
PRV 4 BL 35X7.5 RT	250 / 10	0.2 - 1.5 mm ² / TS35x7.5 / Dört Kat / 16 Bağlantı	1267900000	109,85 TL	20
PRV 4 SW 35X15 WS	250 / 10	0.2 - 1.5 mm ² / TS35x15 / Dört Kat / 16 Bağlantı	1173820000	109,85 TL	20
PRV 4 BL 35X15 WS	250 / 10	0.2 - 1.5 mm ² / TS35x15 / Dört Kat / 16 Bağlantı	1173920000	109,85 TL	20
PRV 4 SW 35X7.5 WS	250 / 10	0.2 - 1.5 mm ² / TS35x7.5 / Dört Kat / 16 Bağlantı	1173840000	109,85 TL	20
PRV 4 BL 35X7.5 WS	250 / 10	0.2 - 1.5 mm ² / TS35x7.5 / Dört Kat / 16 Bağlantı	1173930000	109,85 TL	20
PRV 8 SW 35X15 RT/WS	250 / 8	0.2 - 1.5 mm ² / TS35x15 / Sekiz Kat / 32 Bağlantı	1173740000	211,90 TL	20
PRV 8 BL 35X15 RT/WS	250 / 8	0.2 - 1.5 mm ² / TS35x15 / Sekiz Kat / 32 Bağlantı	1267830000	211,90 TL	20
PRV 8 SW 35X7.5 RT/WS	250 / 8	0.2 - 1.5 mm ² / TS35x7.5 / Sekiz Kat / 32 Bağlantı	1173790000	211,90 TL	20
PRV 8 BL 35X7.5 RT/WS	250 / 8	0.2 - 1.5 mm ² / TS35x7.5 / Sekiz Kat / 32 Bağlantı	1267840000	211,90 TL	20
PRV 8 SW 35X15 WS/RT	250 / 8	0.2 - 1.5 mm ² / TS35x15 / Sekiz Kat / 32 Bağlantı	1173780000	211,90 TL	20

Serinin devamı sayfa 30



PRV 16 SW 35X15 RT/WS

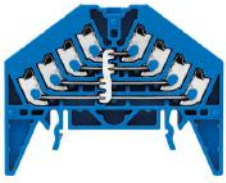

PPV 4 BL 35X15 DGR



PAP PRV/PPV4 SW

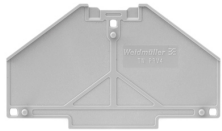

TW PRV4 1-4

Tip	V / A	Kesit (Yüksüksüz)	Sipariş No	Fiyat/Birim	Ambalaj
PRV 8 BL 35X15 WS/RT	250 / 8	0.2 - 1.5 mm ² / TS35x15 / Sekiz Kat / 32 Bağlantı	1173900000	211,90 TL	20
PRV 8 SW 35X7.5 WS/RT	250 / 8	0.2 - 1.5 mm ² / TS35x7.5 / Sekiz Kat / 32 Bağlantı	1173800000	211,90 TL	20
PRV 8 BL 35X7.5 WS/RT	250 / 8	0.2 - 1.5 mm ² / TS35x7.5 / Sekiz Kat / 32 Bağlantı	1173910000	211,90 TL	20
PRV 16 SW 35X15 RT/WS	250 / 6	0.2 - 1.5 mm ² / TS35x15 / Onaltı Kat / 64 Bağlantı	1173620000	462,50 TL	20
PRV 16 BL 35X15 RT/WS	250 / 6	0.2 - 1.5 mm ² / TS35x15 / Onaltı Kat / 64 Bağlantı	1267790000	462,50 TL	20
PRV 16 SW 35X7.5 RT/WS	250 / 6	0.2 - 1.5 mm ² / TS35x7.5 / Onaltı Kat / 64 Bağlantı	1173680000	462,50 TL	20
PRV 16 BL 35X7.5 RT/WS	250 / 6	0.2 - 1.5 mm ² / TS35x7.5 / Onaltı Kat / 64 Bağlantı	1267810000	462,50 TL	20
PRV 16 SW 35X15 WS/RT	250 / 6	0.2 - 1.5 mm ² / TS35x15 / Onaltı Kat / 64 Bağlantı	1173650000	462,50 TL	20
PRV 16 BL 35X15 WS/RT	250 / 6	0.2 - 1.5 mm ² / TS35x15 / Onaltı Kat / 64 Bağlantı	1267800000	462,50 TL	20
PRV 16 SW 35X7.5 WS/RT	250 / 6	0.2 - 1.5 mm ² / TS35x7.5 / Onaltı Kat / 64 Bağlantı	1173710000	462,50 TL	20
PRV 16 BL 35X7.5 WS/RT	250 / 6	0.2 - 1.5 mm ² / TS35x7.5 / Onaltı Kat / 64 Bağlantı	1267820000	462,50 TL	20

Güç Dağıtım Klemensleri - Eş Potansiyel Bara Tip

PPV 4 BL 35X15 DGR	250 / 17.5	0.2 - 1.5 mm ² / TS35x15 / Dört Kat / 16 Bağlantı	1267910000	117,60 TL	20
PPV 4 GR 35X15 DGR	250 / 17.5	0.2 - 1.5 mm ² / TS35x15 / Dört Kat / 16 Bağlantı	1173880000	117,60 TL	20
PPV 4 BL 35X7.5 DGR	250 / 17.5	0.2 - 1.5 mm ² / TS35x7.5 / Dört Kat / 16 Bağlantı	1267920000	117,60 TL	20
PPV 4 GR 35X7.5 DGR	250 / 17.5	0.2 - 1.5 mm ² / TS35x7.5 / Dört Kat / 16 Bağlantı	1173890000	120,80 TL	20
PPV 8 BL 35X15 DGR	250 / 17.5	0.2 - 1.5 mm ² / TS35x15 / Sekiz Kat / 32 Bağlantı	1267870000	227,40 TL	20
PPV 8 GR 35X15 DGR	250 / 17.5	0.2 - 1.5 mm ² / TS35x15 / Sekiz Kat / 32 Bağlantı	1173850000	227,40 TL	20
PPV 8 BL 35X7.5 DGR	250 / 17.5	0.2 - 1.5 mm ² / TS35x7.5 / Sekiz Kat / 32 Bağlantı	1267880000	227,40 TL	20
PPV 8 GR 35X7.5 DGR	250 / 17.5	0.2 - 1.5 mm ² / TS35x7.5 / Sekiz Kat / 32 Bağlantı	1173870000	227,40 TL	20

Tip	Açıklama	Sipariş No	Fiyat/Birim	Ambalaj
-----	----------	------------	-------------	---------

Marshalling, Güç Dağıtım Klemensleri ve Aksesuarları

Nihayet Plakaları

PAP PRV/PPV4 SW	PRV4 ve PPV4 Serisi - Siyah	1173750000	6,48 TL	10
PAP PRV/PPV4 GR	PRV4 ve PPV4 Serisi - Gri	1211450000	6,48 TL	10
PAP PRV/PPV8 SW	PRV8 ve PPV8 Serisi - Siyah	1173720000	9,84 TL	10
PAP PRV/PPV8 GR	PRV8 ve PPV8 Serisi - Siyah	1211460000	9,84 TL	10

Ayrırma Plakaları

TW PRV4	Baskısız	1173700000	8,04 TL	10
TW PRV4 0-3	0...3 Baskı	1230060000	20,15 TL	10
TW PRV4 1-4	1...4 Baskı	1230050000	20,15 TL	10
TW PRV4 A-D	A...D Baskı	1230070000	20,15 TL	10
TW PRV8	Baskısız	1173670000	12,90 TL	10
TW PRV8 0-7	0...7 Baskı	1230090000	20,60 TL	10
TW PRV8 1-8	1...8 Baskı	1230080000	20,60 TL	10
TW PRV8 A-H	A...H Baskı	1230110000	20,60 TL	10
TW PRV16	Baskısız	1173630000	31,90 TL	10
TW PRV16 0-15	0...15 Baskı	1230130000	39,85 TL	10
TW PRV16 1-16	1...16 Baskı	1230120000	39,85 TL	10
TW PRV16 A-P	A...P Baskı	1230140000	39,85 TL	10



WPD 130 1X50/1X50 BN



WPD 132 1X185/1X185 BN

WPD 104
1x25+1x16/2x16+3x10 GY

Tip	Kablo Kesiti / Nominal Gerilim	Nominal Akım	Sipariş No	Fiyat/Birim	Ambalaj
WPD Güç Dağıtım Klemensi					
WPD 130 1X50/1X50 GY	50mm ² / 1000 V	120 A	2502530000	85,50 TL	9
WPD 130 1X50/1X50 BL	50mm ² / 1000 V	120 A	2502540000	85,50 TL	9
WPD 130 1X50/1X50 GN	50mm ² / 1000 V	120 A	2502550000	85,50 TL	9
WPD 130 1X50/1X50 BN	50mm ² / 1000 V	120 A	2502560000	85,50 TL	9
WPD 130 1X50/1X50 BK	50mm ² / 1000 V	120 A	2502570000	85,50 TL	9
WPD 230 2X50/2X50 GY	50mm ² / 1000 V	120 A	2502580000	157,90 TL	5
WPD 230 2X50/2X50 BL	50mm ² / 1000 V	120 A	2502590000	157,90 TL	5
WPD 230 2X50/2X50 GN	50mm ² / 1000 V	120 A	2502600000	157,90 TL	5
WPD 230 2X50/2X50 BN	50mm ² / 1000 V	120 A	2502610000	157,90 TL	5
WPD 230 2X50/2X50 BK	50mm ² / 1000 V	120 A	2502950000	157,90 TL	5
WPD 330 3X50/3X50 3XGY	50mm ² / 1000 V	120 A	2502620000	244,90 TL	3
WPD 330 3X50/3X50 1XGY/1XBL/1XGN	50mm ² / 1000 V	120 A	2502640000	244,90 TL	3
WPD 330 3X50/3X50 1XBN/1XBK/1XGY	50mm ² / 1000 V	120 A	2502650000	244,90 TL	3
WPD 131 1X95/1X95 BL	95mm ² / 1000 V	155 A	2502660000	162,25 TL	2
WPD 131 1X95/1X95 GN	95mm ² / 1000 V	155 A	2502670000	162,25 TL	2
WPD 131 1X95/1X95 BN	95mm ² / 1000 V	155 A	2502680000	162,25 TL	2
WPD 131 1X95/1X95 BK	95mm ² / 1000 V	155 A	2502690000	162,25 TL	2
WPD 131 1X95/1X95 GY	95mm ² / 1000 V	155 A	2503090000	162,25 TL	2
WPD 231 2X95/2X95 GY	95mm ² / 1000 V	155 A	2502700000	317,45 TL	1
WPD 231 2X95/2X95 BL	95mm ² / 1000 V	155 A	2502710000	317,45 TL	1
WPD 231 2X95/2X95 GN	95mm ² / 1000 V	155 A	2502720000	317,45 TL	1
WPD 231 2X95/2X95 BN	95mm ² / 1000 V	155 A	2502730000	317,45 TL	1
WPD 231 2X95/2X95 BK	95mm ² / 1000 V	155 A	2502740000	317,45 TL	1
WPD 132 1X185/1X185 GY	185 mm ² / 1000 V	250 A	2502750000	332,00 TL	1
WPD 132 1X185/1X185 BL	185 mm ² / 1000 V	250 A	2502760000	332,00 TL	1
WPD 132 1X185/1X185 GN	185 mm ² / 1000 V	250 A	2502770000	332,00 TL	1
WPD 132 1X185/1X185 BN	185 mm ² / 1000 V	250 A	2502780000	332,00 TL	1
WPD 132 1X185/1X185 BK	185 mm ² / 1000 V	250 A	2502790000	332,00 TL	1
WPD 232 2X185/2X185 GY	185 mm ² / 1000 V	250 A	2502800000	652,00 TL	1
WPD 232 2X185/2X185 BL	185 mm ² / 1000 V	250 A	2502810000	652,00 TL	1
WPD 232 2X185/2X185 GN	185 mm ² / 1000 V	250 A	2502820000	652,00 TL	1
WPD 232 2X185/2X185 BN	185 mm ² / 1000 V	250 A	2502830000	652,00 TL	1
WPD 232 2X185/2X185 BK	185 mm ² / 1000 V	250 A	2502840000	652,00 TL	1
WPD 133 1X300/1X300 GY	300 mm ² / 1000 V	340 A	2502850000	810,00 TL	1
WPD 133 1X300/1X300 BL	300 mm ² / 1000 V	340 A	2502860000	810,00 TL	1
WPD 133 1X300/1X300 GN	300 mm ² / 1000 V	340 A	2502870000	810,00 TL	1
WPD 133 1X300/1X300 BN	300 mm ² / 1000 V	340 A	2502880000	810,00 TL	1
WPD 133 1X300/1X300 BK	300 mm ² / 1000 V	340 A	2502890000	810,00 TL	1
WPD 233 2X300/2X300 GY	300 mm ² / 1000 V	340 A	2502900000	1.608,00 TL	1
WPD 233 2X300/2X300 BL	300 mm ² / 1000 V	340 A	2502910000	1.608,00 TL	1
WPD 233 2X300/2X300 GN	300 mm ² / 1000 V	340 A	2502920000	1.608,00 TL	1
WPD 233 2X300/2X300 BN	300 mm ² / 1000 V	340 A	2502930000	1.608,00 TL	1
WPD 233 2X300/2X300 BK	300 mm ² / 1000 V	340 A	2502940000	1.608,00 TL	1
WPD Potansiyel Dağıtım Blokları					
Tip	Kesit Aralığı Input / Output	Çalışma Gerilimi	Sipariş No	Fiyat/Birim	Ambalaj
WPD 104 1x25+1x16/2x16+3x10 BL	25 mm ² / 16 mm ²	1000 V AC/DC	2518250000	295,90 TL	1
WPD 104 1x25+1x16/2x16+3x10 GY	25 mm ² / 16 mm ²	1000 V AC/DC	1562000000	288,50 TL	1
WPD 204 2X25/4X16+6X10 2XBL	25 mm ² / 16 mm ²	1000 V AC/DC	2518330000	549,00 TL	1
WPD 204 2X25/4X16+6X10 2XGY	25 mm ² / 16 mm ²	1000 V AC/DC	1562150000	535,00 TL	1
WPD 304 3X25/6X16+9X10 3XBL	25 mm ² / 16 mm ²	1000 V AC/DC	2518340000	1.054,00 TL	1
WPD 304 3X25/6X16+9X10 3XGY	25 mm ² / 16 mm ²	1000 V AC/DC	1562160000	1.028,00 TL	1

Serinin devamı sayfa 32

Tip	Kesit Aralığı Input / Output	Çalışma Gerilimi	Sipariş No	Fiyat/Birim	Ambalaj
WPD 105 1x35+1x16/2x25+3x16 BL	35 mm ² / 25 mm ²	1000 V AC/DC	2518540000	490,40 TL	1
WPD 105 1x35+1x16/2x25+3x16 GY	35 mm ² / 25 mm ²	1000 V AC/DC	1562170000	476,95 TL	1
WPD 205 2X35/4X25+6X16 2XBL	35 mm ² / 25 mm ²	1000 V AC/DC	2519470000	965,00 TL	1
WPD 205 2X35/4X25+6X16 2XGY	35 mm ² / 25 mm ²	1000 V AC/DC	1562180000	942,00 TL	1
WPD 305 3X35/6X25+9X16 3XGY	35 mm ² / 25 mm ²	1000 V AC/DC	1562190000	1.390,00 TL	1
WPD 106 1X70/2X25+3X16 BL	70 mm ² / 25 mm ²	1000 V AC/DC	2518570000	593,00 TL	1
WPD 106 1X70/2X25+3X16 GY	70 mm ² / 25 mm ²	1000 V AC/DC	1562210000	579,00 TL	1
WPD 107 1X95/2X35+8X25 BL	95 mm ² / 25 mm ²	1000 V AC/DC	2521730000	742,00 TL	1
WPD 107 1X95/2X35+8X25 GY	95 mm ² / 25 mm ²	1000 V AC/DC	1562220000	724,00 TL	1
WPD 108 1X120/2X35+3X25+4X16 BL	120 mm ² / 35 mm ²	1000 V AC / 1500 V DC	2519480000	960,00 TL	1
WPD 108 1X120/2X35+3X25+4X16 GY	120 mm ² / 35 mm ²	1000 V AC / 1500 V DC	1562100000	937,00 TL	1
WPD 109 1X185/2X35+3X25+4X16 BL	185 mm ² / 35 mm ²	1000 V AC / 1500 V DC	2519490000	982,00 TL	1
WPD 109 1X185/2X35+3X25+4X16 GY	185 mm ² / 35 mm ²	1000 V AC / 1500 V DC	1562090000	955,00 TL	1

Tip	Kutup Sayısı	Modül Sayısı	Sipariş No	Fiyat/Birim	Ambalaj
Motor Koruma Şalter Barası (16mm² - 80A)					
* G-1L-160/16	1P	9	2657800000	16,00 TL	10
* G-1L-210/16	1P	12	2657820000	20,55 TL	10
* G-1L-268/16	1P	15	2657840000	26,60 TL	10
* G-1L-320/16	1P	18	2657860000	32,00 TL	10
* G-2L-210/16 C	2P	12	2658120000	39,25 TL	5
* G-2L-320/16 C	2P	18	2658140000	61,00 TL	5
* G-3L-160/16 C	3P	9	2658360000	41,70 TL	5
* G-3L-210/16 C	3P	12	2658380000	53,45 TL	5
* G-3L-268/16 C	3P	15	2658400000	71,90 TL	5
* G-3L-320/16 C	3P	18	2658420000	86,40 TL	5
* G-3L-375/16 C	3P	21	2658440000	100,90 TL	20
* G-4L-210/16 C	4P	12	2658720000	86,10 TL	5
* G-4L-285/16 C	4P	16	2658740000	110,25 TL	5

Tip	Kutup Sayısı	Modül Sayısı	Sipariş No	Fiyat/Birim	Ambalaj
Otomatik Sigorta Besleme Barası (16mm² - 80A)					
* S-1L-160/16	1P	9	2657960000	16,00 TL	10
* S-1L-210/16	1P	12	2657980000	20,55 TL	10
* S-1L-268/16	1P	15	2658000000	26,60 TL	10
* S-1L-320/16	1P	18	2658020000	32,00 TL	10
* S-2L-210/16	2P	12	2658240000	39,25 TL	5
* S-2L-320/16	2P	18	2658260000	61,00 TL	5
* S-3L-160/16	3P	9	2658540000	45,00 TL	5
* S-3L-210/16	3P	12	2658560000	53,45 TL	5
* S-3L-268/16	3P	15	2658580000	71,90 TL	5
* S-3L-320/16	3P	18	2658600000	86,40 TL	5
* S-3L-375/16	3P	21	2658620000	110,00 TL	5
* S-4L-210/16	4P	12	2658860000	86,10 TL	5
* S-4L-285/16	4P	16	2658880000	110,25 TL	5

Tip	Açıklama	Sipariş No	Fiyat/Birim	Ambalaj
Bara Aksesuarları				
* END CAP G+S 1L/10-16	1 kutup bara sonlandırma aparatı	2658970000	2,75 TL	50
* END CAP G+S 2L/16	2 kutup bara sonlandırma aparatı	2658990000	3,29 TL	10
* END CAP G+S 3L/16	3 kutup bara sonlandırma aparatı	2659600000	4,00 TL	10
* END CAP G+S 4L/16	4 kutup bara sonlandırma aparatı	2659030000	4,39 TL	10
* PROTECTION COVER G+S /5	Uyarı markalaması	2659040000	17,95 TL	10
* FIT 25 GN	Motor koruma uzatma aparatı	2659050000	27,45 TL	10
* FIT 25 SN	Otomatik Sigorta uzatma aparatı	2659060000	27,45 TL	10

Not: Baralarımızda, bara sonlandırma aparatı kullanımı zorunludur.

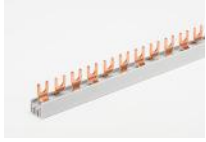

G-3L-210/16 C



S-4L-210/16



END CAP G+S 3L/16



FIT 25 GN

Markalama Sistemleri

Dekafix Klemens Markalama

Çeşitli konnektörler için her türlü markalama isteklerini pratik, hızlı, düzenli ve mükemmel bir görsellikte çözer. Dekafix - kullanıma hazır olan markalama her türlü klemens ve elektronik ekipmana uygundur.

Grup Etiketleri

Grup etiket taşıyıcıları direkt ray üzerine tutturulabildikleri gibi, klemens üzerinde kullanılabilen çeşitleri de mevcuttur. SCHAT 5 ve SCHAT 5S doğrudan DIN ray üzerine tutturulur. Etiketler şeffaf bir koruyucu ile dış etkenlerden izole edilir.

Kablo Etiketleri SlimFix ve SlimFix Clip

SlimFix (SF) kablo etiketleri kablo montajı yapıldıktan sonra takılabilir. Halogenfree malzemeden üretilmiş olup V0/V2 yanmazlık normuna uygun olarak tasarlanmıştır. SF Tool yardımı ile hızlı ve kolayca monte edilebilir. Weidmüller, çok çeşitli markalama imkanları ve baskı teknolojilerini kullanımınıza sunar.

PrintJet Advanced

Renkli baskı teknolojisi ve silinmez baskı özelliği ile alanında eşsiz olan bu cihaz mürekkep püskürtme tekniği ile çalışır. Bu şekilde bireysel yazı şekilleri ve logolar oluşturulabilir.

Mürekkep püskürtmeli renkli baskı tekniği

- Kolay kullanım
- Grafik baskı imkanı
- Dayanıklı yazı ile kazıma yerine kullanılabilme
- Etiketleri baskı sonrası hemen kullanılabilme
- Tüm windows temelindeki programların desteklenmesi
- Tüm multikartlara baskı yapılabilmesi
- Metal Markalama

Hazır Baskılı Kablo Etiketleri CableLine ®

Hazır baskılı kablo etiketler CableLine ® ile 0.5 mm² ile 70mm² arası iletkenler kolay bir şekilde markalanabilir. Kapalı tip ve açık tipleri de mevcuttur. Kablo bağı ile bağlanan renkli versiyonları ayrıca üretilmektedir.

WKM Kablo Markalama

Büyük kesitte kablolar için kablo bağı ile iletkene tutturulan bu tip, ağır sanayi şartlarına uygundur.

- 3 farklı boyut için
- Baskılı etiketler için şeffaf kapak ile koruma
- Tüm kesitler için kablo bağı ile montaj





DEK 5 FW 1-50



DEK 6 FW 1-50



DEK 8 FWZ 1-10

Tip	Baskı	Ölçü	Sipariş No	Fiyat/Birim	Ambalaj
Dekafix					
DEK 5					
DEK 5 FW 1-50	Baskı 1 - 50	5,0 mm	0473460001	0,650 TL	500
DEK 5 FW 51-100	Baskı 51 - 100	5,0 mm	0473460051	0,650 TL	500
DEK 5 FW 101-150	Baskı 101 - 150	5,0 mm	0473460101	0,650 TL	500
DEK 5 FW 151-200	Baskı 151 - 200	5,0 mm	0473460151	0,650 TL	500
DEK 5 FW 201-250	Baskı 201 - 250	5,0 mm	0473460201	0,650 TL	500
DEK 5 FWZ 1-10	Baskı 1 - 10	5,0 mm	0523060001	0,650 TL	500
DEK 5 FWZ 11-20	Baskı 11 - 20	5,0 mm	0523060011	0,650 TL	500
DEK 5 FWZ 21-30	Baskı 21 - 30	5,0 mm	0523060021	0,650 TL	500
DEK 5 FWZ 31-40	Baskı 31 - 40	5,0 mm	0523060031	0,650 TL	500
DEK 5 FWZ 41-50	Baskı 41 - 50	5,0 mm	0523060041	0,650 TL	500
DEK 5 FWZ 51-60	Baskı 51 - 60	5,0 mm	0523060051	0,650 TL	500
DEK 5 FWZ 61-70	Baskı 61 - 70	5,0 mm	0523060061	0,650 TL	500
DEK 5 FWZ 71-80	Baskı 71 - 80	5,0 mm	0523060071	0,650 TL	500
DEK 5 FWZ 81-90	Baskı 81 - 90	5,0 mm	0523060081	0,650 TL	500
DEK 5 FWZ 91-100	Baskı 91 - 100	5,0 mm	0523060091	0,650 TL	500
DEK 5 GW +	Baskı +	5,0 mm	0576261198	0,650 TL	500
DEK 5 GW -	Baskı -	5,0 mm	0576261199	0,650 TL	500
DEK 5 GW ERDE	Baskı Toprak	5,0 mm	0576261202	0,650 TL	500
DEK 5 GW ERDE I.KR.	Baskı Toprak Yuvarlak İçinde	5,0 mm	0576261203	0,650 TL	500
DEK 5 GW L1	Baskı L1	5,0 mm	0522361075	0,650 TL	500
DEK 5 GW L2	Baskı L2	5,0 mm	0522361076	0,650 TL	500
DEK 5 GW L3	Baskı L3	5,0 mm	0522361077	0,650 TL	500
DEK 5 FWZ L1-PE	Baskı L1 - PE	5,0 mm	0354361187	0,650 TL	500
DEK 6					
DEK 6 FW 1-50	Baskı 1 - 50	6,0 mm	0468660001	0,650 TL	500
DEK 6 FW 51-100	Baskı 51 - 100	6,0 mm	0468660051	0,650 TL	500
DEK 6 FW 101-150	Baskı 101 - 150	6,0 mm	0468660101	0,650 TL	500
DEK 6 FW 151-200	Baskı 151 - 200	6,0 mm	0468660151	0,650 TL	500
DEK 6 FW 201-250	Baskı 201 - 250	6,0 mm	0468660201	0,650 TL	500
DEK 6 FWZ 1-10	Baskı 1 - 10	6,0 mm	0518960001	0,650 TL	500
DEK 6 FWZ 11-20	Baskı 11 - 20	6,0 mm	0518960011	0,650 TL	500
DEK 6 FWZ 21-30	Baskı 21 - 30	6,0 mm	0518960021	0,650 TL	500
DEK 6 FWZ 31-40	Baskı 31 - 40	6,0 mm	0518960031	0,650 TL	500
DEK 6 FWZ 41-50	Baskı 41 - 50	6,0 mm	0518960041	0,650 TL	500
DEK 6 FWZ 51-60	Baskı 51 - 60	6,0 mm	0518960051	0,650 TL	500
DEK 6 FWZ 61-70	Baskı 61 - 70	6,0 mm	0518960061	0,650 TL	500
DEK 6 FWZ 71-80	Baskı 71 - 80	6,0 mm	0518960071	0,650 TL	500
DEK 6 FWZ 81-90	Baskı 81 - 90	6,0 mm	0518960081	0,650 TL	500
DEK 6 FWZ 91-100	Baskı 91 - 100	6,0 mm	0518960091	0,650 TL	500
DEK 6 GW +	Baskı +	6,0 mm	1318061198	0,650 TL	500
DEK 6 GW -	Baskı -	6,0 mm	1318061199	0,650 TL	500
DEK 6 GW ERDE	Baskı Toprak	6,0 mm	1318061202	0,650 TL	500
DEK 6 FWZ L1-PE	Baskı L1 - PE	6,0 mm	0631961187	0,650 TL	500
DEK 6 FWZ L1-ERDE I.KRE	Baskı L1	6,0 mm	0631961203	0,650 TL	500
DEK 8					
DEK 8 FWZ 1-10	Baskı 1 - 10	8,0 mm	1276960001	0,690 TL	500
DEK 8 FWZ 11-20	Baskı 11 - 20	8,0 mm	1276960011	0,690 TL	500
DEK 8 FWZ 21-30	Baskı 21 - 30	8,0 mm	1276960021	0,690 TL	500
DEK 8 FWZ 31-40	Baskı 31 - 40	8,0 mm	1276960031	0,690 TL	500
DEK 8 FWZ 41-50	Baskı 41 - 50	8,0 mm	1276960041	0,690 TL	500

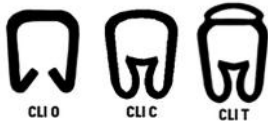

PRINTJET ADVANCED 230V



MCP BASIC 2



THM MULTIMARK



DEK 5/5 MC NE WS

Tip	Açıklama	Kesit	Sipariş No	Fiyat/Birim	Ambalaj
CLI C - Kapalı - Açık Tip Kablo Markalama					
CLI C Kapalı Tip - PVC, V0 (UL 94), Lazer baskı					
CLI C 02/3	Baskılı	0.20 - 1.50 mm	025211xxxx	0,341 TL	1000
CLI C 02-3 GE NE MP	Baskısız	0.20 - 1.50 mm	0213811687	0,341 TL	200
CLI C 01/3	Baskılı	1.50 - 4.00 mm	025261xxxx	0,341 TL	1000
CLI C 1-3 GE NE MP	Baskısız	1.50 - 4.00 mm	0171111687	0,341 TL	200

Tip	Açıklama	Sipariş No	Fiyat/Birim	Ambalaj
Kablo Markalama Cihazları				
PRINTJET ADVANCED 230V	Inkjet Yazıcı	1324380000	5.700,00 €	1
MCP BASIC 2	A4 Plotter	2438520000	4.400,00 €	1
* THM MULTIMARK	Multimark yüzeyleri için termal transfer yazıcı	2599430000	2.200,00 €	1

Cihaz Aksesuarları				
PJ PRO TINTENSET FARBE	PrintJet Pro Renkli Set	1027110000	600,00 €	1
PJ PRO TNTK INK K	PrintJet Pro Siyah mürekkep	1027040000	133,00 €	1
PJ PRO TNTK INK C	PrintJet Pro Mavi mürekkep	1027050000	133,00 €	1
PJ PRO TNTK INK M	PrintJet Pro Kırmızı mürekkep	1027060000	133,00 €	1
PJ PRO TNTK INK Y	PrintJet Pro Sarı mürekkep	1027070000	133,00 €	1
PJ PRO TNAW	PrintJet Pro Atık mürekkep tankı	1024140000	280,00 €	1
PJ ADV TNTK INK SET	PrintJet Advanced Renkli Set	1338720000	570,00 €	1
PJ ADV TNTK INK K	PrintJet Advanced Siyah mürekkep	1338690000	155,00 €	1
PJ ADV TNTK INK C	PrintJet Advanced Mavi mürekkep	1338680000	155,00 €	1
PJ ADV TNTK INK M	PrintJet Advanced Kırmızı mürekkep	1338670000	155,00 €	1
PJ ADV TNTK INK Y	PrintJet Advanced Sarı mürekkep	1338650000	155,00 €	1
PJ ADV TNAW	PrintJet Advanced Atık mürekkep tankı	1338710000	262,00 €	1
MCP AP BASIC	Multikart taşıyıcı - Plotter için	1139880000	636,00 €	1
RIBBON MM 80/360 SW	THM MM ile uyumlu, Siyah renk, 80 cm genişlik, 360 m uzunluk	2005080000	140,00 €	1
RIBBON MM 110/360 SW	THM MM ile uyumlu, Siyah renk, 110 cm genişlik, 360 m uzunluk	2005070000	150,00 €	1
RIBBON MM 80/300 WS	THM MM ile uyumlu, Beyaz Renk, 80 cm genişlik, 360 m uzunluk	2005040000	420,00 €	1
RIBBON MM-TB 25/360 SW	THM MM ile uyumlu, Siyah Renk, 25 cm genişlik, 360 m uzunluk	2005090000	40,00 €	1
THM MMP CUTTER	Markalama kesme aparatı	1331600000	1.000,00 €	1
RIBBON THM HIRE	Termal yazıcı için ribon	1790650000	256,00 €	1
RIBBON HSS HF EL 40/300	Termal yazıcı için ribon 40/300 Daralan makaron için	1426210000	154,00 €	1
THM MMP EXT.RH	30 mt. Makoron İçin Taşıyıcı	1302920000	380,00 €	1
ADAPTER ALU STI-S	STI-S Kalem için	1762440000	48,00 €	1
STI Waterproof schwarz	Silinmez Kalem	0508401694	13,53 €	10

Tip	Ölçü	Sipariş No	Fiyat/Birim	Ambalaj
Klemens Etiketleri - Multikart				
DEK 5/5 MC NE WS	5 / 5 mm	1609801044	0,612 TL	1000
DEK 5/5 PLUS MC NE WS	5 / 5 mm	1854490000	0,612 TL	1000
DEK 5/5 S MC NE WS	5 / 5 mm	1341620000	0,726 TL	400
DEK 5/6 MC NE WS	5 / 6 mm	1609820000	0,613 TL	1000
DEK 5/6.5 MC NE WS	5 / 6,5 mm	1609840000	0,613 TL	900
DEK 5/7.5 MC NE WS	5 / 7,5 mm	1720620000	0,928 TL	320
DEK 5/8 MC NE WS	5 / 8 mm	1856740000	0,626 TL	800
WS 8/5 MC NE WS	8 / 5 mm	1640740000	1,06 TL	720
WS 8/5 PLUS MC NE WS	8 / 5 mm	1951870000	1,08 TL	600
WS 10/5 MC NE WS	10 / 5 mm	1635000000	1,06 TL	720
WS 12/5 MC NE WS	12 / 5 mm	1609860000	1,06 TL	720
WS 10/6 MC NE WS	10 / 6 mm	1828450000	1,06 TL	600
WS 12/6 MC NE WS	12 / 6 mm	1609900000	1,06 TL	600

Serinin devamı sayfa 36



MF 5/5 MC NE WS

Tip	Ölçü	Sipariş No	Fiyat/Birim	Ambalaj
WS 10/8 PLUS MC NE WS	10 / 8 mm	1905950000	1,09 TL	420
WS 12/8 PLUS MC NE WS	12 / 8 mm	1906000000	1,09 TL	420
WS 10/12 MC NE WS	10 / 12 mm	1905970000	1,09 TL	300
WS 10/15 MC NE WS	10 / 15 mm	1854090000	1,22 TL	240
ZS 10/5 MC NE WS	10 / 5 mm	1610000000	1,39 TL	480
ZS 15/5 MC NE WS	15 / 5 mm	1646630000	1,39 TL	480

Klemens Etiketleri - Diğer Marka Klemensler için Multifit

MF 5/5 MC NE WS	5 / 5 mm	1816250000	0,950 TL	500
MF-W 5/5 MINI MC NE WS	5 / 5 mm	1816240000	0,950 TL	500
MF 8/5 MC NE WS	8 / 5 mm	1677140000	1,20 TL	600
MF 10/5 MC NE WS	10 / 5mm	1677160000	1,20 TL	600
MF 12/5 MC NE WS	12 / 5 mm	1677180000	1,20 TL	600
MF 5/6 MC NE WS	5 / 6 mm	1816260000	0,950 TL	500
MF-W 9/6 MC NE WS	9 / 6 mm	1816290000	1,20 TL	500
MF 10/6 MC NE WS	10 / 6 mm	1677220000	1,20 TL	600



SCHT 5 S

Tip	Açıklama	En / Boy	Sipariş No	Fiyat/Birim	Ambalaj
Klemens Grup Markalama TS 32 ve TS 35					
SCHT 5	Klemens grup markalama	19,5 / 44,5 mm	0292460000	14,88 TL	20
SCHT 5 S	Klemens grup markalama	9,5 / 44,5 mm	1631930000	16,80 TL	20
EM 8/30	Şeffaf, klemens üzerine kaplayan	8 / mm30 mm	1806120000	11,10 TL	50

Tip	Açıklama	En / Renk	Sipariş No	Fiyat/Birim	Ambalaj
Klemens Grup Markalama TS 32 ve TS 35					
ESO 5 DIN A4 WS	SCHT 5 - A4 Kağıt Yazdırma Yüzeyi	60 / Beyaz	1607710000	28,20 TL	10
ESO 5 S DIN A4 WS	SCHT 5 S - A4 Kağıt Yazdırma Yüzeyi	60 / Beyaz	1631920000	28,20 TL	10
ESO 5 P DIN A4 WS	SCHT 5 - A4 Kağıt Yazdırma Yüzeyi	60 / Beyaz	1670370000	303,00 TL	10
ESO 5 P DIN A4 GE	SCHT 5 - A4 Kağıt Yazdırma Yüzeyi	60 / Sarı	1670380000	303,00 TL	10
ESO 5 DIN A4 GE	SCHT 5 - A4 Kağıt Yazdırma Yüzeyi	140 / Sarı	1631350000	28,20 TL	10



WAD 5 MC NE WS

Tip	Renk	Ölçü / Adet	Sipariş No	Fiyat/Birim	Ambalaj
WAD Multikard Klemens Grup Etiketleri					
WAD 5 MC NE WS	Beyaz	5 mm / 12 adet	1112910000	2,82 TL	48
WAD 5 MC NE GE	Sarı	5 mm / 12 adet	1112920000	2,82 TL	48
WAD 8 MC NE WS	Beyaz	8 mm / 12 adet	1112940000	4,30 TL	48
WAD 8 MC NE GE	Sarı	8 mm / 12 adet	1112950000	4,30 TL	48
WAD 5 MC B GE/SW	Sarı "Enerji" İşareti baskılı 5 mm	5 mm / 12 adet	1120450000	5,10 TL	48
WAD 8 MC B GE/SW	Sarı "Enerji" İşareti baskılı 8 mm	8 mm / 12 adet	1120470000	5,10 TL	48



SFC 0/12 MC NE WS

Tip	Renk	Kablo Kesit	Sipariş No	Fiyat/Birim	Ambalaj
SlimFix Clip - Çıtırklı Kablo Markalama					
12 mm Uzunluk					
SFC 0/12 MC NE WS	Beyaz / neutral	0,5 - 1,0 mm ²	1813130000	1,49 TL	200
SFC 0/12 MC NE GE	Sarı / neutral	0,5 - 1,0 mm ²	1813160000	1,49 TL	200
SFC 1/12 MC NE WS	Beyaz / neutral	0,75 - 2,5 mm ²	1747320001	1,49 TL	200
SFC 1/12 MC NE GE	Sarı / neutral	0,75 - 2,5 mm ²	1747320004	1,49 TL	200
SFC 2/12 MC NE WS	Beyaz / neutral	2,5 - 4,0 mm ²	1758320001	1,66 TL	120
SFC 2/12 MC NE GE	Sarı / neutral	2,5 - 4,0 mm ²	1758320004	1,66 TL	120
SFC 2.5/12 MC NE WS	Beyaz / neutral	4,0 - 6,0 mm ²	1062000000	2,00 TL	120
SFC 2.5/12 MC NE GE	Sarı / neutral	4,0 - 6,0 mm ²	1062010000	2,00 TL	120
SFC 3/12 MC NE WS	Beyaz / neutral	4,0 - 10,0 mm ²	1025220000	2,27 TL	80
SFC 3/12 MC NE GE	Sarı / neutral	4,0 - 10,0 mm ²	1025230000	2,27 TL	80



SFC 0/21 MC NE WS



SFC 0/30 MC NE WS



SF 00/12 MC NE WS V2



SF 00/21 MC NE WS V2

Tip	Renk	Kablo Kesit	Sipariş No	Fiyat/Birim	Ambalaj
21 mm Uzunluk					
SFC 0/21 MC NE WS	Beyaz / neutral	0,5 - 1,0 mm ²	1813190000	1,66 TL	200
SFC 0/21 MC NE GE	Sarı / neutral	0,5 - 1,0 mm ²	1813210000	1,66 TL	200
SFC 1/21 MC NE WS	Beyaz / neutral	0,75 - 2,5 mm ²	1779080001	1,66 TL	200
SFC 1/21 MC NE GE	Sarı / neutral	0,75 - 2,5 mm ²	1779080004	1,66 TL	200
SFC 2/21 MC NE WS	Beyaz / neutral	2,5 - 4,0 mm ²	1805810000	1,81 TL	120
SFC 2/21 MC NE GE	Sarı / neutral	2,5 - 4,0 mm ²	1805780000	1,81 TL	120
SFC 2.5/21 MC NE WS	Beyaz / neutral	4,0 - 6,0 mm ²	1062050000	2,17 TL	120
SFC 2.5/21 MC NE GE	Sarı / neutral	4,0 - 6,0 mm ²	1062070000	2,17 TL	120
SFC 3/21 MC NE WS	Beyaz / neutral	4,0 - 10,0 mm ²	1025260000	2,52 TL	80
SFC 3/21 MC NE GE	Sarı / neutral	4,0 - 10,0 mm ²	1025270000	2,52 TL	80
30 mm Uzunluk					
SFC 0/30 MC NE WS	Beyaz / neutral	0,5 - 1,0 mm ²	1813240000	1,68 TL	150
SFC 0/30 MC NE GE	Sarı / neutral	0,5 - 1,0 mm ²	1813260000	1,68 TL	150
SFC 1/30 MC NE WS	Beyaz / neutral	0,75 - 2,5 mm ²	1805760000	1,68 TL	150
SFC 1/30 MC NE GE	Sarı / neutral	0,75 - 2,5 mm ²	1805730000	1,68 TL	150
SFC 2/30 MC NE WS	Beyaz / neutral	2,5 - 4,0 mm ²	1805870000	1,91 TL	90
SFC 2/30 MC NE GE	Sarı / neutral	2,5 - 4,0 mm ²	1805830000	1,91 TL	90
SFC 3/30 MC NE WS	Beyaz / neutral	4,0 - 10,0 mm ²	1025310000	2,82 TL	60
SFC 3/30 MC NE GE	Sarı / neutral	4,0 - 10,0 mm ²	1025320000	2,82 TL	60
SlimFix V2 - Kavramalı ve Geçmeli Tip Kablo Markalama					
12 mm Uzunluk					
SF 00/12 MC NE WS V2	Beyaz / neutral	< 0,25 mm ²	1919290000	1,39 TL	400
SF 00/12 MC NE GE V2	Sarı / neutral	< 0,25 mm ²	1919260000	1,39 TL	400
SF 0/12 MC NE WS V2	Beyaz / neutral	0,25 - 0,5 mm ²	1919240000	1,50 TL	400
SF 0/12 MC NE GE V2	Sarı / neutral	0,25 - 0,5 mm ²	1919210000	1,50 TL	400
SF 1/12 MC NE WS V2	Beyaz / neutral	0,5 - 0,75 mm ²	1919390000	1,50 TL	400
SFR 1/12 MC NE WS	Beyaz / neutral	0,5 - 0,75 mm ²	1318640000	1,81 TL	400
SF 1/12 MC NE GE V2	Sarı / neutral	0,5 - 0,75 mm ²	1919340000	1,50 TL	400
SFR 1/12 MC NE GE	Sarı / neutral	0,5 - 0,75 mm ²	1318650000	1,91 TL	400
SF 2/12 MC NE WS V2	Beyaz / neutral	0,75 - 1,5 mm ²	1919490000	1,61 TL	400
SFR 2/12 MC NE WS	Beyaz / neutral	0,75 - 1,5 mm ²	1318660000	2,00 TL	400
SF 2/12 MC NE GE V2	Sarı / neutral	0,75 - 1,5 mm ²	1919470000	1,61 TL	400
SFR 2/12 MC NE GE	Sarı / neutral	0,75 - 1,5 mm ²	1318670000	2,00 TL	400
SF 3/12 MC NE WS V2	Beyaz / neutral	1,5 - 2,5 mm ²	1919540000	1,68 TL	320
SFR 3/12 MC NE WS	Beyaz / neutral	1,5 - 2,5 mm ²	1318680000	2,09 TL	256
SF 3/12 MC NE GE V2	Sarı / neutral	1,5 - 2,5 mm ²	1919520000	1,69 TL	320
SFR 3/12 MC NE GE	Sarı / neutral	1,5 - 2,5 mm ²	1318690000	2,17 TL	256
SF 4/12 MC NE WS V2	Beyaz / neutral	2,5 - 4,0 mm ²	1919600000	1,75 TL	128
SF 4/12 MC NE GE V2	Sarı / neutral	2,5 - 4,0 mm ²	1919580000	1,75 TL	128
SF 5/12 MC NE WS V2	Beyaz / neutral	6,0 - 10,0 mm ²	1919650000	2,27 TL	160
SF 5/12 MC NE GE V2	Sarı / neutral	6,0 - 10,0 mm ²	1919620000	2,27 TL	160
21 mm Uzunluk					
SF 00/21 MC NE WS V2	Beyaz / neutral	< 0,25 mm ²	1918580000	1,39 TL	400
SF 00/21 MC NE GE V2	Sarı / neutral	< 0,25 mm ²	1918560000	1,39 TL	400
SF 0/21 MC NE WS V2	Beyaz / neutral	0,25 - 0,5 mm ²	1918500000	1,50 TL	400
SF 0/21 MC NE GE V2	Sarı / neutral	0,25 - 0,5 mm ²	1918480000	1,50 TL	400
SF 1/21 MC NE WS V2	Beyaz / neutral	0,5 - 0,75 mm ²	1918630000	1,61 TL	400
SFR 1/21 MC NE WS	Beyaz / neutral	0,5 - 0,75 mm ²	1318710000	2,00 TL	400
SF 1/21 MC NE GE V2	Sarı / neutral	0,5 - 0,75 mm ²	1918610000	1,61 TL	400

Serinin devamı sayfa 38



SFX 10/23 MC NE WS V2



SF-TOOL 00-6



TM-I 12 MC NE WS

Tip	Renk	Kablo Kesit	Sipariş No	Fiyat/Birim	Ambalaj
SFR 1/21 MC NE GE	Sarı / neutral	0,5 - 0,75 mm ²	1318720000	2,00 TL	400
SF 2/21 MC NE WS V2	Beyaz / neutral	0,75 - 1,5 mm ²	1918690000	1,69 TL	400
SFR 2/21 MC NE WS	Beyaz / neutral	0,75 - 1,5 mm ²	1318730000	2,09 TL	400
SF 2/21 MC NE GE V2	Sarı / neutral	0,75 - 1,5 mm ²	1918660000	1,69 TL	400
SFR 2/21 MC NE GE	Sarı / neutral	0,75 - 1,5 mm ²	1318740000	2,09 TL	400
SF 3/21 MC NE WS V2	Beyaz / neutral	1,5 - 2,5 mm ²	1918910000	1,81 TL	320
SFR 3/21 MC NE WS	Beyaz / neutral	1,5 - 2,5 mm ²	1318750000	2,17 TL	256
SF 3/21 MC NE GE V2	Sarı / neutral	1,5 - 2,5 mm ²	1918890000	1,81 TL	320
SFR 3/21 MC NE GE	Sarı / neutral	1,5 - 2,5 mm ²	1318760000	2,09 TL	256
SF 4/21 MC NE WS V2	Beyaz / neutral	2,5 - 4,0 mm ²	1919080000	1,81 TL	192
SF 4/21 MC NE GE V2	Sarı / neutral	2,5 - 4,0 mm ²	1919060000	1,81 TL	192
SF 4.5/21 MC NE WS V2	Beyaz / neutral	4,0 - 6,0 mm ²	1919020000	2,64 TL	96
SF 4.5/21 MC NE GE V2	Sarı / neutral	4,0 - 6,0 mm ²	1919000000	2,64 TL	96
SF 5/21 MC NE WS V2	Beyaz / neutral	6,0 - 10,0 mm ²	1919140000	3,12 TL	160
SF 5/21 MC NE GE V2	Sarı / neutral	6,0 - 10,0 mm ²	1919120000	3,12 TL	160
SF 6/21 MC NE WS V2	Beyaz / neutral	10,0 - 16,0 mm ²	1919190000	3,96 TL	160
SF 6/21 MC NE GE V2	Sarı / neutral	10,0 - 16,0 mm ²	1919170000	3,96 TL	160

SFX Kablo Bağı ile montaj

SFX 10/23 MC NE WS V2	Beyaz / neutral	16,0 mm ²	1852390000	5,46 TL	160
SFX 10/23 MC NE GE V2	Sarı / neutral	16,0 mm ²	1852360000	5,46 TL	160
SFX 14/23 MC NE WS V2	Beyaz / neutral	16,0 mm ²	1852440000	5,46 TL	160
SFX 14/23 MC NE GE V2	Sarı / neutral	16,0 mm ²	1852410000	5,46 TL	160
SFX 9/24 MC NE WS V2	Beyaz / neutral	16,0 mm ²	1852490000	5,46 TL	160
SFX 9/24 MC NE GE V2	Sarı / neutral	16,0 mm ²	1852460000	5,46 TL	160
SFX 11/60 MC NE WS	Beyaz / neutral	16,0 mm ²	1860120000	5,46 TL	60
SFX 11/60 MC NE GE	Sarı / neutral	16,0 mm ²	1860150000	5,46 TL	60
SFX 30/60 MC NE WS	Beyaz / neutral	40 mm ² ve üstü ölçüler için	1083230000	5,76 TL	30
SFX 30/60 MC NE GE	Sarı / neutral	40 mm ² ve üstü ölçüler için	1083240000	5,76 TL	30

Tip	Açıklama	Sipariş No	Fiyat/Birim	Ambalaj
SF - TOOL				
SF-TOOL 00-6	SlimFix	1950820000	1,00 €	10
SF-TOOL 1	SlimFix	1782970000	0,75 €	10
SF-TOOL 2-3	SlimFix	1782960000	0,90 €	10
SF-TOOL 4-5	SlimFix	1782980000	0,90 €	10

Tip	Renk	Sipariş No	Fiyat/Birim	Ambalaj
TM-I - Etiket				
TM-I 12 MC NE WS	Beyaz	1718411044	1,34 TL	320
TM-I 12 MC NE GE	Sarı	1718411687	1,34 TL	320
TM-I 15 MC NE WS	Beyaz	1609981044	1,40 TL	400
TM-I 15 MC NE GE	Sarı	1609981687	1,40 TL	400
TM-I 18 MC NE WS	Beyaz	1718431044	1,50 TL	320
TM-I 18 MC NE GE	Sarı	1718431687	1,50 TL	320
TM-I 20 MC NE WS	Beyaz	1680411044	1,50 TL	400
TM-I 20 MC NE GE	Sarı	1680411687	1,50 TL	400
TM-I 30 MC NE WS	Beyaz	1876390000	1,50 TL	300
TM-I 30 MC NE GE	Sarı	1876370000	1,50 TL	300

Tip	Uzunluk	Kablo Kesit	Sipariş No	Fiyat/Birim	Ambalaj
TM Şeffaf Kılıflar					
TM 201/12 VO	12 mm	0.25 - 1.5 mm ²	1798640000	0,314 TL	1000
TM 201/15 VO	15 mm	0.25 - 1.5 mm ²	1798620000	0,314 TL	1000
TM 201/18 VO	18 mm	0.25 - 1.5 mm ²	1798600000	0,439 TL	1000
TM 201/20 VO	20 mm	0.25 - 1.5 mm ²	1798580000	0,439 TL	1000
TM 201/30 VO	30 mm	0.25 - 1.5 mm ²	1874850000	0,590 TL	500
TM 202/12 VO	12 mm	0.5 - 2.5 mm ²	1798560000	0,337 TL	1000
TM 202/15 VO	15 mm	0.5 - 2.5 mm ²	1798540000	0,337 TL	1000
TM 202/18 VO	18 mm	0.5 - 2.5 mm ²	1798530000	0,462 TL	1000
TM 202/20 VO	20 mm	0.5 - 2.5 mm ²	1798520000	0,462 TL	1000
TM 202/30 VO	30 mm	0.5 - 2.5 mm ²	1874760000	0,690 TL	500
TM 203/12 VO	12 mm	2.5 - 10 mm ²	1798510000	0,401 TL	500
TM 203/15 VO	15 mm	2.5 - 10 mm ²	1798490000	0,401 TL	500
TM 203/18 VO	18 mm	2.5 - 10 mm ²	1798480000	0,575 TL	500
TM 203/20 VO	20 mm	2.5 - 10 mm ²	1798470000	0,575 TL	500
TM 203/30 VO	30 mm	2.5 - 10 mm ²	1874770000	0,889 TL	200
TM 204/12 VO	12 mm	6 - 16 mm ²	1806180000	0,475 TL	500
TM 204/15 VO	15 mm	6 - 16 mm ²	1806240000	0,475 TL	500
TM 204/18 VO	18 mm	6 - 16 mm ²	1806300000	0,677 TL	500
TM 204/20 VO	20 mm	6 - 16 mm ²	1806360000	0,677 TL	500
TM 204/30 VO	30 mm	6 - 16 mm ²	1874780000	1,15 TL	200
TM 205/12 VO	12 mm	16 - 35 mm ²	1806190000	1,10 TL	200
TM 205/15 VO	15 mm	16 - 35 mm ²	1806250000	1,27 TL	200
TM 205/18 VO	18 mm	16 - 35 mm ²	1806310000	1,39 TL	200
TM 205/20 VO	20 mm	16 - 35 mm ²	1806370000	1,48 TL	200
TM 205/30 VO	30 mm	16 - 35 mm ²	1874790000	2,40 TL	200
CLI T Şeffaf Kılıflar					
CLI T 02-12	12 mm	0.22 - 1.5 mm ²	1764060000	0,401 TL	200
CLI T 02-15	15 mm	0.22 - 1.5 mm ²	1764070000	0,401 TL	200
CLI T 02-18	18 mm	0.22 - 1.5 mm ²	1764140000	0,401 TL	200
CLI T 02-20	20 mm	0.22 - 1.5 mm ²	1764150000	0,539 TL	200
CLI T 02-30	30 mm	0.22 - 1.5 mm ²	1889580000	0,539 TL	200
CLI T 1-12	12 mm	0.75 - 6 mm ²	1764190000	0,439 TL	200
CLI T 1-15	15 mm	0.75 - 6 mm ²	1764200000	0,439 TL	200
CLI T 1-18	18 mm	0.75 - 6 mm ²	1764210000	0,439 TL	200
CLI T 1-20	20 mm	0.75 - 6 mm ²	1764220000	0,638 TL	200
CLI T 1-30	30 mm	0.75 - 6 mm ²	1889560000	0,638 TL	200
CLI T 2-12	12 mm	4 - 35 mm ²	1764230000	1,00 TL	100
CLI T 2-15	15 mm	4 - 35 mm ²	1764240000	1,00 TL	100
CLI T 2-18	18 mm	4 - 35 mm ²	1764250000	1,00 TL	100
CLI T 2-20	20 mm	4 - 35 mm ²	1764260000	1,00 TL	100
CLI T 2-30	30 mm	4 - 35 mm ²	1889570000	1,46 TL	100
CLI T 3-12	12 mm	25 - 75 mm ²	1764270000	1,91 TL	100
CLI T 3-15	15 mm	25 - 75 mm ²	1764280000	1,91 TL	100
CLI T 3-18	18 mm	25 - 75 mm ²	1764290000	1,91 TL	100
CLI T 3-20	20 mm	25 - 75 mm ²	1764300000	1,91 TL	100
CLI T 3-30	30 mm	25 - 75 mm ²	1889550000	1,91 TL	100
DMC 12/27 - Kablo Markalama					
DMC 12/27 MC NE WS	12,0 x 27,0 mm	0,5 - 10,0 mm ²	1016030000	2,82 TL	50
DMC 12/27 MC NE GE	12,0 x 27,0 mm	0,5 - 10,0 mm ²	1018190000	2,82 TL	50



TM 201/12 VO



TM 201/18 VO



CLI T 02-12



DMC 12/27 MC NE WS



SM 27/8 MC NE WS



SM 27/18 K MC NE WS



CC 15/17 MC NE WS

Tip	Renk	Açıklama	Sipariş No	Fiyat/Birim	Ambalaj
SwitchMark SM - Push Butonlar İçin					
SM 27/8 MC NE WS	Beyaz	Yapışkansız	1699820000	4,38 TL	80
SM 27/8 MC NE SI	Gri	Yapışkansız	1713680000	4,38 TL	80
SM 27/8 K MC NE WS	Beyaz	Yapışkanlı	1812630000	8,04 TL	80
SM 27/8 K MC NE SI	Gri	Yapışkanlı	1771930000	8,04 TL	80
SM 27/12.5 MC NE WS	Beyaz	Yapışkansız	1699840000	4,68 TL	80
SM 27/12.5 MC NE SI	Gri	Yapışkansız	1713700000	4,68 TL	80
SM 27/12.5 K MC NE WS	Beyaz	Yapışkanlı	1699880000	7,80 TL	80
SM 27/12.5 K MC NE SI	Gri	Yapışkanlı	1713720000	7,80 TL	80
SM-H 27/12.5 SW	Siyah	Taşıyıcı	1716640000	5,94 TL	25
SM 27/18 MC NE WS	Beyaz	Yapışkansız	1699860000	4,98 TL	80
SM 27/18 MC NE SI	Gri	Yapışkansız	1713740000	4,98 TL	80
SM 27/18 K MC NE WS	Beyaz	Yapışkanlı	1707270000	7,80 TL	80
SM 27/18 K MC NE SI	Gri	Yapışkanlı	1713760000	7,80 TL	80
SM-H 27/18 SW	Siyah	Taşıyıcı	1716630000	6,06 TL	25
SM 27/27 MC NE WS	Beyaz	Yapışkansız	1773220000	4,98 TL	60
SM 27/27 MC NE SI	Gümüş	Yapışkansız	1773230000	4,98 TL	60
SM 27/27 K MC NE WS	Beyaz	Yapışkanlı	1783000000	7,80 TL	60
SM 27/27 K MC NE SI	Gri	Yapışkanlı	1782990000	7,80 TL	60
SM-H 27/27 SW	Siyah	Taşıyıcı	1782710000	6,30 TL	10
SM 18/9.5 K MC NE WS	Beyaz	Yapışkanlı	1248580000	7,50 TL	200
SM 18/9.5 K MC NE GE	Sarı	Yapışkanlı	1248590000	7,50 TL	200
SM 18/9.5 K MC NE GR	Gri	Yapışkanlı	1248610000	7,50 TL	200
SM 19/42 K MC NE WS	Beyaz	Yapışkanlı	1248620000	10,30 TL	40
SM 19/42 K MC NE GE	Sarı	Yapışkanlı	1248630000	10,30 TL	40
SM 19/42 K MC NE GR	Gri	Yapışkanlı	1248640000	10,30 TL	40
SM 45/45-24 MC NE WS	Beyaz	Yapışkansız	1248650000	15,05 TL	20
SM 45/45-24 MC NE GE	Sarı	Yapışkansız	1248660000	15,05 TL	20
SM 45/45-24 MC NE GR	Gri	Yapışkansız	1248670000	15,05 TL	20
ClipCard Multikartları					
CC 15/17 MC NE WS	Beyaz	Yapışkansız	1876570000	3,36 TL	80
CC 15/17 MC NE SI	Gri	Yapışkansız	1876610000	3,36 TL	80
CC 15/17 K MC NE WS	Beyaz	Yapışkanlı	1876590000	3,60 TL	80
CC 15/17 K MC NE SI	Gri	Yapışkanlı	1876580000	3,60 TL	80
CC-H 15/17	Siyah	Taşıyıcı	1790430000	9,36 TL	75
CC 15/27 MC NE WS	Beyaz	Yapışkansız	1876770000	3,60 TL	80
CC 15/27 MC NE SI	Gri	Yapışkansız	1876760000	3,60 TL	80
CC 15/27 K MC NE WS	Beyaz	Yapışkanlı	1876640000	3,96 TL	80
CC 15/27 K MC NE SI	Gri	Yapışkanlı	1876780000	3,96 TL	80
CC-H 15/27	Siyah	Taşıyıcı	1790410000	9,66 TL	45
CC 15/49 MC NE WS	Beyaz	Yapışkansız	1877260000	3,96 TL	40
CC 15/49 MC NE SI	Gri	Yapışkansız	1877240000	3,96 TL	40
CC 15/49 K MC NE WS	Beyaz	Yapışkanlı	1877220000	4,98 TL	40
CC 15/49 K MC NE SI	Gri	Yapışkanlı	1877270000	4,98 TL	40
CC-H 15/49	Siyah	Taşıyıcı	1790420000	10,55 TL	25
CC 15/60 MC NE WS	Beyaz	Yapışkansız	1877350000	4,56 TL	40
CC 15/60 MC NE SI	Gri	Yapışkansız	1877340000	4,56 TL	40
CC 15/60 K MC NE WS	Beyaz	Yapışkanlı	1877310000	5,22 TL	40
CC 15/60 K MC NE SI	Gri	Yapışkanlı	1877360000	5,22 TL	40
CC-H 15/60	Siyah	Taşıyıcı	1878910000	11,90 TL	25
CC 30/60 MC NE WS	Beyaz	Yapışkansız	1934420000	4,98 TL	30

Serinin devamı sayfa 41



CC 85/54 MC NE WS



ESG 6/15 K MC NE WS



CC-M 85/54 AL



CC-M DIA 30 AL

Tip	Renk	Açıklama	Sipariş No	Fiyat/Birim	Ambalaj
CC 30/60 MC NE SI	Gri	Yapışkansız	1934400000	4,98 TL	30
CC 30/60 K MC NE WS	Beyaz	Yapışkanlı	1934390000	5,22 TL	30
CC 30/60 K MC NE SI	Gri	Yapışkanlı	1934330000	5,22 TL	30
CC-H 30/60	Siyah	Taşıyıcı	1934430000	12,50 TL	10
CC 85/54 MC NE WS	Beyaz	Yapışkansız	1138400000	20,75 TL	10
CC 85/54 MC NE GR	Gri	Yapışkansız	1138420000	20,75 TL	10
CC 85/54 K MC NE WS	Beyaz	Yapışkanlı	1138430000	24,30 TL	10
CC 85/54 K MC NE GR	Gri	Yapışkanlı	1138450000	24,30 TL	10

ESG Cihaz Markalama - Multikart

ESG 6/15 K MC NE WS	Beyaz	Yapışkanlı	1880100000	2,70 TL	200
ESG 6/15 K MC NE GE	Sarı	Yapışkanlı	1880130000	4,44 TL	200
ESG 6/15 RIDER MC NE WS	Beyaz	Yapışkanlı	1881280000	0,803 TL	200
ESG 6/17 K MC NE WS	Beyaz	Yapışkanlı	1880120000	2,70 TL	200
ESG 6/17 K MC NE GE	Sarı	Yapışkanlı	1880110000	2,70 TL	200
ESG 7/20 SIRIUS MC NE WS	Beyaz	Yapışkansız	1736181044	2,36 TL	200
ESG 7/20 SIRIUS MC NE TU	Turkuaz	Yapışkansız	1736181696	2,36 TL	200
ESG 8/17 MC NE WS	Beyaz	Yapışkansız	1674740000	2,17 TL	200
ESG 9/11 K MC NE WS	Beyaz	Yapışkanlı	1857440000	2,82 TL	200
ESG 9/17 K MC NE WS	Beyaz	Yapışkanlı	1674760000	3,60 TL	200
ESG 9/17 K MC NE GE	Sarı	Yapışkanlı	1753500000	3,18 TL	200
ESG 9/20 MC NE WS	Beyaz	Yapışkansız	1609940000	2,27 TL	200
ESG 9/20 MC NE TK	Turkuaz	Yapışkansız	1866690000	2,27 TL	200

Tip	Açıklama	Sipariş No	Fiyat/Birim	Ambalaj
Metal Markalama				
CC-M 85/54 AL	Alüminyum Metal Kart	1327600000	64,10 TL	40
CC-M 85/54 ST	Paslanmaz Çelik Metal Kart	1327620000	96,35 TL	40
CC-M 27/18 AL	Alüminyum Metal Kart	1327630000	12,70 TL	200
CC-M 27/18 ST	Paslanmaz Çelik Metal Kart	1327640000	17,80 TL	200
CC-M 85/27 AL	Alüminyum Metal Kart	1327650000	40,15 TL	80
CC-M 85/27 ST	Paslanmaz Çelik Metal Kart	1327670000	51,60 TL	80
CC-M 30/60 ST	Paslanmaz Çelik Metal Kart	1327690000	39,60 TL	100
CC-M 15/60 AL	Alüminyum Metal Kart	1327700000	15,70 TL	200
CC-M 15/60 ST	Paslanmaz Çelik Metal Kart	1327720000	21,85 TL	200
CC-M 15/45 AL	Alüminyum Metal Kart	1327730000	13,00 TL	200
CC-M 15/45 ST	Paslanmaz Çelik Metal Kart	1327740000	19,20 TL	200
CC-M DIA 30 AL	Alüminyum Metal Kart	1327750000	15,70 TL	200
CC-M DIA 30 ST	Paslanmaz Çelik Metal Kart	1327770000	20,75 TL	200
SFX-M 11/60 AL	Alüminyum Metal Kart - Kablo Markalaması	1327780000	19,20 TL	50
SFX-M 11/60 ST	Paslanmaz Çelik Metal Kart - Kablo Markalaması	1327790000	24,05 TL	50
CC-M 85/54 4X3 AL	Üzerinde 4 Adet Puntolama Deliği Olan Alüminyum Tip	1327800000	64,10 TL	40
CC-M 85/54 4X3 ST	Üzerinde 4 Adet Puntolama Deliği Olan Paslanmaz Çelik Tip	1327820000	96,35 TL	40
CC-M 85/27 2X3 AL	Üzerinde 2 Adet Puntolama Deliği Olan Alüminyum Tip	1327830000	40,15 TL	80
CC-M 85/27 2X3 ST	Üzerinde 2 Adet Puntolama Deliği Olan Paslanmaz Çelik Tip	1327840000	51,60 TL	80
CC-M 30/60 2X3 AL	Üzerinde 2 Adet Puntolama Deliği Olan Alüminyum Tip	1327850000	31,40 TL	100
CC-M 30/60 2X3 ST	Üzerinde 2 Adet Puntolama Deliği Olan Paslanmaz Çelik Tip	1327870000	39,60 TL	100
CC-M 15/60 2X3 AL	Üzerinde 2 Adet Puntolama Deliği Olan Alüminyum Tip	1327880000	15,70 TL	200
CC-M 15/60 2X3 ST	Üzerinde 2 Adet Puntolama Deliği Olan Paslanmaz Çelik Tip	1327890000	21,85 TL	200
CC-M 15/45 2X3 AL	Üzerinde 2 Adet Puntolama Deliği Olan Alüminyum Tip	1327900000	13,00 TL	200
CC-M 15/45 2X3 ST	Üzerinde 2 Adet Puntolama Deliği Olan Paslanmaz Çelik Tip	1327920000	19,20 TL	200
DKB CC 85/54	Metal Kartlar İçin Yapışkanlı Bant	1175850000	18,35 TL	100

Serinin devamı sayfa 42



DKB CC 27/18



INLAY CC-M 15/45



THM MT30X 15/6 WS



THM GEW 15/6 GE



DEK 5/3.5 MM WS

Tip	Açıklama	Sipariş No	Fiyat/Birim	Ambalaj
DKB CC 85/27	Metal Kartlar İçin Yapışkanlı Bant	1226620000	14,35 TL	100
CC-M 30/60 AL	Alüminyum Metal Kart	1327680000	31,40 TL	100
DKB CC 30/60	Metal Kartlar İçin Yapışkanlı Bant	1341130000	6,00 TL	100
DKB CC 27/18	Metal Kartlar İçin Yapışkanlı Bant	1341140000	2,52 TL	320
DKB CC 15/60	Metal Kartlar İçin Yapışkanlı Bant	1341150000	4,44 TL	160
DKB CC 15/45	Metal Kartlar İçin Yapışkanlı Bant	1341170000	3,60 TL	240
DKB CC DIA 30	Metal Kartlar İçin Yapışkanlı Bant	1341180000	3,84 TL	200
INLAY CC-M 85/54	Metal Kartlar İçin Taşıyıcı Aparat	1341030000	1.794,00 TL	1
INLAY CC-M 27/18	Metal Kartlar İçin Taşıyıcı Aparat	1341040000	1.794,00 TL	1
INLAY CC-M 85/27	Metal Kartlar İçin Taşıyıcı Aparat	1341050000	1.794,00 TL	1
INLAY CC-M 30/60	Metal Kartlar İçin Taşıyıcı Aparat	1341070000	1.794,00 TL	1
INLAY CC-M 15/60	Metal Kartlar İçin Taşıyıcı Aparat	1341080000	1.794,00 TL	1
INLAY CC-M 15/45	Metal Kartlar İçin Taşıyıcı Aparat	1341090000	1.794,00 TL	1
INLAY CC-M DIA 30	Metal Kartlar İçin Taşıyıcı Aparat	1341100000	1.794,00 TL	1
INLAY SFX-M 11/60	Metal Kartlar İçin Taşıyıcı Aparat	1341110000	1.794,00 TL	1
INLAY CC-M UNIVERSAL	Metal Kartlar İçin Taşıyıcı Aparat	1341120000	2.690,00 TL	1

Tip	Açıklama	Renk / Materyal	Sipariş No	Fiyat/Birim	Ambalaj
THM - Cihaz ve İletken Markalaması					
THM MT30X 15/6 WS	10.000 / Rulo	Beyaz - Polyester Film	1753231044	3.418,00 TL	1
THM MT30X 15/6 GE	10.000 / Rulo	Sarı - Polyester Film	1753231687	3.418,00 TL	1
THM MT30X 17/9 WS	10.000 / Rulo	Beyaz - Polyester Film	1968130000	3.732,00 TL	1
THM MT30X 17/9 GE	10.000 / Rulo	Sarı - Polyester Film	1856650000	3.732,00 TL	1
THM MT30X 20/8 WS	10.000 / Rulo	Beyaz - Polyester Film	1753241044	3.418,00 TL	1
THM MT30X 20/8 GE	10.000 / Rulo	Sarı - Polyester Film	1753241687	3.418,00 TL	1
THM MT30X 25/12 WS	10.000 / Rulo	Beyaz - Polyester Film	1751751044	5.609,00 TL	1
THM MT30X 25/12 GE	10.000 / Rulo	Sarı - Polyester Film	1751751687	5.609,00 TL	1
THM MT30X 45/23 WS	2.000 / Rulo	Beyaz - Polyester Film	1751811044	2.500,00 TL	1
THM MT30X 45/23 GE	2.000 / Rulo	Sarı - Polyester Film	1751811687	2.312,00 TL	1
THM MT30X 65/35 WS	1.000 / Rulo	Beyaz - Polyester Film	1751831044	2.656,00 TL	1
THM MT30X 65/35 GE	1.000 / Rulo	Sarı - Polyester Film	1751831687	2.656,00 TL	1
THM GEW 15/6 WS	10.000 / Rulo	Beyaz - Tekstil Kağıdı	1059780000	4.220,00 TL	1
THM GEW 15/6 GE	10.000 / Rulo	Sarı - Tekstil Kağıdı	1059790000	4.220,00 TL	1
THM GEW 17/9 WS	10.000 / Rulo	Beyaz - Tekstil Kağıdı	1059800000	4.220,00 TL	1
THM GEW 17/9 GE	10.000 / Rulo	Sarı - Tekstil Kağıdı	1059810000	4.220,00 TL	1
THM GEW 20/8 WS	10.000 / Rulo	Beyaz - Tekstil Kağıdı	1059870000	4.220,00 TL	1
THM GEW 20/8 GE	10.000 / Rulo	Sarı - Tekstil Kağıdı	1059880000	4.220,00 TL	1

Tip	Renk	Birlikte Kullanılacak Ribon	Sipariş No	Fiyat/Birim	Ambalaj
Multimark Etiket Grupları					
Klemens Markalama DEK, WS					
DEK 5/3.5 MM WS	Beyaz	RIBBON MM-TB 25/360 SW	2007100000	0,340 TL	1000
DEK 5/5 MM WS	Beyaz	RIBBON MM-TB 25/360 SW	2007110000	0,350 TL	800
DEK 5/6 MM WS	Beyaz	RIBBON MM-TB 25/360 SW	2007120000	0,350 TL	600
DEK 5/8 MM WS	Beyaz	RIBBON MM-TB 25/360 SW	2007130000	0,380 TL	500
WS 8/3.5 MM WS	Beyaz	RIBBON MM-TB 25/360 SW	2007140000	0,412 TL	1000
WS 8/5 MM WS	Beyaz	RIBBON MM-TB 25/360 SW	2007150000	0,420 TL	800
WS 8/6 MM WS	Beyaz	RIBBON MM-TB 25/360 SW	2007160000	0,440 TL	600
WS 8/8 MM WS	Beyaz	RIBBON MM-TB 25/360 SW	2007170000	0,462 TL	500
WS 12/3.5 MM WS	Beyaz	RIBBON MM-TB 25/360 SW	2007180000	0,440 TL	1000
WS 12/5 MM WS	Beyaz	RIBBON MM-TB 25/360 SW	2007190000	0,456 TL	800
WS 12/6 MM WS	Beyaz	RIBBON MM-TB 25/360 SW	2007200000	0,460 TL	600
WS 12/8 MM WS	Beyaz	RIBBON MM-TB 25/360 SW	2007210000	0,500 TL	500

Tip	Renk	Birlikte Kullanılacak Ribon	Sipariş No	Fiyat/Birim	Ambalaj
Kablo Markalama TM-I					
TM-I 12 MM BL	Mavi	RIBBON MM 80/360 SW	2005890000	0,788 TL	2000
TM-I 12 MM GE	Sarı	RIBBON MM 80/360 SW	2005550000	0,800 TL	2000
TM-I 12 MM RT	Kırmızı	RIBBON MM 80/360 SW	2005730000	0,788 TL	2000
TM-I 12 MM WS	Beyaz	RIBBON MM 80/360 SW	2005440000	0,788 TL	2000
TM-I 15 MM BL	Mavi	RIBBON MM 80/360 SW	2005910000	0,839 TL	2000
TM-I 15 MM GE	Sarı	RIBBON MM 80/360 SW	2005580000	0,839 TL	2000
TM-I 15 MM RT	Kırmızı	RIBBON MM 80/360 SW	2005760000	0,839 TL	2000
TM-I 15 MM WS	Beyaz	RIBBON MM 80/360 SW	2005450000	0,850 TL	2000
TM-I 18 MM BL	Mavi	RIBBON MM 80/360 SW	2005930000	0,889 TL	2000
TM-I 18 MM GE	Sarı	RIBBON MM 80/360 SW	2005610000	0,889 TL	2000
TM-I 18 MM RT	Kırmızı	RIBBON MM 80/360 SW	2005790000	0,889 TL	2000
TM-I 18 MM WS	Beyaz	RIBBON MM 80/360 SW	2005470000	0,889 TL	2000
TM-I 20 MM BL	Mavi	RIBBON MM 80/360 SW	2005950000	0,928 TL	2000
TM-I 20 MM GE	Sarı	RIBBON MM 80/360 SW	2005640000	0,920 TL	2000
TM-I 20 MM RT	Kırmızı	RIBBON MM 80/360 SW	2005820000	0,928 TL	2000
TM-I 20 MM WS	Beyaz	RIBBON MM 80/360 SW	2005490000	0,920 TL	2000
TM-I 23 MM BL	Mavi	RIBBON MM 80/360 SW	2005970000	0,964 TL	2000
TM-I 23 MM GE	Sarı	RIBBON MM 80/360 SW	2005670000	0,964 TL	2000
TM-I 23 MM RT	Kırmızı	RIBBON MM 80/360 SW	2005850000	0,964 TL	2000
TM-I 23 MM WS	Beyaz	RIBBON MM 80/360 SW	2005510000	0,964 TL	2000
TM-I 30 MM BL	Mavi	RIBBON MM 80/360 SW	2005990000	1,05 TL	2000
TM-I 30 MM GE	Sarı	RIBBON MM 80/360 SW	2005700000	1,05 TL	2000
TM-I 30 MM RT	Kırmızı	RIBBON MM 80/360 SW	2005870000	1,05 TL	2000
TM-I 30 MM WS	Beyaz	RIBBON MM 80/360 SW	2005530000	1,10 TL	2000
Kablo Markalama WM					
WM 0/12 1.0-2.0 MM GE	Sarı - 0.5 - 0.75 mm ²	RIBBON MM 80/360 SW	2006250000	0,702 TL	2000
WM 0/12 1.0-2.0 MM WS	Beyaz - 0.5 - 0.75 mm ²	RIBBON MM 80/360 SW	2006170000	0,900 TL	2000
WM 0/21 1.0-2.0 MM GE	Sarı - 0.5 - 0.75 mm ²	RIBBON MM 80/360 SW	2006090000	0,763 TL	2000
WM 0/21 1.0-2.0 MM WS	Beyaz - 0.5 - 0.75 mm ²	RIBBON MM 80/360 SW	2006010000	0,763 TL	2000
WM 0/6 1.0-2.0 MM GE	Sarı - 0.5 - 0.75 mm ²	RIBBON MM 80/360 SW	2006410000	0,671 TL	2000
WM 0/6 1.0-2.0 MM WS	Beyaz - 0.5 - 0.75 mm ²	RIBBON MM 80/360 SW	2006330000	0,671 TL	2000
WM 1/12 2.0-3.5 MM GE	Sarı - 0.75 - 2.5 mm ²	RIBBON MM 80/360 SW	2006270000	0,763 TL	2000
WM 1/12 2.0-3.5 MM WS	Beyaz - 0.75 - 2.5 mm ²	RIBBON MM 80/360 SW	2006190000	0,900 TL	2000
WM 1/21 2.0-3.5 MM GE	Sarı - 0.75 - 2.5 mm ²	RIBBON MM 80/360 SW	2006110000	0,793 TL	2000
WM 1/21 2.0-3.5 MM WS	Beyaz - 0.75 - 2.5 mm ²	RIBBON MM 80/360 SW	2006030000	0,850 TL	2000
WM 1/6 2.0-3.5 MM GE	Sarı - 0.75 - 2.5 mm ²	RIBBON MM 80/360 SW	2006430000	0,702 TL	2000
WM 1/6 2.0-3.5 MM WS	Beyaz - 0.75 - 2.5 mm ²	RIBBON MM 80/360 SW	2006350000	0,702 TL	2000
WM 2/12 3.5-5.0 MM GE	Sarı - 2.5 - 4.0 mm ²	RIBBON MM 80/360 SW	2006290000	0,880 TL	2000
WM 2/12 3.5-5.0 MM WS	Beyaz - 2.5 - 4.0 mm ²	RIBBON MM 80/360 SW	2006210000	0,900 TL	2000
WM 2/21 3.5-5.0 MM GE	Sarı - 2.5 - 4.0 mm ²	RIBBON MM 80/360 SW	2006130000	0,946 TL	2000
WM 2/21 3.5-5.0 MM WS	Beyaz - 2.5 - 4.0 mm ²	RIBBON MM 80/360 SW	2006050000	0,946 TL	2000
WM 2/6 3.5-5.0 MM GE	Sarı - 2.5 - 4.0 mm ²	RIBBON MM 80/360 SW	2006450000	0,805 TL	2000
WM 2/6 3.5-5.0 MM WS	Beyaz - 2.5 - 4.0 mm ²	RIBBON MM 80/360 SW	2006370000	0,805 TL	2000
WM 3/12 5.0-8.0 MM GE	Sarı - 4.0 - 16 mm ²	RIBBON MM 80/360 SW	2006310000	1,07 TL	2000
WM 3/12 5.0-8.0 MM WS	Beyaz - 4.0 - 16 mm ²	RIBBON MM 80/360 SW	2006230000	1,10 TL	2000
WM 3/21 5.0-8.0 MM GE	Sarı - 4.0 - 16 mm ²	RIBBON MM 80/360 SW	2006150000	1,16 TL	2000
WM 3/21 5.0-8.0 MM WS	Beyaz - 4.0 - 16 mm ²	RIBBON MM 80/360 SW	2006070000	1,16 TL	2000
WM 3/6 5.0-8.0 MM GE	Sarı - 4.0 - 16 mm ²	RIBBON MM 80/360 SW	2006470000	0,964 TL	2000
WM 3/6 5.0-8.0 MM WS	Beyaz - 4.0 - 16 mm ²	RIBBON MM 80/360 SW	2006390000	0,964 TL	2000



TM-I 12 MM BL



TM-I 20 MM GE



WM 0/12 1.0-2.0 MM GE



WM 2/12 3.5-5.0 MM WS



SFX 9/24 MM GE



ELS 6/30 MM GE



ESG 6/17 MM SW



ESG 6/17 MM GE



ESG 8/20 MM GR



SM 27/12.5 MM GN

Tip	Renk	Birlikte Kullanılacak Ribon	Sipariş No	Fiyat/Birim	Ambalaj
Kablo Markalama SFX					
SFX 9/24 MM GE	Sarı	RIBBON MM 80/360 SW	2005380000	2,80 TL	1000
SFX 9/24 MM WS	Beyaz	RIBBON MM 80/360 SW	2005320000	2,80 TL	1000
SFX 11/60 MM GE	Sarı	RIBBON MM 80/360 SW	2005400000	3,36 TL	1000
SFX 11/60 MM WS	Beyaz	RIBBON MM 80/360 SW	2005340000	3,36 TL	1000
SFX 30/60 MM GE	Sarı	RIBBON MM 80/360 SW	2005420000	5,40 TL	300
SFX 30/60 MM WS	Beyaz	RIBBON MM 80/360 SW	2005360000	5,40 TL	300
Kablo Markalama ELS Taşıyıcı Kılıf İçi Markalama Yüzeyleri					
ELS 6/30 MM GE	Sarı	RIBBON MM 80/360 SW	2010620000	1,37 TL	3000
ELS 6/30 MM WS	Beyaz	RIBBON MM 80/360 SW	2009980000	1,37 TL	3000
ELS 8/20 MM GE	Sarı	RIBBON MM 80/360 SW	2005240000	1,18 TL	3000
ELS 8/20 MM WS	Beyaz	RIBBON MM 80/360 SW	2005180000	1,18 TL	3000
ELS 16/40 MM GE	Sarı	RIBBON MM 80/360 SW	2005260000	1,81 TL	2000
ELS 16/40 MM WS	Beyaz	RIBBON MM 80/360 SW	2005200000	1,81 TL	2000
Cihaz Markalama ESG, SM					
ESG 6/17 MM GE	Sarı	RIBBON MM 80/360 SW	2005110000	1,17 TL	3000
ESG 6/17 MM GR	Gri	RIBBON MM 80/360 SW	2005120000	1,17 TL	3000
ESG 6/17 MM SW	Siyah	RIBBON MM 80/300 WS	2005130000	1,17 TL	3000
ESG 6/17 MM WS	Beyaz	RIBBON MM 80/360 SW	2005100000	1,30 TL	3000
ESG 8/20 MM GE	Sarı	RIBBON MM 80/360 SW	2005150000	1,22 TL	3000
ESG 8/20 MM GR	Gri	RIBBON MM 80/360 SW	2005160000	1,22 TL	3000
ESG 8/20 MM SW	Siyah	RIBBON MM 80/300 WS	2005170000	1,22 TL	3000
ESG 8/20 MM WS	Beyaz	RIBBON MM 80/360 SW	2005140000	1,22 TL	3000
ESG 9/17 MM GE	Sarı	RIBBON MM 80/360 SW	2005210000	1,55 TL	3000
ESG 9/17 MM GR	Gri	RIBBON MM 80/360 SW	2005230000	1,55 TL	3000
ESG 9/17 MM SW	Siyah	RIBBON MM 80/300 WS	2005250000	1,55 TL	3000
ESG 9/17 MM WS	Beyaz	RIBBON MM 80/360 SW	2005190000	1,55 TL	3000
SM 18/9.5 MM GE	Sarı	RIBBON MM 80/360 SW	2006240000	3,60 TL	1000
SM 18/9.5 MM GR	Gri	RIBBON MM 80/360 SW	2006260000	3,60 TL	1000
SM 18/9.5 MM SW	Siyah	RIBBON MM 80/300 WS	2006200000	3,60 TL	1000
SM 18/9.5 MM WS	Beyaz	RIBBON MM 80/360 SW	2006220000	3,60 TL	1000
SM 27/8 MM GE	Sarı	RIBBON MM 80/360 SW	2006420000	2,70 TL	1000
SM 27/8 MM GN	Yeşil	RIBBON MM 80/360 SW	2006490000	2,70 TL	1000
SM 27/8 MM GR	Gri	RIBBON MM 80/360 SW	2006480000	2,70 TL	1000
SM 27/8 MM RT	Kırmızı	RIBBON MM 80/360 SW	2006460000	2,70 TL	1000
SM 27/8 MM SW	Siyah	RIBBON MM 80/300 WS	2006440000	2,70 TL	1000
SM 27/8 MM WS	Beyaz	RIBBON MM 80/360 SW	2006400000	2,70 TL	1000
SM 27/12.5 MM GE	Sarı	RIBBON MM 80/360 SW	2006510000	3,30 TL	1000
SM 27/12.5 MM GN	Yeşil	RIBBON MM 80/360 SW	2006550000	3,30 TL	1000
SM 27/12.5 MM GR	Gri	RIBBON MM 80/360 SW	2006520000	3,30 TL	1000
SM 27/12.5 MM RT	Kırmızı	RIBBON MM 80/360 SW	2006540000	3,30 TL	1000
SM 27/12.5 MM SW	Siyah	RIBBON MM 80/300 WS	2006530000	3,30 TL	1000
SM 27/12.5 MM WS	Beyaz	RIBBON MM 80/360 SW	2006500000	3,30 TL	1000
SM 27/18 MM GE	Sarı	RIBBON MM 80/360 SW	2006300000	4,14 TL	1000
SM 27/18 MM GN	Yeşil	RIBBON MM 80/360 SW	2006380000	4,14 TL	1000
SM 27/18 MM GR	Gri	RIBBON MM 80/360 SW	2006340000	4,14 TL	1000
SM 27/18 MM RT	Kırmızı	RIBBON MM 80/360 SW	2006360000	4,14 TL	1000
SM 27/18 MM SW	Siyah	RIBBON MM 80/300 WS	2006320000	4,14 TL	1000
SM 27/18 MM WS	Beyaz	RIBBON MM 80/360 SW	2006280000	4,20 TL	1000
SM 27/18-22 MM GE	Sarı	RIBBON MM 80/360 SW	2005810000	6,70 TL	1000
SM 27/18-22 MM GN	Yeşil	RIBBON MM 80/360 SW	2005920000	6,54 TL	1000

Serinin devamı sayfa 45

Tip	Renk	Birlikte Kullanılacak Ribon	Sipariş No	Fiyat/Birim	Ambalaj
SM 27/18-22 MM GR	Gri	RIBBON MM 80/360 SW	2005860000	6,70 TL	1000
SM 27/18-22 MM RT	Kırmızı	RIBBON MM 80/360 SW	2005900000	6,54 TL	1000
SM 27/18-22 MM SW	Siyah	RIBBON MM 80/300 WS	2005880000	6,54 TL	1000
SM 27/18-22 MM WS	Beyaz	RIBBON MM 80/360 SW	2005840000	6,70 TL	1000
SM 36/18-30 MM GE	Sarı	RIBBON MM 80/360 SW	2006080000	7,20 TL	1000
SM 36/18-30 MM GN	Yeşil	RIBBON MM 80/360 SW	2006180000	7,20 TL	1000
Cihaz Markalama SM, CC, EL					
SM 36/18-30 MM GR	Gri	RIBBON MM 80/360 SW	2006120000	7,20 TL	1000
SM 36/18-30 MM RT	Kırmızı	RIBBON MM 80/360 SW	2006160000	7,20 TL	1000
SM 36/18-30 MM SW	Siyah	RIBBON MM 80/300 WS	2006140000	7,20 TL	1000
SM 36/18-30 MM WS	Beyaz	RIBBON MM 80/360 SW	2006100000	7,20 TL	1000
SM DIA 60-22 MM GE	Sarı	RIBBON MM 80/360 SW	2006060000	9,80 TL	450
CC 15/27 MM GE	Sarı	RIBBON MM 80/360 SW	2005630000	1,50 TL	450
CC 15/27 MM GR	Gri	RIBBON MM 80/360 SW	2005660000	1,60 TL	450
CC 15/27 MM SW	Siyah	RIBBON MM 80/300 WS	2005690000	1,50 TL	450
CC 15/27 MM WS	Beyaz	RIBBON MM 80/360 SW	2005600000	1,50 TL	450
CC 15/45 MM GE	Sarı	RIBBON MM 80/360 SW	2005520000	2,40 TL	450
CC 15/45 MM GR	Gri	RIBBON MM 80/360 SW	2005540000	2,40 TL	450
CC 15/45 MM SW	Siyah	RIBBON MM 80/300 WS	2005570000	2,27 TL	450
CC 15/45 MM WS	Beyaz	RIBBON MM 80/360 SW	2005500000	2,40 TL	450
CC 15/60 MM GE	Sarı	RIBBON MM 80/360 SW	2005430000	2,82 TL	450
CC 15/60 MM GR	Gri	RIBBON MM 80/360 SW	2005460000	2,82 TL	450
CC 15/60 MM SW	Siyah	RIBBON MM 80/300 WS	2005480000	2,82 TL	450
CC 15/60 MM WS	Beyaz	RIBBON MM 80/360 SW	2005410000	2,82 TL	450
CC 30/60 MM GE	Sarı	RIBBON MM 80/360 SW	2005350000	5,76 TL	450
CC 30/60 MM GR	Gri	RIBBON MM 80/360 SW	2005370000	6,50 TL	450
CC 30/60 MM SW	Siyah	RIBBON MM 80/300 WS	2005390000	5,76 TL	450
CC 30/60 MM WS	Beyaz	RIBBON MM 80/360 SW	2005330000	6,50 TL	450
CC 85/54 MM GE	Sarı	RIBBON MM 80/360 SW	2005280000	17,00 TL	450
CC 85/54 MM GR	Gri	RIBBON MM 80/360 SW	2005290000	17,00 TL	450
CC 85/54 MM SW	Siyah	RIBBON MM 80/300 WS	2005310000	14,70 TL	450
CC 85/54 MM WS	Beyaz	RIBBON MM 80/360 SW	2005270000	17,00 TL	450
EL 12 MM GE 30M	Sarı	RIBBON MM 80/360 SW	2006580000	480,00 TL	1
EL 12 MM WS 30M	Beyaz	RIBBON MM 80/360 SW	2006570000	463,20 TL	1
EL 15 MM GE 30M	Sarı	RIBBON MM 80/360 SW	2006600000	590,00 TL	1
EL 15 MM SI 30M	Gümüş	RIBBON MM 80/360 SW	2006610000	590,00 TL	1
EL 15 MM WS 30M	Beyaz	RIBBON MM 80/360 SW	2006590000	576,00 TL	1
EL 27 MM GE 30M	Sarı	RIBBON MM 80/360 SW	2006640000	1.100,00 TL	1
EL 27 MM SI 30M	Gümüş	RIBBON MM 80/360 SW	2006620000	1.040,00 TL	1
EL 27 MM WS 30M	Beyaz	RIBBON MM 80/360 SW	2006630000	1.100,00 TL	1
EL 38 MM GE 30M	Sarı	RIBBON MM 80/360 SW	2006670000	1.500,00 TL	1
EL 38 MM SI 30M	Gümüş	RIBBON MM 80/360 SW	2006650000	1.500,00 TL	1
EL 38 MM WS 30M	Beyaz	RIBBON MM 80/360 SW	2006660000	1.463,00 TL	1
EL 60 MM GE 30M	Sarı	RIBBON MM 80/360 SW	2006700000	2.298,00 TL	1
EL 60 MM SI 30M	Gümüş	RIBBON MM 80/360 SW	2006680000	2.298,00 TL	1
EL 60 MM WS 30M	Beyaz	RIBBON MM 80/360 SW	2006690000	2.298,00 TL	1
EL 100 MM GE 30M	Sarı	RIBBON MM 110/360 SW	2006730000	3.832,00 TL	1
EL 100 MM SI 30M	Gümüş	RIBBON MM 110/360 SW	2006710000	3.900,00 TL	1
EL 100 MM WS 30M	Beyaz	RIBBON MM 110/360 SW	2006720000	3.832,00 TL	1

Not: Markalamalar ile kullanılacak ribonlar "Cihaz Aksesuarları" başlığı altından haricen sipariş edilmelidir



SM 36/18-30 MM GR



CC 15/27 MM WS



EL 12 MM GE 30M



WKM 18/43



HSS-HF 1.2-2.4 EL Y13M



HSS-HF 12.7-25.4 EL W10M



LM MT300 15/6 WS

Tip	Açıklama	En / Boy	Sipariş No	Fiyat/Birim	Ambalaj
Kablo Markalama Yüzeyleri					
WKM 18/43	Kablo markalama	18 / 43 mm	1610700000	10,55 TL	50
WKM 8/20	Kablo markalama	8 / 20 mm	1753490000	10,00 TL	50
WKM 8/30	Kablo markalama	8 / 30 mm	1631910000	10,00 TL	50

Tip	Açıklama	Ölçü / Renk	Sipariş No	Fiyat/Birim	Ambalaj
Kablo Markalama Yüzeyleri					
ESO 5 DIN A4 WS	Beyaz, Tabaka/60	40 x 16,5 mm / Beyaz	1607710000	28,20 TL	10
ESO 7 DIN A4 WS	Beyaz, Tabaka/60	27 x 6,3 mm /Beyaz	1607720000	28,20 TL	10

Tip	Kesit	Ölçü	Sipariş No	Fiyat/Birim	Ambalaj
HSS Daralan Makoron - Şerit Tipi					
HSS-HF 1.2-2.4 EL Y13M	0.25 - 0.5 mm ² kablo çapı	13 Metre	1423220000	521,00 TL	1
HSS-HF 1.6-3.2 EL Y13M	0.5 - 1.5 mm ² kablo çapı	13 Metre	1423230000	553,00 TL	1
HSS-HF 2.4-4.8 EL Y13M	0.75 - 4 mm ² kablo çapı	13 Metre	1423240000	646,00 TL	1
HSS-HF 3.2-6.4 EL Y13M	1.5 - 6 mm ² kablo çapı	13 Metre	1423250000	778,00 TL	1
HSS-HF 4.8-9.5 EL Y13M	4.00 - 16 mm ² kablo çapı	13 Metre	1423260000	1.067,00 TL	1
HSS-HF 6.4-12.7 EL Y13M	6 - 35 mm ² kablo çapı	13 Metre	1423270000	1.229,00 TL	1
HSS-HF 9.5-19.1 EL Y10M	16 - 70 mm ² kablo çapı	10 Metre	1423280000	1.346,00 TL	1
HSS-HF 12.7-25.4 EL Y10M	35 - 120 mm ² kablo çapı	10 Metre	1423290000	1.903,00 TL	1
HSS-HF 1.2-2.4 EL W13M	0.25 - 0.5 mm ² kablo çapı	13 Metre	1423330000	518,00 TL	1
HSS-HF 1.6-3.2 EL W13M	0.5 - 1.5 mm ² kablo çapı	13 Metre	1423340000	553,00 TL	1
HSS-HF 2.4-4.8 EL W13M	0.75 - 4 mm ² kablo çapı	13 Metre	1423350000	646,00 TL	1
HSS-HF 3.2-6.4 EL W13M	1.5 - 6 mm ² kablo çapı	13 Metre	1423360000	778,00 TL	1
HSS-HF 4.8-9.5 EL W13M	4.00 - 16 mm ² kablo çapı	13 Metre	1423370000	1.067,00 TL	1
HSS-HF 6.4-12.7 EL W13M	6 - 35 mm ² kablo çapı	13 Metre	1423380000	1.229,00 TL	1
HSS-HF 9.5-19.1 EL W10M	16 - 70 mm ² kablo çapı	13 Metre	1423390000	1.346,00 TL	1
HSS-HF 12.7-25.4 EL W10M	35 - 120 mm ² kablo çapı	10 Metre	1423410000	1.903,00 TL	1
HSS-HF 1.2-2.4 EL Y30M	0.25 - 0.5 mm ² kablo çapı	10 Metre	1513140000	1.120,00 TL	1
HSS-HF 1.6-3.2 EL Y30M	0.5 - 1.5 mm ² kablo çapı	30 Metre	1513150000	1.188,00 TL	1
HSS-HF 2.4-4.8 EL Y30M	0.75 - 4 mm ² kablo çapı	30 Metre	1513170000	1.380,00 TL	1
HSS-HF 3.2-6.4 EL Y30M	1.5 - 6 mm ² kablo çapı	30 Metre	1513180000	1.676,00 TL	1
HSS-HF 4.8-9.5 EL Y30M	4.00 - 16 mm ² kablo çapı	30 Metre	1513190000	2.290,00 TL	1
HSS-HF 6.4-12.7 EL Y30M	6 - 35 mm ² kablo çapı	30 Metre	1513200000	2.632,00 TL	1
HSS-HF 9.5-19.1 EL Y30M	16 - 70 mm ² kablo çapı	30 Metre	1513220000	3.744,00 TL	1
HSS-HF 12.7-25.4 EL Y30M	35 - 120 mm ² kablo çapı	30 Metre	1513230000	5.304,00 TL	1
HSS-HF 1.2-2.4 EL W30M	0.25 - 0.5 mm ² kablo çapı	30 Metre	1513240000	1.120,00 TL	1
HSS-HF 1.6-3.2 EL W30M	0.5 - 1.5 mm ² kablo çapı	30 Metre	1513250000	1.188,00 TL	1
HSS-HF 2.4-4.8 EL W30M	0.75 - 4 mm ² kablo çapı	30 Metre	1513270000	1.380,00 TL	1
HSS-HF 3.2-6.4 EL W30M	1.5 - 6 mm ² kablo çapı	30 Metre	1513280000	1.676,00 TL	1
HSS-HF 4.8-9.5 EL W30M	4.00 - 16 mm ² kablo çapı	30 Metre	1513290000	2.290,00 TL	1
HSS-HF 6.4-12.7 EL W30M	6 - 35 mm ² kablo çapı	30 Metre	1513300000	2.632,00 TL	1
HSS-HF 9.5-19.1 EL W30M	16 - 70 mm ² kablo çapı	30 Metre	1513320000	3.744,00 TL	1
HSS-HF 12.7-25.4 EL W30M	35 - 120 mm ² kablo çapı	30 Metre	1513330000	5.304,00 TL	1

Not: 30m'lik Isıyla Daralan Makaronlar İçin Taşiyıcı Aparat Kullanılması Önerilir.

Tip	Renk	Ölçü / Adet	Sipariş No	Fiyat/Birim	Ambalaj
Cihaz Etiketleri					
LM MT300 15/6 WS	Beyaz	15,2x6 mm / 484 Adet	1686361044	132,70 TL	10
LM MT300 15/6 GE	Sarı	15,2x6 mm / 484 Adet	1686361687	132,70 TL	10
LM MT300 15/6 SI	Gümüş	15,2x6 mm / 484 Adet	1686360001	132,70 TL	10
LM MT300 17/9 WS	Beyaz	17,8x9 mm / 341 Adet	1724151044	132,70 TL	10
LM MT300 17/9 GE	Sarı	17,8x9 mm / 341 Adet	1724151687	132,70 TL	10

Serinin devamı sayfa 47

Tip	Renk	Ölçü / Adet	Sipariş No	Fiyat/Birim	Ambalaj
LM MT300 17/9 SI	Gümüş	17,8x9 mm / 341 Adet	1724150001	132,70 TL	10
LM MT300 20/8 WS	Beyaz	20,3x8 mm / 264 Adet	1686381044	132,70 TL	10
LM MT300 20/8 GE	Sarı	20,3x8 mm / 264 Adet	1686381687	132,70 TL	10
LM MT300 20/8 SI	Gümüş	20,3x8 mm / 264 Adet	1686380001	132,70 TL	10
LM MT300 26/10 WS	Beyaz	26,0x10 mm / 156 Adet	1686401044	132,70 TL	10
LM MT300 26/10 GE	Sarı	26,0x10 mm / 156 Adet	1686401687	132,70 TL	10
LM MT300 26/10 SI	Gümüş	26,0x10 mm / 156 Adet	1686400001	132,70 TL	10
LM MT300 56/22 WS	Beyaz	56,0x22 mm / 36 Adet	1686421044	132,70 TL	10
LM MT300 56/22 GE	Sarı	56,0x22 mm / 36 Adet	1686421687	132,70 TL	10
LM MT300 56/22 SI	Gümüş	56,0x22 mm / 36 Adet	1686420001	132,70 TL	10

Tip	Renk	Tabaka/Adet	Sipariş No	Fiyat/Birim	Ambalaj
Cihaz Etiketleri (Tekstil Tip Örme Yüzeyler)					
TABPACK 14X9	Sarı	Sayfa başına 840 adet	1686110000	371,90 TL	1
TABPACK 15X6	Sarı	Sayfa başına 1000 adet	1686120000	375,60 TL	1
TABPACK 19X11 M. RAND	Sarı	Sayfa başına 440 adet	1686130000	375,60 TL	1
TABPACK 21X8	Sarı	Sayfa başına 640 adet	1686140000	375,60 TL	1
TABPACK 38X11 M. RAND	Sarı	Sayfa başı 22 adet	1686150000	373,00 TL	1
PAGETAB 15/9	Sarı A4 Formatı	Sayfa başı 310 adet	1686160000	114,00 TL	25
PAGETAB 19/11	Sarı A4 Formatı	Sayfa başı 200 adet	1686170000	114,00 TL	25
PAGETAB 20/8	Sarı A4 Formatı	Sayfa başı 280 adet	1686180000	115,20 TL	25
PAGETAB 28/11	Sarı A4 Formatı	Sayfa başı 125 adet	1686190000	115,20 TL	25
PAGETAB 38/11	Sarı A4 Formatı	Sayfa başı 100 adet	1686200000	115,20 TL	25
PAGETAB 56/22	Sarı A4 Formatı	Sayfa başı 24 adet	1686210000	112,70 TL	25

Tip	Çap	Ölçü / Renk / Adet	Sipariş No	Fiyat/Birim	Ambalaj
WriteOn - Kablo ve İletken Markalaması					
LM WO 15/70 WS	8,2 - 14,3 mm	15 x 30 mm / Beyaz / 30 Adet	1759871044	218,65 TL	10
LM WO 15/140 WS	16,2 - 36,4 mm	15 x 70 mm / Beyaz / 26 Adet	1773880000	171,55 TL	10
LM WO 18/34 WS	5,0 - 7,0 mm	18 x 12,7 mm / Beyaz / 88 Adet	1695711044	159,05 TL	10
LM WO 18/34 GE	5,0 - 7,0 mm	18 x 12,7 mm / Sarı / 88 Adet	1695711687	159,05 TL	10
LM WO 23/55 WS	6,8 - 12,0 mm	23 x 12,7 mm / Beyaz / 40 Adet	1695721044	200,50 TL	10
LM WO 23/55 GE	6,8 - 12,0 mm	23 x 12,7 mm / Sarı / 40 Adet	1695721687	200,50 TL	10
LM WO 25/68 WS	8,2 - 14,3 mm	25 x 17 mm / Beyaz / 28 Adet	1695731044	159,05 TL	10
LM WO 25/68 GE	8,2 - 14,3 mm	25 x 17 mm / Sarı / 28 Adet	1695731687	159,05 TL	10
LM WO 25/140 WS	16,2 x 36,4 mm	25 x 26 mm / Beyaz / 16 Adet	1712491044	159,05 TL	10
LM WO 25/140 GE	16,2 x 36,4 mm	25 x 26 mm / Sarı / 16 Adet	1712491687	159,05 TL	10
LM WO 36/93 WS	9,5 - 22,3 mm	36 x 25 mm / Beyaz / 15 Adet	1695741044	200,50 TL	10
LM WO 36/93 GE	9,5 - 22,3 mm	36 x 25 mm / Sarı / 15 Adet	1695741687	200,50 TL	10



TABPACK 14X9



LM WO 15/70 WS

PCB - Baskılı Devre Klemensleri



SL 3.50/02/90 3.2SN OR BX



SL 3.50/02/180 3.2SN OR BX



BL 3.50/02/180 SN OR BX



BLZP 5.08HC/02/180 SN OR BX

Tip	V / A	Açıklama	Sipariş No	Fiyat/Birim	Ambalaj
OMNIMATE Baskılı Devre Fiş/Soket Konnektörleri: SL/BL Sistemi. Pin Aralığı: 3,50 mm					
Yatay Fiş					
SL 3.50/02/90 3.2SN OR BX	250 / 17	2 Kutup	1597210000	4,14 TL	100
SL 3.50/03/90 3.2SN OR BX	250 / 17	3 Kutup	1597220000	6,66 TL	100
SL 3.50/04/90 3.2SN OR BX	250 / 17	4 Kutup	1597230000	8,34 TL	100
SL 3.50/05/90 3.2SN OR BX	250 / 17	5Kutup	1597240000	10,85 TL	50
SL 3.50/06/90 3.2SN OR BX	250 / 17	6 Kutup	1597250000	13,00 TL	50
SL 3.50/07/90 3.2SN OR BX	250 / 17	7 Kutup	1597260000	14,75 TL	50
SL 3.50/08/90 3.2SN OR BX	250 / 17	8 Kutup	1597270000	17,35 TL	50
SL 3.50/09/90 3.2SN OR BX	250 / 17	9 Kutup	1597280000	19,20 TL	50
SL 3.50/10/90 3.2SN OR BX	250 / 17	10 Kutup	1597290000	21,85 TL	50
SL 3.50/11/90 3.2SN OR BX	250 / 17	11 Kutup	1597300000	23,75 TL	50
SL 3.50/12/90 3.2SN OR BX	250 / 17	12 Kutup	1597310000	25,70 TL	50
Dikey Fiş					
SL 3.50/02/180 3.2SN OR BX	250 / 17	2 Kutup	1604770000	4,14 TL	100
SL 3.50/03/180 3.2SN OR BX	250 / 17	3 Kutup	1604780000	6,66 TL	100
SL 3.50/04/180 3.2SN OR BX	250 / 17	4 Kutup	1604790000	8,34 TL	100
SL 3.50/05/180 3.2SN OR BX	250 / 17	5Kutup	1604800000	10,85 TL	50
SL 3.50/06/180 3.2SN OR BX	250 / 17	6 Kutup	1604810000	13,00 TL	50
SL 3.50/07/180 3.2SN OR BX	250 / 17	7 Kutup	1604820000	14,75 TL	50
SL 3.50/08/180 3.2SN OR BX	250 / 17	8 Kutup	1604830000	17,35 TL	50
SL 3.50/09/180 3.2SN OR BX	250 / 17	9 Kutup	1604840000	19,20 TL	50
SL 3.50/10/180 3.2SN OR BX	250 / 17	10 Kutup	1604850000	21,85 TL	50
SL 3.50/11/180 3.2SN OR BX	250 / 17	11 Kutup	1604860000	23,75 TL	50
SL 3.50/12/180 3.2SN OR BX	250 / 17	12 Kutup	1604870000	25,70 TL	50
Soket					
BL 3.50/02/180 SN OR BX	250 / 12	2 Kutup	1597360000	11,35 TL	264
BL 3.50/03/180 SN OR BX	250 / 12	3 Kutup	1597370000	17,35 TL	174
BL 3.50/04/180 SN OR BX	250 / 12	4 Kutup	1597380000	22,40 TL	132
BL 3.50/05/180 SN OR BX	250 / 12	5Kutup	1597390000	29,00 TL	102
BL 3.50/06/180 SN OR BX	250 / 12	6 Kutup	1597400000	34,75 TL	84
BL 3.50/07/180 SN OR BX	250 / 12	7 Kutup	1597410000	40,45 TL	72
BL 3.50/08/180 SN OR BX	250 / 12	8 Kutup	1597420000	45,60 TL	66
BL 3.50/09/180 SN OR BX	250 / 12	9 Kutup	1597430000	51,35 TL	54
BL 3.50/10/180 SN OR BX	250 / 12	10 Kutup	1597440000	57,10 TL	48
BL 3.50/11/180 SN OR BX	250 / 12	11 Kutup	1597450000	63,60 TL	48
BL 3.50/12/180 SN OR BX	250 / 12	12 Kutup	1597460000	69,30 TL	42
OMNIMATE Baskılı Devre Fiş/Soket Konnektörleri: SL/BL Sistemi. Pin Aralığı: 5,08 mm					
Yatay Soket (Vidalı Bağlantı)					
BLZP 5.08HC/02/180 SN OR BX	400 / 19	2 Kutup	1943580000	10,25 TL	180
BLZP 5.08HC/03/180 SN OR BX	400 / 19	3 Kutup	1943590000	15,35 TL	120
BLZP 5.08HC/04/180 SN OR BX	400 / 19	4 Kutup	1943600000	20,60 TL	90
BLZP 5.08HC/05/180 SN OR BX	400 / 19	5Kutup	1943610000	25,70 TL	72
BLZP 5.08HC/06/180 SN OR BX	400 / 19	6 Kutup	1943620000	30,85 TL	60
BLZP 5.08HC/07/180 SN OR BX	400 / 19	7 Kutup	1943630000	39,20 TL	48
BLZP 5.08HC/08/180 SN OR BX	400 / 19	8 Kutup	1943640000	41,20 TL	42
BLZP 5.08HC/09/180 SN OR BX	400 / 19	9 Kutup	1943650000	50,05 TL	36
BLZP 5.08HC/10/180 SN OR BX	400 / 19	10 Kutup	1943660000	55,20 TL	36
BLZP 5.08HC/11/180 SN OR BX	400 / 19	11 Kutup	1943670000	60,95 TL	30
BLZP 5.08HC/12/180 SN OR BX	400 / 19	12 Kutup	1943680000	66,85 TL	30



BLF 5.08HC/02/180 SN OR BX



SLA 02/90 3.2SN OR BX



SLA 02/180 3.2SN OR BX



SLAD 04/90 3.2SN OR



BLA 2 SN OR

Tip	V / A	Açıklama	Sipariş No	Fiyat/Birim	Ambalaj
Yatay Soket (Yaylı Bağlantı)					
BLF 5.08HC/02/180 SN OR BX	400 / 24	2 Kutup	1013680000	10,00 TL	180
BLF 5.08HC/03/180 SN OR BX	400 / 24	3 Kutup	1013690000	15,10 TL	120
BLF 5.08HC/04/180 SN OR BX	400 / 24	4 Kutup	1013710000	20,00 TL	90
BLF 5.08HC/05/180 SN OR BX	400 / 24	5Kutup	1013720000	25,10 TL	72
BLF 5.08HC/06/180 SN OR BX	400 / 24	6 Kutup	1013730000	30,10 TL	60
BLF 5.08HC/07/180 SN OR BX	400 / 24	7 Kutup	1013740000	35,40 TL	48
BLF 5.08HC/08/180 SN OR BX	400 / 24	8 Kutup	1013750000	40,45 TL	42
BLF 5.08HC/09/180 SN OR BX	400 / 24	9 Kutup	1013760000	45,60 TL	36
BLF 5.08HC/10/180 SN OR BX	400 / 24	10 Kutup	1013770000	50,05 TL	36
BLF 5.08HC/11/180 SN OR BX	400 / 24	11 Kutup	1013780000	55,20 TL	30
BLF 5.08HC/12/180 SN OR BX	400 / 24	12 Kutup	1013790000	60,40 TL	30
Yatay Fiş					
SLA 02/90 3.2SN OR BX	400 / 17,5	2 Kutup	1238060000	4,68 TL	100
SLA 03/90 3.2SN OR BX	400 / 17,5	3 Kutup	1238160000	7,26 TL	100
SLA 04/90 3.2SN OR BX	400 / 17,5	4 Kutup	1238260000	7,46 TL	100
SLA 05/90 3.2SN OR BX	400 / 17,5	5Kutup	1238360000	9,29 TL	50
SLA 06/90 3.2SN OR BX	400 / 17,5	6 Kutup	1238460000	13,20 TL	50
SLA 07/90 3.2SN OR BX	400 / 17,5	7 Kutup	1238560000	14,75 TL	50
SLA 08/90 3.2SN OR BX	400 / 17,5	8 Kutup	1238660000	17,60 TL	50
SLA 09/90 3.2SN OR BX	400 / 17,5	9 Kutup	1238760000	16,80 TL	50
SLA 10/90 3.2SN OR BX	400 / 17,5	10 Kutup	1238860000	22,00 TL	50
SLA 11/90 3.2SN OR BX	400 / 17,5	11 Kutup	1238960000	20,45 TL	50
SLA 12/90 3.2SN OR BX	400 / 17,5	12 Kutup	1239060000	22,30 TL	50
Dikey Fiş					
SLA 02/180 3.2SN OR BX	400 / 17,5	2 Kutup	1239560000	3,60 TL	100
SLA 03/180 3.2SN OR BX	400 / 17,5	3 Kutup	1239660000	5,52 TL	100
SLA 04/180 3.2SN OR BX	400 / 17,5	4 Kutup	1239760000	8,80 TL	100
SLA 05/180 3.2SN OR BX	400 / 17,5	5Kutup	1239860000	11,40 TL	50
SLA 06/180 3.2SN OR BX	400 / 17,5	6 Kutup	1239960000	13,20 TL	50
SLA 07/180 3.2SN OR BX	400 / 17,5	7 Kutup	1240060000	14,75 TL	50
SLA 08/180 3.2SN OR BX	400 / 17,5	8 Kutup	1240160000	17,60 TL	50
SLA 09/180 3.2SN OR BX	400 / 17,5	9 Kutup	1240260000	16,80 TL	50
SLA 10/180 3.2SN OR BX	400 / 17,5	10 Kutup	1240360000	18,65 TL	50
SLA 11/180 3.2SN OR BX	400 / 17,5	11 Kutup	1240460000	20,45 TL	50
SLA 12/180 3.2SN OR BX	400 / 17,5	12 Kutup	1240560000	22,30 TL	50
Yatay Fiş - İki Katlı					
SLAD 04/90 3.2SN OR	400 / 10	4 Kutup	1320060000	12,70 TL	50
SLAD 06/90 3.2SN OR	400 / 10	6 Kutup	1320160000	19,20 TL	50
SLAD 08/90 3.2SN OR	400 / 10	8 Kutup	1372460000	25,30 TL	50
SLAD 12/06/90 3.2SN OR	400 / 10	12 Kutup	1372660000	38,05 TL	50
Soket					
BLA 2 SN OR	400 / 17,5	2 Kutup	1281760000	10,85 TL	180
BLA 3 SN OR	400 / 17,5	3 Kutup	1281860000	16,15 TL	120
BLA 4 SN OR	400 / 17,5	4 Kutup	1281960000	28,00 TL	90
BLA 5 SN OR	400 / 17,5	5Kutup	1282060000	29,60 TL	72
BLA 6 SN OR	400 / 17,5	6 Kutup	1282160000	42,00 TL	60
BLA 7 SN OR	400 / 17,5	7 Kutup	1282260000	49,00 TL	48
BLA 8 SN OR	400 / 17,5	8 Kutup	1282360000	56,00 TL	42
BLA 9 SN OR	400 / 17,5	9 Kutup	1282460000	53,75 TL	36
BLA 10 SN OR	400 / 17,5	10 Kutup	1282560000	70,00 TL	36

Serinin devamı sayfa 50

PCB - Baskılı Devre Klemensleri



PS 3.50/02/90 3.5SN BK BX



LS 5.08/02/90 3.5SN BK BX



LPP 5.08/02/90 3.2SN OR BX



LSF-SMT 5.08/02/180 3.5SN BK TU

Tip	V / A	Açıklama	Sipariş No	Fiyat/Birim	Ambalaj
BLA 11 SN OR	400 / 17,5	11 Kutup	1282660000	69,90 TL	30
BLA 12 SN OR	400 / 17,5	12 Kutup	1282760000	73,90 TL	30
PS Sistemi. Pin Aralığı: 3,50 mm - Pin Uzunluk 3,50 mm					
PS 3.50/02/90 3.5SN BK BX	320 / 17,5	2 Kutup	1811180000	3,36 TL	100
PS 3.50/03/90 3.5SN BK BX	320 / 17,5	3 Kutup	1811190000	4,86 TL	100
PM Sistemi. Pin Aralığı: 5,08 mm - Pin Uzunluk 3,50 mm					
PM 5.08/02/90 3.5SN OR BX	600 / 24	2 Kutup	1760490000	2,36 TL	500
PM 5.08/03/90 3.5SN OR BX	600 / 24	3 Kutup	1760500000	3,42 TL	500
LS Sistemi. Pin Aralığı: 5,08 mm - Pin Uzunluk 3,50 mm					
LS 5.08/02/90 3.5SN BK BX	600 / 24	2 Kutup	1810850000	4,14 TL	100
LS 5.08/03/90 3.5SN BK BX	600 / 24	3 Kutup	1810860000	6,30 TL	100
LM Sistemi. Pin Aralığı: 5,08 mm - Pin Uzunluk 3,50 mm					
LM 5.08/02/90 3.5SN OR BX	600 / 17,5	2 Kutup	1716080000	4,44 TL	500
LM 5.08/03/90 3.5SN OR BX	600 / 17,5	3 Kutup	1716090000	6,66 TL	500
LP Sistemi. Pin Aralığı: 5,08 mm - Pin Uzunluk 3,20 mm					
LPP 5.08/02/90 3.2SN OR BX	500 / 32	2 Kutup	1594400000	8,34 TL	100
LPP 5.08/03/90 3.2SN OR BX	500 / 32	3 Kutup	1594410000	12,65 TL	100
LSF Sistemi. Pin Aralığı: 5,08 mm - Pin Uzunluk 3,50 mm					
LSF-SMT 5.08/02/90 3.5SN BK TU	500 / 17,5	2 Kutup	1824810000	4,86 TL	59
LSF-SMT 5.08/03/90 3.5SN BK TU	500 / 17,5	3 Kutup	1824820000	7,20 TL	38
LSF Sistemi. Pin Aralığı: 5,08 mm - Pin Uzunluk 3,50 mm (THR Reflow Lehimleme)					
LSF-SMT 5.08/02/180 3.5SN BK TU	500 / 17,5	2 Kutup	1826040000	4,86 TL	59
LSF-SMT 5.08/03/180 3.5SN BK TU	500 / 17,5	3 Kutup	1826060000	7,20 TL	38
SMD Sistemi					
LSF-SMD 3.50/02/180 SN BK RL	500 / 17,5	2 Kutup	1250360000	13,80 TL	235
LSF-SMD 3.50/03/180 SN BK RL	500 / 17,5	3 Kutup	1250370000	17,35 TL	180
Tip	Açıklama	Sipariş No	Fiyat/Birim	Ambalaj	
Baskılı Devre Kartı, Raya Montaj Malzemeleri					
HP SKH	SKH İçin Tutucu Bara	0137100000	2,48 €	20	
SKH SAEULE PBTP20GV OR	Baskılı Devre Kızağı	0550160000	4,47 €	10	
RH 1 F.SKH 31 S	Baskılı Devre Mandalı	0587160000	25,08 TL	20	
RH 2 F.SKH 32-48	Baskılı Devre Mandalı	0632760000	28,32 TL	20	
FM 4/TS35	TS 35 Ray Adaptörü	0687900000	10,26 TL	40	
MB M6/M4 GR	TS 32 Ray Adaptörü	0334900000	11,52 TL	20	
RF RS 70 RE/A4/O.BEZ OR	Sağ Ayak	0126260000	25,08 TL	20	
RF RS 70 LI/A2/O.SG OR	Sol Ayak	0119660000	21,84 TL	20	
RF RS 70 MI/A6 OR	Orta Ayak	0213760000	21,84 TL	20	
ZW 5 RS OR	5 mm'lik Profil	0119760000	21,84 TL	20	
ZW 15 RS OR	15 mm'lik Profil	0119860000	25,08 TL	20	
ZW 25 RS OR	25 mm'lik Profil	0126160000	25,08 TL	20	
ZW 30 RS OR	30 mm'lik Profil	0119960000	26,28 TL	20	
ZW 45 RS OR	45 mm'lik Profil	0120060000	27,66 TL	20	
PF RS 80 OR 2000MM	84 mm'lik Profil (2m)	4157440000	240,25 TL	2M	
RF 180 OR	Montaj Ayağı	1324460000	21,85 TL	20	
AP 80 OR	Nihayet Plakası	1324260000	19,20 TL	20	
PF RS 100 OR 2000MM A.1	Profil 104 mm (2m)	4144870000	301,90 TL	2M	
AP 100 OR	Nihayet Plakası	1185060000	25,10 TL	20	
Baskılı Devre Kızağı (Komple)					
SKH D32 LP 5/16 RH2	Baskılı Devre Kızağı	0586761001	70,00 €	1	
SKH 31 LP 250VAC RH1	Baskılı Devre Kızağı	0648661001	70,00 €	1	

RockStar® - Sanayi Tipi Fiş - Soketlerde Yeni Boyut

Ağır çevre koşulları altında güvenli ve modüler bağlantı gerektiren, makina ve diğer elektrik bağlantılarında kullanılır. Çok dayanıklı alüminyum dökümden imal edilen kutular rutubet, kirli ortam ve mekanik darbe gibi çevresel koşullarda mükemmel bir koruma sağlar.

Özel modüler klemens kombinasyonları, enerji iletimini pnomatik ve data sinyalleri ile tek bir kutuda birleştirebilir.

Weidmüller patentli kilitleme mekanizması ile RockStar® ağır şartlar için ihtiyaç duyulan çok çeşitli bağlantıları içerir. Ürün yelpazemiz ile çeşitli uygulama ihtiyaçlarınıza tam olarak cevap vererek ürünlerinizin kalitesini üst seviyeye taşır.

Rockstar ihtiyacınıza uygun ürünü bulmanızı kolaylaştırarak zaman ve maliyet avantajı sağlar. Üretim şeklinizi optimumlaştırarak pazar pozisyonunuzu kuvvetlendirir. Böylece faaliyet gösterdiğiniz pazarda rakiplerinize karşı avantajlar sağlarsınız.

RockStar® Sanayi Tipi Fiş - Soket Kitleri — Kolay Seçim İçin

RockStar® Kit'leri kendinizin monte edebileceği parçalardan oluşur. Tüm gerekli parçaları içinde bulunduran Kit'ler sanayi tipi fiş soketleri tek bir sipariş numarasında bir araya getirir. RockStar® Kit'ler, fiş soketler, pinler, fiş kutuları, priz kutuları ve kablo rakorlarını içerirler.

Avantajları:

- Kolay seçim
- Kolay tasarım
- Kolay depolama

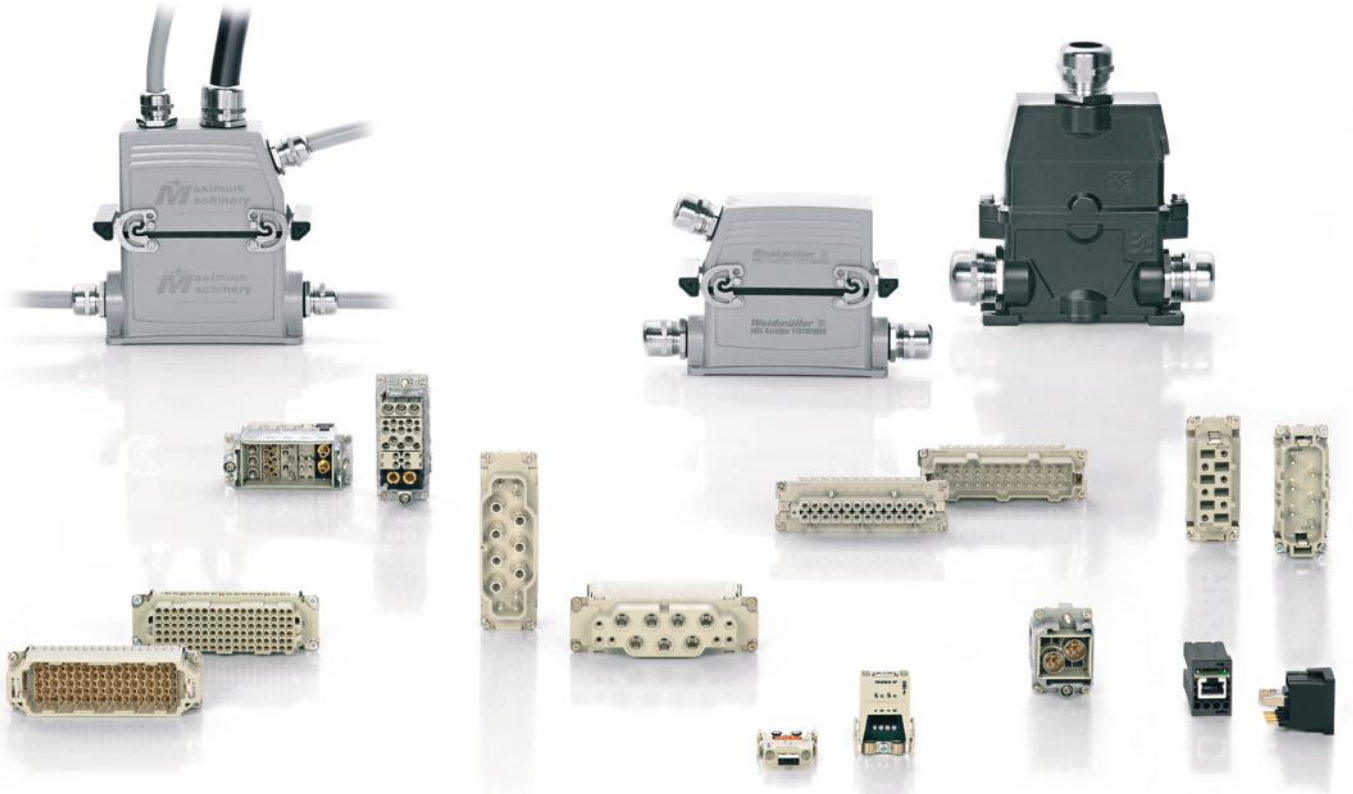



HDC-KIT-HE 10.111



HDC HE 6 MS



HDC HE 6 MT



HDC HE 10 MS



HDC 10B TOBU 1PG16G



HDC 10B TSBU 1PG16G



HDC HE 16 MS

Tip	V / A	Kutup Sayısı	Sipariş No	Fiyat/Birim	Ambalaj
HE Serisi Komple Sanayi Tipi Fiş-Soketler (Kit'ler)					
Yukardan Rakorlu					
HDC-KIT-HA 03.300	500 V / 24 A	3-kutup(Metal Kutu)	1712560000	242,15 TL	1
HDC-KIT-HA 03.301	250 V / 22 A	3-kutup(Plastik Kutu)	1712570000	302,50 TL	1
HDC-KIT-HA 04.400	250 V / 22 A	4-kutup(Metal Kutu)	1712590000	255,50 TL	1
HDC-KIT-HA 04.401	250 V / 22 A	4-kutup(Plastik Kutu)	1712600000	252,60 TL	1
HDC-KIT-HE 06.101	500 V / 24 A	6-kutup(Metal Kutu)	1712660000	453,70 TL	1
HDC-KIT-HE 10.111	500 V / 16 A	10-kutup(Metal Kutu)	1712670000	577,00 TL	1
HDC-KIT-HE 16.121	500 V / 16 A	16-kutup(Metal Kutu)	1712680000	656,00 TL	1
HDC-KIT-HE 24.131	500 V / 16 A	24-kutup(Metal Kutu)	1712690000	695,00 TL	1
Yandan Rakorlu					
HDC-KIT-HE 06.100	500 V / 24 A	6-kutup(Metal Kutu)	1712460000	383,60 TL	1
HDC-KIT-HE 10.110	500 V / 16 A	10-kutup(Metal Kutu)	1712510000	517,00 TL	1
HDC-KIT-HE 16.120	500 V / 16 A	16-kutup(Metal Kutu)	1712520000	659,00 TL	1
HDC-KIT-HE 24.130	500 V / 16 A	24-kutup(Metal Kutu)	1712530000	717,00 TL	1
HDC-KIT-HE 32.140	400 V / 16 A	32-kutup(Metal Kutu)	1712540000	1.361,00 TL	1
HDC-KIT-HE 48.150	500 V / 16 A	48-kutup(Metal Kutu)	1712550000	1.898,00 TL	1
HE - Tipi Fiş-Soketler (Vidalı / yaylı bağlantı) / Universal Konnektörler					
6 Kutup					
HDC HE 6 MS	500 V / 24 A	6 kutup (Fiş)	1200000000	80,10 TL	1
HDC HE 6 FS	500 V / 24 A	6 kutup (Soket)	1200200000	80,10 TL	1
HDC HE 6 MT	500 V / 24 A	6 kutup (Fiş)	1745820000	80,10 TL	1
HDC HE 6 FT	500 V / 24 A	6 kutup (Soket)	1745760000	80,10 TL	1
HDC 06B TOLU 1PG16G		Yukarıdan Rakorlu	1652640000	98,00 TL	1
HDC 06B TSLU 1PG16G		Yandan Rakorlu	1652520000	98,00 TL	1
HDC 06B ALU		Makina Tipi	1202100000	93,55 TL	1
HDC 06B ALU N		Makina Tipi	2488560000	103,00 TL	1
HDC 06B SLU 1PG16G		Duvar Tipi	1652750000	145,80 TL	1
HDC 06B KLU 1PG16G		Seyyar Tip	1653200000	193,55 TL	1
HDC 06B DODL 2B0		Koruma Kapağı	1665200000	150,60 TL	1
10 Kutup					
HDC HE 10 MS	500 V / 16 A	10 kutup (Fiş)	1203900000	80,10 TL	1
HDC HE 10 FS	500 V / 16 A	10 kutup (Soket)	1204100000	80,10 TL	1
HDC HE 10 MT	500 V / 16 A	10 kutup (Fiş)	1745830000	106,35 TL	1
HDC HE 10 FT	500 V / 16 A	10 kutup (Soket)	1745770000	106,35 TL	1
HDC 10B TOBU 1PG16G		Yukarıdan Rakorlu	1654220000	138,20 TL	1
HDC 10B TSBU 1PG16G		Yandan Rakorlu	1654070000	138,20 TL	1
HDC 10B ABU		Makina Tipi	1205000000	142,60 TL	1
HDC 10B ABU N		Makina Tipi	2488580000	149,00 TL	1
HDC 10B SBU 1PG16G		Duvar Tipi	1654370000	219,65 TL	1
HDC 10B KBU 1PG16G		Seyyar Tip	1654580000	179,05 TL	1
HDC 10B DODQ 4B0		Koruma Kapağı	1665230000	133,50 TL	1
16 Kutup					
HDC HE 16 MS	500 V / 16 A	16 kutup (Fiş)	1207500000	119,75 TL	1
HDC HE 16 FS	500 V / 16 A	16 kutup (Soket)	1207700000	119,75 TL	1
HDC HE 16 MT	500 V / 16 A	16 kutup (Fiş)	1745840000	140,85 TL	1
HDC HE 16 FT	500 V / 16 A	16 kutup (Soket)	1745780000	140,85 TL	1
HDC 16B TOBU 1PG21G		Yukarıdan Rakorlu	1656590000	145,80 TL	1
HDC 16B TSBU 1PG21G		Yandan Rakorlu	1656480000	142,60 TL	1
HDC 16B ABU		Makina Tipi	1208600000	142,60 TL	1

Serinin devamı sayfa 53



HDC HE 24 MS



HDC HE 24 MT



HDC HE 16 MS



HDC 32B TOBU 1PG29G



HDC HDD 24 MC



HDC-C-HD-SM0.75-1.00AG

Tip	V / A	Kutup Sayısı	Sipariş No	Fiyat/Birim	Ambalaj
HDC 16B ABU N		Makina Tipi	2488590000	155,05 TL	1
HDC 16B SBU 1PG21G		Duvar Tipi	1656720000	231,00 TL	1
HDC 16B KBU 1PG21G		Seyyar Tip	1657270000	191,00 TL	1
HDC 16B DODQ 4B0		Koruma Kapağı	1665260000	167,00 TL	1

24 Kutup

HDC HE 24 MS	500 V / 16 A	24 kutup (Fiş)	1211100000	170,95 TL	1
HDC HE 24 FS	500 V / 16 A	24 kutup (Soket)	1211300000	170,95 TL	1
HDC HE 24 MT	500 V / 16 A	24 kutup (Fiş)	1745850000	170,95 TL	1
HDC HE 24 FT	500 V / 16 A	24 kutup (Soket)	1745790000	170,95 TL	1
HDC 24B TOBU 1PG21G		Yukarıdan Rakorlu	1661370000	156,05 TL	1
HDC 24B TSBV 1PG21G		Yandan Rakorlu	1661230000	156,05 TL	1
HDC 24B ABU		Makina Tipi	1212400000	161,10 TL	1
HDC 24B ABU N		Makina Tipi	2488600000	165,40 TL	1
HDC 24B SBU 1PG21G		Duvar Tipi	1661510000	264,75 TL	1
HDC 24B KBU 1PG21G		Seyyar Tip	1661720000	230,95 TL	1
HDC 24B DODQ 4B0		Koruma Kapağı	1665630000	205,45 TL	1

32 Kutup

HDC HE 16 MS	500 V / 16 A	16 kutup (Fiş)	1207500000	119,75 TL	1
HDC HE 16 MS 17-32	500 V / 16 A	32 kutup (Fiş)	1215700000	130,15 TL	1
HDC HE 16 FS	500 V / 16 A	16 kutup (Soket)	1207700000	119,75 TL	1
HDC HE 16 FS 17-32	500 V / 16 A	32 kutup (Soket)	1216100000	133,30 TL	1
HDC HE 16 MT	500 V / 16 A	16 kutup (Fiş)	1745840000	140,85 TL	1
HDC HE 16 MT 17-32	500 V / 16 A	32 kutup (Fiş)	1745860000	134,50 TL	1
HDC HE 16 FT	500 V / 16 A	16 kutup (Soket)	1745780000	140,85 TL	1
HDC HE 16 FT 17-32	500 V / 16 A	32 kutup (Soket)	1745800000	134,50 TL	1
HDC 32B TOBU 1PG29G		Yukarıdan Rakorlu	1666870000	387,05 TL	1
HDC 32B TSBV 1PG29G		Yandan Rakorlu	1666840000	396,50 TL	1
HDC 32B ABU		Makina Tipi	1217800000	318,95 TL	1
HDC 32B SBU 2PG29G		Duvar Tipi	1666920000	438,10 TL	1
HDC 32B KBU 1PG29G		Seyyar Tip	1902740000	619,00 TL	1

HDD Serisi (Çoklu Crimp Bağlantı)**24 Kutup**

HDC HDD 24 MC	250 V / 10 A	24 kutup (Fiş)	1651150000	165,50 TL	1
HDC HDD 24 FC	250 V / 10 A	24 kutup (Soket)	1651160000	164,95 TL	1
HDC 06B TOLU 1PG16G		Yukarıdan Rakorlu	1652640000	98,00 TL	1
HDC 06B TSLU 1PG16G		Yandan Rakorlu	1652520000	98,00 TL	1
HDC 06B ALU		Makina Tipi	1202100000	93,55 TL	1
HDC 06B ALU N		Makina Tipi	2488560000	103,00 TL	1
HDC 06B SLU 1PG16G		Duvar Tipi	1652750000	145,80 TL	1
HDC 06B KLU 1PG16G		Seyyar Tip	1653200000	193,55 TL	1

Tip	Açıklama	Sipariş No	Fiyat/Birim	Ambalaj
-----	----------	------------	-------------	---------

HDD Serisi (Çoklu Crimp Bağlantı)**Aksesuarlar**

HDC-C-HD-SM0.75-1.00AG	0.75- 1.00 kablo kesiti / Erkek	1601750000	7,50 TL	100
HDC-C-HD-SM1.5AG	1.5 kablo kesiti / Erkek	1651550000	7,50 TL	100



HDC HDD 42 MC



HDC 10B TOBU 1PG16G



HDC 10B TSBU 1PG16G



HDC HDD 72 MC



HDC HDD 108 MC



CTX CM 1.6/2.5

Tip	V / A	Kutup Sayısı	Sipariş No	Fiyat/Birim	Ambalaj
HDD Serisi (Çoklu Crimp Bağlantı)					
42 Kutup					
HDC HDD 42 MC	250 V / 10 A	42 kutup Fiş	1651170000	181,75 TL	1
HDC HDD 42 FC	250 V / 10 A	42 kutup Soket	1651180000	181,75 TL	1
HDC 10B TOBU 1PG16G		Yukarıdan Rakorlu	1654220000	138,20 TL	1
HDC 10B TSBU 1PG16G		Yandan Rakorlu	1654070000	138,20 TL	1
HDC 10B ABU		Makina Tipi	1205000000	142,60 TL	1
HDC 10B ABU N		Makina Tipi	2488580000	149,00 TL	1
HDC 10B SBU 1PG16G		Duvar Tipi	1654370000	219,65 TL	1
HDC 10B KBU 1PG16G		Seyyar Tip	1654580000	179,05 TL	1

Tip	Açıklama	Sipariş No	Fiyat/Birim	Ambalaj
HDD Serisi (Çoklu Crimp Bağlantı)				
Aksesuarlar				
HDC-C-HD-BM1.5AG	1.5 kablo kesiti / Dişi	1651600000	7,50 TL	100
HDC-C-HD-BM2.5AG	2.5 kablo kesiti / Dişi	1651610000	7,50 TL	100

Tip	V / A	Açıklama	Sipariş No	Fiyat/Birim	Ambalaj
HDD Serisi (Çoklu Crimp Bağlantı)					
72 Kutup					
HDC HDD 72 MC	250 V / 10 A	72 Kutup fiş	1651190000	187,60 TL	1
HDC HDD 72 FC	250 V / 10 A	72 Kutup soket	1651200000	187,60 TL	1
HDC 16B TOBU 1PG21G		Yukarıdan Rakorlu	1656590000	145,80 TL	1
HDC 16B TSBU 1PG21G		Yandan Rakorlu	1656480000	142,60 TL	1
HDC 16B ABU		Makina Tipi	1208600000	142,60 TL	1
HDC 16B ABU N		Makina Tipi	2488590000	155,05 TL	1
HDC 16B SBU 1PG21G		Duvar Tipi	1656720000	231,00 TL	1
HDC 16B KBU 1PG21G		Seyyar Tip	1657270000	191,00 TL	1

Tip	Açıklama	Sipariş No	Fiyat/Birim	Ambalaj
HDD Serisi (Çoklu Crimp Bağlantı)				
Aksesuarlar				
HDC-C-HD-SM2.5AG	2.5 kablo kesiti / Erkek	1651560000	7,50 TL	100
REMOVAL TOOL HD	Sökme Aparatı	1866730000	658,00 TL	1

Tip	V / A	Açıklama	Sipariş No	Fiyat/Birim	Ambalaj
HDD Serisi (Çoklu Crimp Bağlantı)					
108 Kutup					
HDC HDD 108 MC	250 V / 10 A	108 Kutup fiş	1651210000	201,90 TL	1
HDC HDD 108 FC	250 V / 10 A	108 Kutup soket	1651220000	201,90 TL	1
HDC 24B TOBU 1PG21G		Yukarıdan Rakorlu	1661370000	156,05 TL	1
HDC 24B TSBU 1PG21G		Yandan Rakorlu	1661230000	156,05 TL	1
HDC 24B ABU		Makina Tipi	1212400000	161,10 TL	1
HDC 24B ABU N		Makina Tipi	2488600000	165,40 TL	1
HDC 24B SBU 1PG21G		Duvar Tipi	1661510000	264,75 TL	1
HDC 24B KBU 1PG21G		Seyyar Tip	1661720000	230,95 TL	1

Tip	Açıklama	Sipariş No	Fiyat/Birim	Ambalaj
HDD Serisi (Çoklu Crimp Bağlantı)				
Aksesuarlar				
HDC-C-HD-BM0.75-1.00AG	0.75- 1.00 kablo kesiti / Dişi	1601760000	7,50 TL	100
CTX CM 1.6/2.5	Crimp kontak sıkma el aleti / 0.14mm ² ... 4mm ²	9018490000	6.811,00 TL	1



HDC HSB 6 MS



HDC HSB 6 MS



HDC 32B TOBU 1PG29G



HDC IP68 HP 24B TO



HDC IP68 HP 24B A



STV S 2 SS

Tip	V / A	Kutup Sayısı	Sipariş No	Fiyat/Birim	Ambalaj
HSB - Tipi Güç Konnektörleri					
6 Kutup					
HDC HSB 6 MS	400 V / 35 A	6 kutup (Fiş)	1498700000	265,15 TL	1
HDC HSB 6 FS	400 V / 35 A	6 kutup (Soket)	1498900000	299,65 TL	1
HDC 16B TOBU 1PG21G		Yukarıdan Rakorlu	1656590000	145,80 TL	1
HDC 16B TSBU 1PG21G		Yandan Rakorlu	1656480000	142,60 TL	1
HDC 16B ABU		Makina Tipi	1208600000	142,60 TL	1
HDC 16B ABU N		Makina Tipi	2488590000	155,05 TL	1
HDC 16B SBU 1PG21G		Duvar Tipi	1656720000	231,00 TL	1
HDC 16B KBU 1PG21G		Seyyar Tip	1657270000	191,00 TL	1
12 Kutup					
HDC HSB 6 MS	400 V / 35 A	6 kutup (Fiş)	1498700000	265,15 TL	1
HDC HSB 6 MS 7 - 12	400 V / 35 A	12 kutup (Fiş)	1498800000	265,15 TL	1
HDC HSB 6 FS	400 V / 35 A	6 kutup (Soket)	1498900000	299,65 TL	1
HDC HSB 6 FS 7 - 12	400 V / 35 A	12 kutup (Soket)	1499000000	292,90 TL	1
HDC 32B TOBU 1PG29G		Yukarıdan Rakorlu	1666870000	387,05 TL	1
HDC 32B TSBU 1PG29G		Yandan Rakorlu	1666840000	396,50 TL	1
HDC 32B ABU		Makina Tipi	1217800000	318,95 TL	1
HDC 32B SBU 2PG29G		Duvar Tipi	1666920000	438,10 TL	1
HDC 32B KBU 1PG29G		Seyyar Tip	1902740000	619,00 TL	1

Tip	Açıklama	Sipariş No	Fiyat/Birim	Ambalaj
HDC - HP Tipi 250A / 550A GÜÇ KONNEKTÖRLERİ				
250 A / 4000 V				
HDC IP68 HP 24B TO	Fiş Koruma Kılıfı	1079930000	1.180,00 TL	1
HDC IP68 HP 24B AS S	Sabit Fiş Koruma Kılıfı	1079920000	1.690,00 TL	1
HDC IP68 HP 24B A	Makine Tipi	1120040000	605,00 TL	1
HDC IP68 24B HP FRAME	Çerçeve	1282820000	490,10 TL	1
550 A / 4000 V				
HDC IP68 HP 24B TO	Fiş Koruma Kılıfı	1079930000	1.180,00 TL	1
HDC IP68 HP 24B AS S	Sabit Fiş Koruma Kılıfı	1079920000	1.690,00 TL	1
HDC IP68 HP 24B A	Makine Tipi	1120040000	605,00 TL	1
HDC IP68 24B HP FRAME	Çerçeve	1282820000	490,10 TL	1
Aksesuarlar				
Crimp Contact		Sorunuz	Sorunuz	1
EMC-Shield Lever		Sorunuz	Sorunuz	1
Touch-Safe Protection Safe		Sorunuz	Sorunuz	1
Mounting Frame		Sorunuz	Sorunuz	1
Cable Glands		Sorunuz	Sorunuz	1

Fiş-Soket Klemensleri (STV S Tipi)				
STV S 2 SS	2 Kutuplu Fiş	1611950000	37,60 TL	10
STV S 2 SB	2 Kutuplu Soket	1611960000	47,05 TL	10
STV S 3 SS	3 Kutuplu Fiş	1611980000	41,40 TL	10
STV S 3 SB	3 Kutuplu Soket	1611990000	59,40 TL	10
STV S 4 SS	4 Kutuplu Fiş	1612010000	62,65 TL	10
STV S 4 SB	4 Kutuplu Soket	1612020000	79,50 TL	10
STV S 5 SS	5 Kutuplu Fiş	1612040000	94,55 TL	10
STV S 5 SB	5 Kutuplu Soket	1612050000	95,15 TL	10
STV S 6 SS	6 Kutuplu Fiş	1612070000	70,00 TL	10
STV S 6 SB	6 Kutuplu Soket	1612080000	102,10 TL	10
STV S 8 SS	8 Kutuplu Fiş	1612130000	92,75 TL	10

Serinin devamı sayfa 56

Tip	Açıklama	Sipariş No	Fiyat/Birim	Ambalaj
STV S 8 SB	8 Kutuplu Soket	1612140000	140,00 TL	10
STV S 9 SS	9 Kutuplu Fiş	1612160000	114,25 TL	10
STV S 9 SB	9 Kutuplu Soket	1612170000	141,10 TL	10
STV S 10 SS	10 Kutuplu Fiş	1612190000	98,95 TL	10
STV S 10 SB	10 Kutuplu Soket	1612200000	147,05 TL	10

Fiş-Soket Klemensleri (STV-STW Tipi)

STV 2/10 S/B	Komple	0644960000	258,60 TL	10
STV 2/10 LB 90 3.2	Lehim pinli, Soket	1305360000	176,50 TL	10
STV 2/10 LS 90 3.2	Lehim pinli, Fiş	1305760000	110,15 TL	10
STW 2/20/D S/B TS ZE	Raya monte edilebilir	1268360000	889,00 TL	5
STW 2/20/C S/B TS ZE	Raya monte edilebilir	0291660000	889,02 TL	5

Tip	Açıklama	SW1 / SW2	Sipariş No	Fiyat/Birim	Ambalaj
Plastik Rakorlar IP 67					
VG PG11-K67	PG 11	22	1909780000	9,84 TL	50
VG PG16-K67	PG 16	27	1909800000	11,15 TL	50
VG PG21-K67	PG 21	33	1909810000	10,80 TL	25
VG PG29-K67	PG 29	42	1909820000	23,30 TL	20

Metal Rakorlar IP 67					
VG 11-MS68	Kablo Rakoru-PG11-IP68	20	1569080000	40,75 TL	50
VG 16-MS68	Kablo Rakoru-PG16-IP68	24	1569100000	54,80 TL	25
VG 21-MS68	Kablo Rakoru-PG21-IP68	30	1569110000	90,95 TL	25
VG 29-MS68	Kablo Rakoru-PG29-IP68	40	1569120000	143,15 TL	10



VG PG11-K67

El Aletleri

Hidrolik Skp Pabuç Sıkma Ürünleri

Skp pabuç sıkma ailesinin yeni üyeleri tamamen hidrolik çalışma prensibi ile güç sarfiyatını en aza düşürüyor. Tüm kesit aralıklarında, farklı sıkma şekillerini destekleyen çene yapılarıyla beraber bakır ve alüminyum hem izoleli hem izolesiz pabuçlar için çözümler sunmaktadır. Manuel ve otomatik olarak her el aleti için iki farklı opsiyon bulunmaktadır.

Kesme

Weidmüller kesme aletleri profesyonel kablo işçiliğinin bütün kriterlerini yerine getirir. Tüm kesme aletleri için istenen iletken formunu bozmadan, düz ve pürüzsüz bir kesimdir. Her türlü iletken kesimi için gerekli el aletini Weidmüller ürün ailesi içerisinde bulabilirsiniz.

Kablo Soyma

Kablo soyma, iletkenin dış izolasyonunun sıyrılıp alınması anlamına gelir. Soyma esnasında şunlar garantilenmelidir: Soyma ölçüsü dikkate alınmalı ve iletkene zarar vermemelidir. Aynı şart geride kalan izolasyon için de geçerlidir.

Sıkma

İzolasyonu soyulan kablo ucuna yüksek pabuç yada özel bağlantı konnetörleri elektriksel ve mekaniksel kriterlere uygun olarak sıkıştırılır. Weidmüller sıkma aletleri kablo uçlarını sıkmak için çok geniş bir ürün ailesine sahiptir.

Klemens Tornavidaları

Tornavidaların sap yapısı, kullanıcının tutuş konforu göz önünde bulundurularak sürekli geliştirme sonunda özel olarak tasarlanmıştır. Çeşitli çalışma tarzlarına uygundur.

Test ve Ölçü Aletleri

Test ve ölçü aletleri elektrik tesislerinin yapım ve bakımı ve tamirinde büyük önem taşırlar. Weidmüller'in ürün ailesi ile standartlara uygun şekilde test ve ölçüm yapabilirsiniz.

Takım Çantaları

Elektrik, Elektronik ve otomasyon işçiliğinde kullanım için değişik ihtiyaçlara yönelik kombine edilmiş profesyonel el aletleri setlerinden oluşur.





KT 8



KT 55



TSLD 5



STRIPAX 16



AM 12



STRIPAX PLUS 2.5



HTF 63

Tip	Açıklama	Sipariş No	Fiyat/Birim	Ambalaj
Kablo Kesme				
KT 8	8 mm max. Çap/Örgü kesit:16mm ² /Çok Damarlı kesit:16mm ² /Tek Damarlı Kesit:16mm ²	9002650000	894,00 TL	1
KT 12	12 mm max. Çap/Örgü kesit:25mm ² /Çok Damarlı kesit:35mm ² /Tek Damarlı Kesit:16mm ²	9002660000	970,00 TL	1
KT 14	14 mm max. Çap/Örgü kesit:35mm ² /Çok Damarlı kesit:70mm ² /Tek Damarlı Kesit:16mm ²	1157820000	1.069,00 TL	1
KT 22	22 mm max. Çap/Örgü kesit:50mm ² /Çok Damarlı kesit:95mm ² /Tek Damarlı Kesit:25mm ²	1157830000	1.325,00 TL	1
KTF 36	35 mm max. Çap/Örgü kesit:300mm ² /Çok Damarlı kesit:300mm ²	9002190000	9.431,00 TL	1
KT 45 R	45 mm max. Çap/Örgü kesit:300mm ² /Çok Damarlı kesit:400mm ²	9202040000	7.860,00 TL	1
KT 55	55 mm max. Çap/Örgü kesit:500mm ² /Çok Damarlı kesit:500mm ²	9202060000	11.426,00 TL	1
KT 80	80 mm max. Çap/Örgü kesit:630mm ² /Çok Damarlı kesit:630mm ²	9202080000	21.568,00 TL	1
Üst Köprü, Kanal ve Ray Kesme				
WAW 1 NEUTRAL	WQV 2.5 ile WQV 35 arasındaki üst köprüleri kesmek için	9004500000	1.008,00 TL	1
WAW 2	Klemens Köprü Açma El Aleti	9004510000	998,00 TL	1
KT ZQV	Z serisi üst köprüleri kırma/kesme el aleti	9002170000	780,00 TL	1
VKSW	Kanal Kesme Makinası (125mm genişliğe kadar olan kablo kanalları için)	1137530000	20.000,00 TL	1
TSLD 5	Ray Kesme Makinası	9918700000	33.869,00 TL	1
Kablo Soyma				
STRIPAX	0,08...10mm ² arası kesit PVC kablolar için kesme ve soyma	9005000000	1.034,00 TL	1
ERME 10 ² SPX 4	Stripax için yedek bıçak	1119030000	315,70 TL	1
STRIPAX 16	6...16mm ² arası kesit PVC kablolar için	9005610000	2.622,00 TL	1
ERME 16 ² SPX 4	Stripax 16 için yedek bıçak	1119040000	629,00 TL	1
STRIPAX ULTIMATE	Halogen Free Kablolar İçin 0.25...6 mm ² arası kesitler için	1468880000	1.229,00 TL	1
STRIPAX ULTIMATE XL	Halogen Free Kablolar İçin 2.5...10 mm ² arası kesitler için	1512780000	1.481,00 TL	1
multi-stripax 6-16	6, 10, 16 mm ² kesite sahip sert ve yumuşak izolasyonlu kablolar için	9202210000	5.126,00 TL	1
AM 12	0.5...12.5mm çap aralığına sahip UTP ve STP data kabloları için	9030060000	560,00 TL	1
AM 16	6...17 mm çap aralığına sahip PVC kablolar için	9204190000	1.310,00 TL	1
AM 25	6...25mm çap aralığına sahip PVC kablolar için	9001540000	970,00 TL	1
AM 35	25...36mm çap aralığına sahip PVC kablolar için	9001080000	970,00 TL	1
IE-CST	2.5...8 mm çap aralığına sahip Coaxial ve Data kablolar için	9204350000	1.207,00 TL	1
CST	2.5...8 mm çap aralığına sahip Coaxial ve Data kablolar için	9030500000	878,00 TL	1
CST Cassette	CST İçin Bıçak Kaseti, Çeşitleri İçin Bilgi Alınız	9032xx0000	Sorunuz	Sorunuz
CST VARIO	2.5...8 mm çap aralığına sahip Coaxial ve Data kablolar için	9005700000	1.463,00 TL	1
IE-CST Weidmüller Ethernet kablosuna göre ayarlanmış bıçak kasetini içermektedir. CST ürünü herhangi bir bıçak kaseti içermemektedir.Ek olarak seçilip sipariş edilmelidir.				
Yüksük Sıkma				
STRIPAX PLUS 2.5	0,5...2.5mm ² kesit aralığına sahip PVC kablolar için Kesme,Soyma ve Sıkma	9020000000	3.462,00 TL	1
PZ 1.5	0.14...1.5mm ² kesit aralığında V tipi sıkma	9005990000	2.464,00 TL	1
PZ 10 HEX	0.14...10mm ² kesit aralığında tek yuvada hexagonal sıkma	1445070000	3.997,00 TL	1
PZ 10 SQR	0.14...10mm ² kesit aralığında tek yuvada kare sıkma	1445080000	3.284,00 TL	1
PZ 6/5	0.25...6mm ² kesit aralığında 5 farklı yuvada W tipi sıkma	9011460000	3.396,00 TL	1
PZ 6 Roto	0.14...6mm ² kesit aralığında tek yuvada V tipi sıkma-Dönebilir	9014350000	3.001,00 TL	1
PZ 6 ROTO L	0.14...6mm ² kesit aralığında tek yuvada V tipi sıkma-Dönebilir,Kitlenebilir çene	1444050000	3.001,00 TL	1
PZ 16	6...16mm ² kesit aralığında 3 farklı yuvada W tipi sıkma	9012600000	3.396,00 TL	1
PZ 50	25...50mm ² kesit aralığında 3 farklı yuvada W tipi sıkma	9006450000	5.226,00 TL	1
Faston Papuç Sıkma				
HTF 28	0.1...1mm ² kesit aralığında papuç bağlantı genişliği:2.8mm	9013090000	4.898,00 TL	1
HTF 48	0.5...2.5mm ² kesit aralığında papuç bağlantı genişliği:4.8mm	9013080000	4.898,00 TL	1
HTF 63	0.5...2.5mm ² kesit aralığında papuç bağlantı genişliği:6.3mm	9013400000	5.033,00 TL	1
CTF 63	0,5...6mm ² kesit aralığında papuç bağlantı genişliği:6.3mm	9202860000	7.754,00 TL	1



CTI 6 G



HTN 21



CTX CM 1.6/2.5



TT 864 RS



APG 80



IE-KO-HAT



SDIS 0.4X2.5X75

Tip	Açıklama	Sipariş No	Fiyat/Birim	Ambalaj
İzoleli Papuç Sıkma				
CTI 6 G	0,5...6 mm ² kesit aralığında Amerika standardına uygun paralel sıkma	9202850000	3.331,00 TL	1
CTI 6	0,5...6 mm ² kesit aralığında Avrupa standardına uygun çift sıkma	9006120000	3.331,00 TL	1
HTI 15	0,5...2,5 mm ² kesit aralığında Avrupa standardına uygun çift sıkma	9014400000	2.426,00 TL	1
İzolesiz Papuç Sıkma				
HTN 21	0,5...6 mm ² kesit aralığında (nokta baskı sıkma)	9014610000	3.331,00 TL	1
CTN 25 D4	10...25 mm ² kesit aralığında yuvarlak tip crimp kontak sıkma (nokta baskı sıkma)	9006220000	4.582,00 TL	1
CTN 25 D5	10...25 mm ² kesit aralığında yuvarlak tip crimp kontak sıkma (paralel hexagonal baskı sıkma)	9006230000	4.582,00 TL	1
Crimp Kontak Sıkma				
CTX CM 1.6/2.5	Crimp kontak sıkma el aleti / 0.14mm ² ... 4mm ²	9018490000	6.811,00 TL	1
CTX CM 3.6	4...10 mm ² kesit aralığında yuvarlak HD ve Concept M3 kontaklar için	9018480000	6.811,00 TL	1
CTIN CM 1.6/2.5	0.14...4 mm ² kesit aralığında yuvarlak HD,HE,HX ve M10,M5,M3 kontaklar için(Elektronk Kontrol)	9205430000	19.918,00 TL	1
CTIN CM 3.6	1,5...10 mm ² kesit aralığında yuvarlak HX ve M3 kontaklar için (Elektronk Kontrol)	9205440000	19.918,00 TL	1
HTX LWL	Fiber Optik Konnektör Sıkma	9011360000	4.090,00 TL	1
Data ve Tel. Konnektör Sıkma				
TT 864 RS	4,6 ve 8 pin sıkma	9008120000	4.844,00 TL	1
TT 1064 RS	4,6 ve 10 pin sıkma	9008190000	6.895,00 TL	1
SKP Papuç Sıkma - APG				
APG 80	6 - 300 mm ² Hidrolik Papuç Sıkma Aleti (Şarjlı Otomatik)	1502390000	55.000,00 TL	1
APG 55	6 - 240 mm ² Hidrolik Papuç Sıkma Aleti (Otomatik Şarjlı)	1501390000	39.574,00 TL	1
ES APG/HPG80 HEX 6	6 mm ² Çene - Bakır Papuçlar İçin	1502600000	1.903,00 TL	1
ES APG/HPG80 HEX 10	10 mm ² Çene - Bakır Papuçlar İçin	1502620000	1.903,00 TL	1
ES APG/HPG80 HEX 16	16 mm ² Çene - Bakır Papuçlar İçin	1502630000	1.903,00 TL	1
ES APG/HPG80 HEX 25	25 mm ² Çene - Bakır Papuçlar İçin	1502640000	1.903,00 TL	1
ES APG/HPG80 HEX 35	35 mm ² Çene - Bakır Papuçlar İçin	1502650000	1.903,00 TL	1
ES APG/HPG80 HEX 50	50 mm ² Çene - Bakır Papuçlar İçin	1502670000	1.903,00 TL	1
ES APG/HPG80 HEX 70	70 mm ² Çene - Bakır Papuçlar İçin	1502680000	1.903,00 TL	1
ES APG/HPG80 HEX 95	95 mm ² Çene - Bakır Papuçlar İçin	1502690000	1.903,00 TL	1
ES APG/HPG80 HEX 120	120 mm ² Çene - Bakır Papuçlar İçin	1502700000	1.903,00 TL	1
ES APG/HPG80 HEX 150	150 mm ² Çene - Bakır Papuçlar İçin	1502720000	1.903,00 TL	1
ES APG/HPG80 HEX 185	185 mm ² Çene - Bakır Papuçlar İçin	1502730000	1.903,00 TL	1
ES APG/HPG80 HEX 240	240 mm ² Çene - Bakır Papuçlar İçin	1502740000	1.903,00 TL	1
ES APG/HPG80 HEX 300	300 mm ² Çene - Bakır Papuçlar İçin	1502750000	2.112,00 TL	1
Kablo Bağı Sıkma				
KABELBINDERZANGE RT-1	2,5...4,8 mm genişliğinde ve max. 1,6 mm kalınlığında plastik kablo bağları için	1296000000	995,00 TL	1
WSM TOOL AUTOMATIK	4,6 mm genişliğinde çelik kablo bağları için	1774470000	1.782,00 TL	1
WSM TOOL MANUELL	4,6 mm genişliğinde çelik kablo bağları için	1774480000	8.915,00 TL	1
Hidrolik Punch				
IE-KO-HAT	Hidrolik Punch	1966810000	14.389,00 TL	1
Not:Metrik,PG,Ethernet,HDC,Kablo ve Vida Vb... Çene Aksesuarları için Lütfen Bilgi Alınız.				
Klemens Tornavidaları - İzoleli (VDE) (1000 Volt)				
SDIS 0.4X2.5X75	Düz-(Uç Kalınlık x Uç Uzunluk x Boy Uzunluk)	9008370000	185,05 TL	1
SDIS 0.5X3.0X100	Düz-(Uç Kalınlık x Uç Uzunluk x Boy Uzunluk)	9008380000	193,80 TL	1
SDIS 0.6X3.5X100	Düz-(Uç Kalınlık x Uç Uzunluk x Boy Uzunluk)	9008390000	237,35 TL	1
SDIS 0.8X4.0X100	Düz-(Uç Kalınlık x Uç Uzunluk x Boy Uzunluk)	9008400000	237,35 TL	1
SDIS 1.0X4.5X125	Düz-(Uç Kalınlık x Uç Uzunluk x Boy Uzunluk)	9008910000	246,00 TL	1
SDIS 1.0X5.5X125	Düz-(Uç Kalınlık x Uç Uzunluk x Boy Uzunluk)	9008410000	291,80 TL	1

Serinin devamı sayfa 60



SDIS SL 0.6X3.5X100



SDS 0.4X2.0X60



SD Set S2.5-5.5/PH1/2



SWIFTY SET



DMS 3 SET 1



SK WSD-S 1.5-10.0



CROSS-KEY MASTER



KBZ 160

Tip	Açıklama	Sipariş No	Fiyat/Birim	Ambalaj
SDIK PH1	Yıldız-Size 1- Boy uzunluk: 80mm	9008570000	246,00 TL	1
SDIK PH2	Yıldız-Size 2- Boy uzunluk: 100mm	9008580000	293,95 TL	1
SDI SL S3.5-6.5/PH1/2	İzoleli tornavida seti- 4 Düz/2 Yıldız(İnce Seri)	1274750000	1.163,00 TL	1
SDIS SL 0.6X3.5X100	Düz-(Uç Kalınlık x Uç Uzunluk x Boy Uzunluk)(İnce Seri)	1274660000	169,80 TL	1
SDIS SL 0.8X4.0X100	Düz-(Uç Kalınlık x Uç Uzunluk x Boy Uzunluk)(İnce Seri)	1274670000	200,35 TL	1
SDIS SL 1.0X5.5X125	Düz-(Uç Kalınlık x Uç Uzunluk x Boy Uzunluk)(İnce Seri)	1274680000	241,70 TL	1
SDIS SL 1.2X6.5X150	Düz-(Uç Kalınlık x Uç Uzunluk x Boy Uzunluk)(İnce Seri)	1274690000	315,70 TL	1
SDIK PH1 SL	Yıldız-Size 1- Boy uzunluk: 80mm(İnce Seri)	1274710000	224,20 TL	1
SDIK PH2 SL	Yıldız-Size 2- Boy uzunluk: 100mm(İnce Seri)	1274720000	302,65 TL	1
SDIK PZ1 SL	Yıldız-Size 1- Boy uzunluk: 80mm(İnce Seri)	1274730000	259,15 TL	1
SDIK PZ2 SL	Yıldız-Size 2- Boy uzunluk: 100mm(İnce Seri)	1274740000	359,30 TL	1
SDI SL S3.5-6.5/PZ1/2	Yıldız-Size 1-2- Boy uzunluk:80-100mm(İnce Seri)	1445930000	1.244,00 TL	1

Klemens Tornavidaları - İzolesiz (VDE)

SDS 0.4X2.0X60	Düz-(Uç Kalınlık x Uç Uzunluk x Boy Uzunluk)	9037160000	121,90 TL	1
SDS 0.4X2.5X75	Düz-(Uç Kalınlık x Uç Uzunluk x Boy Uzunluk)	9009030000	137,15 TL	1
SDS 0.5X3.0X80	Düz-(Uç Kalınlık x Uç Uzunluk x Boy Uzunluk)	9008320000	154,55 TL	1
SDS 0.6X3.5X100	Düz-(Uç Kalınlık x Uç Uzunluk x Boy Uzunluk)	9008330000	154,55 TL	1
SDS 0.6X3.5X200	Düz-(Uç Kalınlık x Uç Uzunluk x Boy Uzunluk)	9010110000	169,80 TL	1
SDS 0.8X4.0X100	Düz-(Uç Kalınlık x Uç Uzunluk x Boy Uzunluk)	9008340000	185,05 TL	1
SDS 0.8X4.5X125	Düz-(Uç Kalınlık x Uç Uzunluk x Boy Uzunluk)	9009020000	185,05 TL	1
SDS 1.0X5.5X150	Düz-(Uç Kalınlık x Uç Uzunluk x Boy Uzunluk)	9008350000	265,60 TL	1
SDS 1.2X6.5X150	Düz-(Uç Kalınlık x Uç Uzunluk x Boy Uzunluk)	9009010000	270,00 TL	1
SDK PH0	Yıldız-Size 0- Boy uzunluk: 60mm	9008470000	154,55 TL	1
SDK PH1	Yıldız-Size 1- Boy uzunluk: 80mm	9008480000	193,80 TL	1
SDK PH2	Yıldız-Size 2- Boy uzunluk: 100mm	9008490000	265,60 TL	1
SDK PH3	Yıldız-Size 3- Boy uzunluk: 150mm	9008500000	415,85 TL	1
SDK PZ1	Yıldız-Size 1- Boy uzunluk: 80mm (Pozidriv tip uç)	9008530000	202,50 TL	1
SDK PZ2	Yıldız-Size 2- Boy uzunluk: 100mm (Pozidriv tip uç)	9008540000	270,00 TL	1
SD Set S2.5-5.5/PH1/2	İzolesiz tornavida seti- 4 Düz/2 Yıldız	9009740000	1.154,00 TL	1
SD Set S2.0-5.5	İzolesiz tornavida seti- 6 Düz	9205560000	1.154,00 TL	1

Kablo Kesme Aparatı - Tornavida ve Kontrol Kalem

SWIFTY SET	SD 0,6x3,5x100 tornavida ve kesme aparatı	9006060000	472,50 TL	1
SWIFTY	Kesme aparatı(uç genişliği 3.5mm ye kadar tornavidalar ve tek damarlı max. 1,5mm ² kesit kablo için)	9006020000	315,70 TL	1
SP 303	Kontrol Kalem	9006890000	38,00 TL	1

Şarjlı Tornavida

DMS 3 SET 1	Komple Uçlar, Şarj Ünitesi Kutu İçinde	9007470000	6.190,00 TL	1
DMS 3 SET 2	Set 1+ Yedek Şarj Cihazı	9007480000	6.730,00 TL	1
Bit-Box WI DMS 3	Uç Seti	9024970000	472,50 TL	1

Allen Anahtar Setleri

SK WSD-S 1,5-10,0	Size AF 1.5-2.5-3.4-5-6-8-10	9008850000	614,00 TL	1
SKS 2,0-8,0	Size Allen 2-2.5-3-4-5-6-8	9008860000	407,15 TL	1
SKS 2,0-8,0 MR	Size Torx 2-2.5-3-4-5-6-8	9008870000	468,65 TL	1
TH-S 9-40	Size Torx 9-10-15-20-25-27-30-40	9008880000	525,00 TL	1

Pano Anahtar Setleri

CROSS-KEY MASTER	1X7 mm Düz/ PH 2 Yıldız/ 5,7,8 mm Kare/ 9 mm Üçgen/ 4 mm Allen	9918150000	324,40 TL	1
CROSS-KEY UNIVERSAL	1X7 mm Düz/ PH 2 Yıldız/ 5,7,8 mm Kare/ 9 mm Yuvarlak/ 4 mm Allen	9918130000	324,40 TL	1
CROSS-KEY UNIVERSAL S	1X7 mm Düz/ PH 2 Yıldız/ 5,8 mm Kare/ 9 mm Üçgen/ 4 mm Yuvarlak	9918140000	317,90 TL	1

Pense VDE İzoleli (1000 Volt)

KBZ 160	160 mm / 60 HRC	9046280000	459,35 TL	1
---------	-----------------	------------	-----------	---

Serinin devamı sayfa 61



KSE 160



FRZ SG 160



VT DIGI PRO



TEMPHASER



MG KIT CA 600



CRIMP-SET PZ 6 ROTO L

Tip	Açıklama	Sipariş No	Fiyat/Birim	Ambalaj
KBZ 180	180 mm / 60 HRC	9046290000	494,30 TL	1
KBZ 200	200 mm / 60 HRC	9046300000	533,00 TL	1
KBZI 200	200 mm / 60 HRC / Telefon Tesisatları İçin	9046430000	588,00 TL	1
Yan Keski VDE İzoleli (1000 Volt)				
KSE 160	160 mm	9046410000	588,00 TL	1
KSE 200	200 mm	9046420000	592,00 TL	1
SE TOP	160 mm	9046340000	720,00 TL	1
SE HD 140	140 mm	9046310000	459,35 TL	1
SE HD 160	160 mm	9046320000	494,30 TL	1
SE HD 180	180 mm	9046330000	557,00 TL	1
Kargaburun VDE İzoleli (1000 Volt)				
FRZ SG 160	160 mm / 45 / 60 HRC, 45 derece eğik uçlu	9046390000	527,00 TL	1
FRZ SG 200	200 mm / 45 / 60 HRC, 45 derece eğik uçlu	9046400000	533,00 TL	1
FRZ S 160	160 mm / 60 HRC	9046370000	463,75 TL	1
FRZ S 200	200 mm / 60 HRC	9046380000	472,50 TL	1
FZ 160	160 mm / Düz Uç	9046350000	426,70 TL	1
RZ 160	160 mm / Yuvarlak Uç	9046360000	426,70 TL	1
Test ve Ölçü Aletleri (Faz Kalemi Tipi)				
* VT DIGI PRO	1 - 1000 V AC/DC, LCD ekran, Faz Sırası Göstegesi, buton ile 30mA RCD tetikleme, tek kutup faz testi, ışıklı ölçme problemleri	9918870000	2.431,00 TL	1
* VT COMBI PRO	6 - 690 V AC/DC, LED skala, Faz Sırası Göstegesi, tek kutup faz testi, ışıklı ölçme problemleri	9918860000	1.059,00 TL	1
* VT MASTER	12 - 690 V AC/DC, LED skala(12, 24, 50, 120, 230, 400, 690 V)	9918880000	959,00 TL	1
* VT	12 - 690 V AC/DC, LED skala(12, 50, 120, 230, 400, 690 V)	9918950000	345,50 TL	1
Test ve Ölçü Aletleri				
TEMPHASER	0.2 - 600 VAC/DC, 2,000 MΩ kadar direnç, 20 µF - 20 mF arası kapasite, 10 Hz - 40 kHz arası frekans, diyot ve faz sırası testi	9427300000	1.829,00 TL	1
MULTIMETER 125S	0.32 - 600 VAC/DC, 30 MΩ kadar direnç, Diyot Testi	9425830000	1.363,00 TL	1
MG KIT CA 600	0.2 - 600 V AC/DC, 0 - 600 A AC/DC amp., 2,000 MΩ kadar direnç, 20 µF - 20 mF arası kapasite, 10 Hz - 40 kHz arası frekans, diyot ve faz sırası testi	9427460000	4.327,00 TL	1
MULTIMETER 1037	0.2 - 1,000 V DC, 0.2 - 750 V AC, 200A AC ye kadar pens amp. Adaptörü, 200kΩ a kadar direnç ve 20 µF a kadar kapasite ölçümü	9423580000	3.390,00 TL	1
MULTIMETER C 2606	0.2 - 1,000 V DC, 0.2 - 750 V AC, 1000 A AC/DC ye kadar amp., 40 MΩ kadar direnç, 4 nF - 40 µF kapasite, 0.1 - 400 kHz frekans, diyot testi	9427370000	4.159,00 TL	1
LAN USB TESTER	LAN ve USB bağlantıları için network kablo test aleti, LED skala/ RJ45, USB A, USB B bağlantı tipi/ max 1000 mt	9205400000	1.263,00 TL	1
THERMOMETER 610 LC	-20°C...260°C derece lazer sıcaklık ölçümü	9427520000	3.145,00 TL	1
El Aletleri Seti				
CRIMP-SET PZ 6 ROTO L	PZ 6 ROTO, STRIPAX ve 7 Bölme Yüksük	9028680000	4.193,00 TL	1
CRIMP-SET PZ 6/5	PZ 6/5, STRIPAX ve 7 Bölme Yüksük	9028740000	4.716,00 TL	1
CRIMP-SET PZ 16	PZ 16, STRIPAX 16 ve 6 Bölme Yüksük	9025850000	4.716,00 TL	1
Crimpset PZ / CTI	CTI 6, STRIPAX ve 19 Bölme Pabuç	9202610000	8.915,00 TL	1
Crimp-Set Kontakte	25 Bölmeli Yüksük ve Pabuç Kutusu (Yüksük, Pabuç dahil)	9202640000	3.145,00 TL	1
H-LEERBOX 5	5 Bölmeli, Yuvarlak Tip Boş Yüksük Kutusu	9025940000	156,80 TL	1
Tool Set Combi Check	KT 8, Stripax, PZ 6 Roto, Combi Check ve Screwdriverset	9201650000	4.837,00 TL	1
PROFI SET	KT 8, Stripax, Screwdriverset ve SK WSD-S	9918840000	2.578,00 TL	1



P BAG SET 1



P BAG XL SET 10



Pro Case Insta

Tip	Açıklama	Sipariş No	Fiyat/Birim	Ambalaj
Takım Çantaları				
P BAG SET 1				
* P BAG SET 1	6 Parça El Tipi Takım Çantası	2561430000	5.200,00 TL	1
STRIPAX Ultimate	Halogen Free Kablolar için 0,25...6 mm ² kesitler için	-	-	1
PZ 10 HEX	0,14...10 mm ² kesit aralığında tek yuvada hexagonal sıkma	-	-	1
SDIS 0,6X3,5X100	Düz (Uç kalınlık x Uç Uzunluk x Boy Uzunluk)	-	-	1
SKS 2,0-8,0	Size Allen 2-2.5-3-4-5-6-8	-	-	1
KBZ 160	160 mm / 60 HRC	-	-	1
P BAG	Boş küçük tip el çantası	-	-	1
P BAG XL SET 10				
* P BAG XL SET 10	10 Parça El Tipi Takım Çantası	2602200000	6.800,00 TL	1
P BAG BIG	Boş Büyük Tip El Çantası	-	-	1
KT 8	8 mm max. Çap/Örgü kesit:16mm ² /Çok Damarlı kesit:16mm ² /Tek Damarlı Kesit:16mm ²	-	-	1
STRIPAX 16	6...16mm ² arası kesit PVC kablolar için	-	-	1
VT COMBI PRO	6 - 690 V AC/DC, LED skala, Faz Sırası Göstegesı, tek kutup faz testi, ışıklı ölçme problemleri	-	-	1
AM 25	6...25mm çap aralığına sahip PVC kablolar için	-	-	1
PZ 16	6...16mm ² kesit aralığında 3 farklı yuvada W tipi sıkma	-	-	1
SDIK PH1 SL	Yıldız-Size 1- Boy uzunluk: 80mm(İnce Seri)	-	-	1
SDIK PH2 SL	Yıldız-Size 2- Boy uzunluk: 100mm(İnce Seri)	-	-	1
SDIS SL 0.6X3.5X100	Düz-(Uç Kalınlık x Uç Uzunluk x Boy Uzunluk)(İnce Seri)	-	-	1
SDIS SL 0.8X4.0X100	Düz-(Uç Kalınlık x Uç Uzunluk x Boy Uzunluk)(İnce Seri)	-	-	1
Pro Case Insta				
Pro Case Insta	18 Parça Takım Çantası	9203160000	14.413,00 TL	1
AM 25	6...25 mm çap aralığına sahip kabloları soyma	-	-	1
KT 8	16mm ² kesite kadar olan kabloları kesme	-	-	1
STRIPAX	0.08...10mm ² kesit aralığına sahip kablo soyma ve kesme	-	-	1
PZ 6 Roto	0,14...6mm ² kesit aralığında olan kablolar için yüksek sıkma(tek çene)	-	-	1
H-BOX 0,5-2,5QMM DIN	0.5...2.5 mm ² kesit aralığında yükseklerinde içinde bulunduğu yüksek kutusu	-	-	1
AM 12	0.5...12.5mm çap aralığına sahip kabloları soyma	-	-	1
COMBI CHECK	6-690 V AC/DC,LED skala,Faz Sırası Göstegesı, tek kutup faz testi,ışıklı ölçme problemleri	-	-	1
FLEXIMET 5 M	Weidmüller çelik metre	-	-	1
Pro Case leer	BEZ ÇANTA	-	-	1
STRIPPER ROUND TOP	8...13mm çap aralığında çok damarlı kabloları çift kademeli soyma	-	-	1
FRZ S 160	160 mm / 60 HRC Kargaburun	-	-	1
SE HD 180	Sert kablolar için diogonal kesme pensesi	-	-	1
KBZ 180	180 mm / 60 HRC pense	-	-	1
CROSS-KEY UNIVERSAL	pano anahtarı	-	-	1
SK WSD-S 1,5-10,0	9 parçadan oluşan alyan anahtarı seti	-	-	1
SDI Set S2.5-5.5/PH1/2	6 parçadan oluşan izoleli tornavida seti	-	-	1
SKS 2,0-8,0 MR	7 parçadan oluşan alyan anahtarı	-	-	1
PACK HEXA 8-13	lokma anahtar takımı	-	-	1



Pro Case Premium

Tip	Açıklama	Sipariş No	Fiyat/Birim	Ambalaj
Pro Case Premium				
Pro Case Premium	25 Parça Takım Çantası	9202460000	24.112,00 TL	1
AM 25	6...25 mm çap aralığına sahip kabloları soyma	-	-	1
KT 8	16mm ² kesite kadar olan kabloları kesme	-	-	1
STRIPAX	0.08...10mm ² kesit aralığına sahip kablo soyma ve kesme	-	-	1
PZ 6 Roto	0,14...6mm ² kesit aralığında olan kablolar için yüksek sıkma (tek çene)	-	-	1
H-BOX 0,5-2,5QMM DIN	0.5...2.5 mm ² kesit aralığında yüksüklerinde içinde bulunduğu yüksük kutusu	-	-	1
AM 12	0.5...12.5mm çap aralığına sahip kabloları soyma	-	-	1
DIGI CHECK	0,3 - 690 V AC/DC, LCD ekran, tek kutup faz testi, ışıklı ölçme problemleri	-	-	1
COMBI CHECK	6-690 V AC/DC, LED skala, Faz Sırası Göstegesi, tek kutup faz testi, ışıklı ölçme problemleri	-	-	1
Pro Case leer	BEZ ÇANTA	-	-	1
STRIPPER ROUND TOP	8...13mm çap aralığında çok damarlı kabloları çift kademeli soyma	-	-	1
FRZ S 160	160 mm / 60 HRC Kargaburun	-	-	1
SE HD 180	Sert kablolar için diogonal kesme pensesi	-	-	1
KBZ 180	180 mm / 60 HRC pense	-	-	1
RZ 160	160 mm / Yuvarlak Uç	-	-	1
AIZ 160	5mm çapa kadar yan keski	-	-	1
CROSS-KEY UNIVERSAL	pano anahtarı	-	-	1
SWIFTY SET	SD 0,6x3,5x100 tornavida ve kesme aparatı	-	-	1
SK WSD-S 1,5-10,0	9 parçadan oluşan alyan anahtarı seti	-	-	1
SD Set S2.5-5.5/PH1/2	6 parçadan oluşan izolesiz tornavida seti	-	-	1
SDI Set S2.5-5.5/PH1/2	6 parçadan oluşan izoleli tornavida seti	-	-	1
Bit-Box WI DMS 3	9 parça tornavida uç seti	-	-	1
SKS 2,0-8,0 MR	7 parçadan oluşan alyan anahtarı	-	-	1
TESTBOY 20	Işıklı kontrol test kalem	-	-	1
WK S 0,5x3,0	0.5 x 3 boyutunda değiştirilebilir	-	-	1
DMS MANUELL 0,5-1,7	0.5-1.7 Nm Tork ayarlı Tornavida	-	-	1

Tip	Açıklama	Sipariş No	Fiyat/Birim	Ambalaj
Top Case Insta				
TOP CASE INSTA	18 Parça Takım Çantası	1345310000	19.500,00 TL	1
AM 25	6...25 mm çap aralığına sahip kabloları soyma	-	-	1
KT 8	16mm ² kesite kadar olan kabloları kesme	-	-	1
STRIPAX	0.08...10mm ² kesit aralığına sahip kablo soyma ve kesme	-	-	1
PZ 6 Roto	0,14...6mm ² kesit aralığında olan kablolar için yüksek sıkma (tek çene)	-	-	1
H-BOX 0,5-2,5QMM DIN	0.5...2.5 mm ² kesit aralığında yüksüklerinde içinde bulunduğu yüksük kutusu	-	-	1
AM 12	0.5...12.5mm çap aralığına sahip kabloları soyma	-	-	1
COMBI CHECK	6-690 V AC/DC, LED skala, Faz Sırası Göstegesi, tek kutup faz testi, ışıklı ölçme problemleri	-	-	1
PLASTIC CASE	PLASTİK SERT KAPAK ÇANTA	-	-	1
STRIPPER ROUND TOP	8...13mm çap aralığında çok damarlı kabloları çift kademeli soyma	-	-	1
FRZ S 160	160 mm / 60 HRC Kargaburun	-	-	1
SE HD 180	Sert kablolar için diogonal kesme pensesi	-	-	1
KBZ 180	180 mm / 60 HRC pense	-	-	1
CROSS-KEY UNIVERSAL	pano anahtarı	-	-	1
SK WSD-S 1,5-10,0	9 parçadan oluşan alyan anahtarı seti	-	-	1
SDI Set S2.5-5.5/PH1/2	6 parçadan oluşan izoleli tornavida seti	-	-	1
SKS 2,0-8,0 MR	7 parçadan oluşan alyan anahtarı	-	-	1
Pack HEXA P-13	lokma anahtar takımı	-	-	1
Fleximet M5	Weidmüller çelik metre	-	-	1



TOP CASE INSTA

El Aletleri



TOP CASE PREMIUM



P BAG BIG



Pro Case leer



CUTFIX 8



CRIMPFIX L



CRIMPFIX R VARIO



Tool Chest Empty



TC INL BIG 1

Tip	Açıklama	Sipariş No	Fiyat/Birim	Ambalaj
Top Case Premium				
TOP CASE PREMIUM	24 Parça Takım Çantası	1345320000	24.500,00 TL	1
AM 25	6...25 mm çap aralığına sahip kabloları soyma	-	-	1
KT 8	16mm ² kesite kadar olan kabloları kesme	-	-	1
STRIPAX	0.08...10mm ² kesit aralığına sahip kablo soyma ve kesme	-	-	1
PZ 6 Roto	0,14...6mm ² kesit aralığında olan kablolar için yüksek sıkma (tek çene)	-	-	1
H-BOX 0,5-2,5QMM DIN	0.5...2.5 mm ² kesit aralığında yüksüklerinde içinde bulunduğu yüksük kutusu	-	-	1
AM 12	0.5...12.5mm çap aralığına sahip kabloları soyma	-	-	1
DIGI CHECK	0,3-690 V AC/DC, LCD ekran, tek kutup faz testi, ışıklı ölçme problemleri	-	-	1
COMBI CHECK	6-690 V AC/DC, LED skala, Faz Sırası Göstergesi, tek kutup faz testi, ışıklı ölçme problemleri	-	-	1
PLASTIC CASE	PLASTİK SERT KAPAK ÇANTA	-	-	1
STRIPPER ROUND TOP	8...13mm çap aralığında çok damarlı kabloları çift kademeli soyma	-	-	1
FRZ S 160	160 mm / 60 HRC Kargaburun	-	-	1
SE HD 180	Sert kablolar için diogonal kesme pensesi	-	-	1
KBZ 180	180 mm / 60 HRC pense	-	-	1
RZ 160	160 mm / Yuvarlak Uç	-	-	1
CROSS-KEY UNIVERSAL	pano anahtarı	-	-	1
SWIFTY SET	SD 0,6x3,5x100 tornavida ve kesme aparatı	-	-	1
SK WSD-S 1,5-10,0	9 parçadan oluşan alyan anahtarı seti	-	-	1
SD Set S2.5-5.5/PH1/2	6 parçadan oluşan izolesiz tornavida seti	-	-	1
SDI Set S2.5-5.5/PH1/2	6 parçadan oluşan izoleli tornavida seti	-	-	1
Bit-Box WI DMS 3	9 parça tornavida uç seti	-	-	1
SKS 2,0-8,0 MR	7 parçadan oluşan alyan anahtarı	-	-	1
WK S 0,5x3,0	0.5 x 3 boyutunda değiştirilebilir	-	-	1
DMS MANUELL 0,5-1,7	0.5-1.7 Nm Tork ayarlı Tornavida	-	-	1
AM 16	6...17 mm çap aralığına sahip PVC kablolar için	-	-	1

Tip	Açıklama	Sipariş No	Fiyat/Birim	Ambalaj
Boş Takım Çantaları				
* P BAG	Boş Küçük Tip El Çantası	2548180000	380,00 TL	1
* P BAG BIG	Boş Büyük Tip El Çantası	2576620000	480,00 TL	1
Pro Case leer	Boş Takım Çantası Bez	9202470000	1.850,00 TL	1
TOP CASE	Boş Takım Çantası Metal Çerçeve	1345330000	4.800,00 TL	1

Tip	Açıklama	Sipariş No	Fiyat/Birim	Ambalaj
Otomatik Makinalar				
CUTFIX 8	0,14...10mm ² flexible kablo kesme	9023100000	6.967,00 €	1
POWERSTRIPPER 6,0	0,14-6mm ² güçlü soyma	9028510000	3.795,00 €	1
POWERSTRIPPER 16,0	2,5-16mm ² güçlü soyma	9028480000	5.417,00 €	1
POWERSTRIPPER ao 2,5-20	0,5-2,5mm ² otomatik soyma	9027270000	7.038,00 €	1
POWERSTRIPPER ao 16-20	4-16mm ² otomatik soyma	9027290000	7.521,00 €	1
CRIMPFIX R	Pnömatik soyma ve şerit yüksük sıkma	9028500000	19.680,00 €	1
CRIMPFIX L	0,5-2,5mm ² kablo soyma ve dökme yüksük sıkma, Pinomatik, 8 mm yüksük uç uzunluğu, 14mm yüksük uzunluğu için	9028530000	24.000,00 €	1
CRIMPFIX LS	0,5-2,5mm ² kablo soyma ve dökme yüksük sıkma, Pinomatik, 6/8/10 mm yüksük uç uzunluğu, 12/14/16 mm yüksük uzunluğu için	9028540000	28.000,00 €	1
CRIMPFIX LZ	Çift girişli dökme yüksük sıkma	9027310000	28.360,00 €	1
* CRIMPFIX R VARIO	Kablo soyma ve çoklu şerit yüksük sıkma	2580000000	29.167,00 €	1

Not: Otomatik Kesme, Soyma ve Yüksük Sıkma Makinaları Hakkında Teknik ve Fiyat Bilgisi için Bölge Satış Temsilcimizle iletişime geçiniz.

Tip	Açıklama	Genişlik/Derinlik Yükseklik (mm)	Sipariş No	Fiyat/Birim	Ambalaj
Takım Çantaları					
Çekmeceli Takım Dolapları					
* Tool Chest Empty	Boş dolap	894 / 525 / 928	2683640000	24.407,00 TL	1
* TC INL BIG 1	Dolu çekmece içi		2683720000	20.136,00 TL	1

Not: Daha fazlası için QR kodu okutabilirsiniz.

Kutular

Weidmüller'in çok geniş bir ürün yelpazesini oluşturan kutular, elektrik bağlantılarını ve komponentlerini çok çeşitli şartlar ve zorlu çevre koşullarından korumak için tasarlandı ve bu şartlarda test edilerek kullanıma sunuldu.

Klippon K Alüminyum Kutular

K serisi alüminyum kutuların birçok uygulama sahası vardır. K serisi kutuların içlerine klemensler, şalterler, butonlar, göstergeler ve elektronik komponentler montaj edilebilir.

Özellikleri:

- 2 tip olarak 19 ayrı ölçü
- Paslanmaz çelik kapak vidaları
- Montaj delikleri kutu içinden izoleli
- Raylar ve diğer montaj plakaları için açılmış vida dişleri
- IP 66, IP 67 ve IP 68 koruma sınıfı
- Yağmur, erimiş kar ve çığ gibi koşullarda kullanılabilir.

Endüstri ve ulaşımda kullanılabilir. Ayrıca ATEX standartlarına uygun olduğundan patlama tehlikesi olan ortamlarda kullanılabilir.

Klippon POK Polyester Kutular

Cam elyafları içeren kuvvetlendirilmiş POK serisi polyester kutular hem iç ortamlarda hem de dış ortamlarda kullanılmaya uygundur.

Özellikleri:

- 2 tip olarak 17 ölçü
- Paslanmaz çelik kapak vidaları
- Montaj delikleri kutu içinden izole
- Raylar ve diğer montaj plakaları için açılmış vida delikleri
- IP 66 Koruma sınıfı

Bu kutular özellikle paslanma ve darbeye karşı, yüksek koruma sınıfı gerektiren uygulamalarda tercih edilirler.





KLIPPON K02



KLIPPON POK 081606



KLIPPON POK 080806



MPC 12/12/07 7035



MPC 07/12/07 7035



FPC 20/20/13 7035

Tip	Boy x En x Derinlik (mm)	Ağırlık	Sipariş No	Fiyat/Birim	Ambalaj
Alüminyum Döküm Gövde- Klippon® K					
KLIPPON K0	45 x 50 x 30	65 g	0573200000	8,70 €	10
KLIPPON K01	64 x 58 x 34	120 g	1565240000	17,40 €	10
KLIPPON K02	64 x 98 x 34	200 g	1565250000	20,10 €	6
KLIPPON K1	70 x 70 x 45	220 g	0342000000	16,06 €	10
KLIPPON K11	80 x 75 x 57	280 g	0573300000	21,43 €	10
KLIPPON K2	70 x 100 x 45	280 g	0342100000	25,42 €	10
KLIPPON K21	80 x 125 x 57	400 g	0573400000	20,00 €	5
KLIPPON K3	70 x 165 x 45	400 g	0342200000	21,43 €	5
KLIPPON K31	80 x 175 x 57	520 g	0573500000	25,42 €	5
KLIPPON K32	80 x 250 x 55	710 g	1565260000	40,15 €	1
KLIPPON K4	82 x 130 x 72	620 g	0342300000	28,13 €	1
KLIPPON K41	120 x 122 x 81	840 g	1565270000	45,00 €	1
KLIPPON K5	130 x 170 x 90	1540 g	0342400000	56,21 €	1
KLIPPON K51	120 x 220 x 81	1280 g	1565280000	56,00 €	1
KLIPPON K52	160 x 160 x 91	1480 g	1565290000	61,60 €	1
KLIPPON K6	160 x 200 x 100	2000 g	0342500000	62,91 €	1
KLIPPON K61	160 x 260 x 91	2060 g	0573600000	77,65 €	1
KLIPPON K7	160 x 350 x 100	2870 g	0342600000	93,71 €	1
KLIPPON K71	230 x 280 x 111	2925 g	0573700000	109,77 €	1
Polyester - Klippon® POK					
KLIPPON POK 080806	75 x 80 x 55	230 g	1305810000	27,50 €	1
KLIPPON POK 081106	75 x 110 x 55	295 g	1305820000	32,00 €	1
KLIPPON POK 081606	75 x 160 x 55	405 g	1305830000	32,70 €	1
KLIPPON POK 081906	75 x 190 x 55	450 g	1305840000	37,95 €	1
KLIPPON POK 082306	75 x 230 x 55	575 g	1305850000	40,60 €	1
KLIPPON POK 121209	120 x 122 x 90	750 g	1305870000	48,00 €	1
KLIPPON POK 122209	120 x 220 x 90	1060 g	1305880000	49,70 €	1
KLIPPON POK 161609	160 x 160 x 90	1290 g	1305890000	58,00 €	1
KLIPPON POK 162609	160 x 260 x 90	1710 g	1305900000	88,00 €	1
KLIPPON POK 163609	160 x 360 x 90	2150 g	1305910000	90,30 €	1
KLIPPON POK 165609	160 x 560 x 90	3185 g	1305920000	149,00 €	1
KLIPPON POK 252512	250 x 255 x 120	2650 g	1305930000	117,00 €	1
KLIPPON POK 254012	250 x 400 x 120	3650 g	1305940000	143,00 €	1
KLIPPON POK 256012	250 x 600 x 120	5235 g	1305950000	204,00 €	1
KLIPPON POK 404012	405 x 400 x 120	5580 g	1305970000	173,00 €	1
KLIPPON POK 252516	250 x 255 x 160	3275 g	1305980000	149,00 €	1
KLIPPON POK 254016	250 x 400 x 160	4800 g	1305990000	196,00 €	1
Polikarbonat - Klippon® MPC					
MPC 07/12/07 7035	125 x 75 x 75	209 g	9535170000	17,50 €	1
MPC 07/12/12 7035	125 x 75 x 125	300 g	9535210000	20,00 €	1
MPC 12/12/07 7035	125 x 125 x 75	283 g	9535230000	19,00 €	1
MPC 12/17/07 7035	175 x 125 x 75	381 g	9535290000	23,80 €	1
MPC 12/17/10 7035	175 x 125 x 100	465 g	9535310000	24,85 €	1
MPC 12/17/12 7035	175 x 125 x 125	530 g	9535330000	25,95 €	1
MPC 17/17/07 7035	175 x 175 x 75	461 g	9535370000	30,05 €	1
MPC 17/17/15 7035	175 x 175 x 150	717 g	9535430000	41,10 €	1
MPC 17/25/10 7035	250 x 175 x 100	743 g	9535470000	48,65 €	1
Polikarbonat - Klippon® FPC					
FPC 20/20/13 7035	200 x 200 x 130	1039 g	9535690000	53,55 €	1
FPC 20/30/13 7035	200 x 300 x 130	1349 g	9535710000	69,00 €	1

Serinin devamı sayfa 67



FPC 20/40/13 7035



KTB QL 303020 SE4



KTB MH 221513 S4E1



KTB MH 262620 S4E1

Tip	Boy x En x Derinlik (mm)	Ağırlık	Sipariş No	Fiyat/Birim	Ambalaj
FPC 20/40/13 7035	200 x 400 x 130	1674 g	9535730000	93,00 €	1
FPC 30/30/13 7035	300 x 300 x 130	1738 g	9535750000	95,15 €	1
FPC 30/40/13 7035	300 x 400 x 130	2199 g	9535770000	113,00 €	1
FPC 40/60/13 7035	400 x 600 x 130	3964 g	9535810000	215,00 €	1

	Klippon TB MH	Klippon TB QL	Klippon STB
--	---------------	---------------	-------------

Paslanmaz Çelik - Yeni Seri

Malzeme	Paslanmaz Çelik	Paslanmaz Çelik	Paslanmaz Çelik
Malzeme Özellikleri	"Paslanmaz Çelik 1.4404 (316L) 1.5 mm"	"Paslanmaz Çelik 1.4404 (316L) 1.5 mm"	"Paslanmaz Çelik 1.4404 (316L) 1.6 mm"
Su Dayanımı	çok iyi	çok iyi	çok iyi
UV Dayanımı	çok iyi	çok iyi	çok iyi
Halojen Free	x	x	x

			"Elektroliz yolu ile parlatılmış Ayna parlaklığı"
Yüzey	Elektroliz yolu ile parlatılmış	Elektroliz yolu ile parlatılmış	toz boya kaplı

Kullanım Amacı	Patlayıcı ortamlar, off-shore, yağ ve gaz endüstrisi, kimya endüstrisi, proses endüstrisi	Patlayıcı ortamlar, off-shore, yağ ve gaz endüstrisi, kimya endüstrisi, proses endüstrisi
----------------	---	---

Boyutlar			
LXWXH (min) mm	229x152x133	229x152x133	120x120x80
LXWXH (max) mm	987x740x200	987x740x200	250x400x130
Geometri	3 adet standart derinlik	3 adet standart derinlik	5 adet standart derinlik

Özel Karakteristikler			EX Tipi	Endüstriyel Tipi
Sıcaklık Aralığı	-60 °C...+135 °C	-60 °C...135 °C	-60 °C...100 °C	-60 °C...120 °C
Darbe Dayanımı	"10 Jendüstri Uygulamaları 7 J ATEX Uygulamalar"	"10 Jendüstri Uygulamaları 7 J ATEX Uygulamalar"	7J	10J
IP Koruma Sınıfı				

Uygunluk			
ATEX	x	x	x
- EN60079-7 Increased safety	x	x	x
- EN60079-11 Intrinsic safety	x	x	x
IECEX	x	x	
- IEC60079-7 Increased safety	x	x	
- IEC60079-11 Intrinsic safety	x	x	
GOST Ex	x	x	
GOST	*	*	
cULus	x	x	x
UL			
German Lloyd	x	x	x
Lloyds Register			x
Russian Maritime Register	x	x	
CCOE	*		

Tip	Boy x En x Derinlik (mm)	Koruma Sınıfı	Sipariş No	Fiyat/Birim	Ambalaj
Paslanmaz Çelik - Yeni Seri					
Paslanmaz Çelik - Klippon® TB MH - Multi Hinge					
KTB MH 221513 S4E1	229 x 152 x 133	IP66, IP67	1194560000	484,00 €	1
KTB MH 262615 S4E1	260 x 260 x 150	IP66, IP67	1194610000	571,00 €	1
KTB MH 262620 S4E1	260 x 260 x 200	IP66, IP67	1194660000	633,00 €	1
KTB MH 303015 S4E1	306 x 306 x 150	IP66, IP67	1194710000	610,00 €	1
KTB MH 303020 S4E1	306 x 306 x 200	IP66, IP67	1194760000	850,00 €	1
KTB MH 352615 S4E1	350 x 260 x 150	IP66, IP67	1194810000	618,00 €	1

Serinin devamı sayfa 68



KTB QL 262620 S4E1



KTB QL 221513 S4E1



KLIPPON STB 1 SS

Tip	Boy x En x Derinlik (mm)	Koruma Sınıfı	Sipariş No	Fiyat/Birim	Ambalaj
KTB MH 352620 S4E1	350 x 260 x 200	IP66, IP67	1194860000	850,00 €	1
KTB MH 403015 S4E1	400 x 300 x 150	IP66, IP67	1194910000	674,00 €	1
KTB MH 403020 S4E1	400 x 300 x 200	IP66, IP67	1194960000	764,00 €	1
KTB MH 453815 S4E1	458 x 382 x 150	IP66, IP67	1195010000	793,00 €	1
KTB MH 453820 S4E1	458 x 382 x 200	IP66, IP67	1195060000	1.000,00 €	1
KTB MH 484815 S4E1	480 x 480 x 150	IP66, IP67	1195110000	916,00 €	1
KTB MH 484820 S4E1	480 x 480 x 200	IP66, IP67	1195160000	1.220,00 €	1
KTB MH 553515 S4E1	550 x 350 x 150	IP66, IP67	1195210000	982,00 €	1
KTB MH 553520 S4E1	550 x 350 x 200	IP66, IP67	1195260000	982,00 €	1
KTB MH 624515 S4E1	620 x 450 x 150	IP66, IP67	1195310000	1.204,00 €	1
KTB MH 624520 S4E1	620 x 450 x 200	IP66, IP67	1195360000	1.282,00 €	1
KTB MH 765015 S4E1	762 x 568 x 150	IP66, IP67	1195410000	1.380,00 €	1
KTB MH 765020 S4E1	762 x 568 x 200	IP66, IP67	1195460000	1.619,00 €	1
KTB MH 916115 S4E1	914 x 610 x 150	IP66, IP67	1195510000	1.877,00 €	1
KTB MH 916120 S4E1	914 x 610 x 200	IP66, IP67	1195560000	1.914,00 €	1
KTB MH 987420 S4E1	980 x 740 x 200	IP66, IP67	1195610000	2.108,00 €	1

Paslanmaz Çelik - Klippon® TB QL - Quarter Lock

KTB QL 221513 S4E1	229 x 152 x 133	IP66	1199860000	542,00 €	1
KTB QL 262615 S4E1	260 x 260 x 150	IP66	1199910000	617,00 €	1
KTB QL 262620 S4E1	260 x 260 x 200	IP66	1199960000	657,00 €	1
KTB QL 303015 S4E1	306 x 306 x 150	IP66	1200020000	640,00 €	1
KTB QL 303020 S4E1	306 x 306 x 200	IP66	1200070000	684,00 €	1
KTB QL 352615 S4E1	350 x 260 x 150	IP66	1200120000	715,00 €	1
KTB QL 352620 S4E1	350 x 260 x 200	IP66	1200170000	755,00 €	1
KTB QL 403015 S4E1	400 x 300 x 150	IP66	1200230000	804,00 €	1
KTB QL 403020 S4E1	400 x 300 x 200	IP66	1200280000	846,00 €	1
KTB QL 453815 S4E1	458 x 382 x 150	IP66	1200340000	813,00 €	1
KTB QL 453820 S4E1	458 x 382 x 200	IP66	1200390000	850,00 €	1
KTB QL 484815 S4E1	480 x 480 x 150	IP66	1200450000	930,00 €	1
KTB QL 484820 S4E1	480 x 480 x 200	IP66	1200510000	1.064,00 €	1
KTB QL 553515 S4E1	550 x 350 x 150	IP66	1200560000	1.076,00 €	1
KTB QL 553520 S4E1	550 x 350 x 200	IP66	1200620000	1.076,00 €	1
KTB QL 624515 S4E1	620 x 450 x 150	IP66	1200670000	1.225,00 €	1
KTB QL 624520 S4E1	620 x 450 x 200	IP66	1200730000	1.281,00 €	1
KTB QL 765015 S4E1	762 x 568 x 150	IP66	1200780000	1.380,00 €	1
KTB QL 765020 S4E1	762 x 568 x 200	IP66	1200840000	1.619,00 €	1
KTB QL 916115 S4E1	914 x 610 x 150	IP66	1200890000	1.878,00 €	1
KTB QL 916120 S4E1	914 x 610 x 200	IP66	1200950000	1.915,00 €	1
KTB QL 987420 S4E1	980 x 740 x 200	IP66	1201010000	2.108,00 €	1

Paslanmaz Çelik - Klippon® STB

KLIPPON STB 1 SS	120 x 120 x 80	IP66	1002690000	180,00 €	1
KLIPPON STB 1.1 SS	150 x 120 x 80	IP66	1002750000	189,00 €	1
KLIPPON STB 2 SS	150 x 150 x 90	IP66	1002740000	197,00 €	1
KLIPPON STB 2.1 SS	190 x 150 x 90	IP66	1002730000	247,00 €	1
KLIPPON STB 3 SS	190 x 190 x 100	IP66	1002720000	259,00 €	1
KLIPPON STB 4 SS	250 x 250 x 120	IP66	1002710000	326,00 €	1
KLIPPON STB 5 SS	160 x 380 x 120	IP66	1002700000	405,00 €	1
KLIPPON STB 6 SS	250 x 400 x 130	IP66	1002760000	479,00 €	1

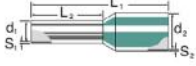

H1,0/14 GE



H0,5/6



H0,5/14 ZH OR

Tip	Renk	Sipariş No	Fiyat/Birim	Ambalaj
Kablo Bağlantı Yüksükleri				
İzoleli İletken Yüksükleri				
H0,5/14 OR	Turuncu	0690700000	0,131 TL	500
H0,75/14 W	Beyaz	0462900000	0,131 TL	500
H1,0/14 GE	Sarı	0463000000	0,131 TL	500
H1,5/14 R	Kırmızı	0463100000	0,131 TL	500
H1,5/16 R	Kırmızı	0635100000	0,240 TL	500
H1,5/24 R	Kırmızı	0565600000	0,317 TL	500
H2,5/14S BL	Mavi	1333100000	0,186 TL	500
H2,5/19D BL	Mavi	9019170000	0,300 TL	500
H2,5/25D BL	Mavi	9019180000	0,470 TL	500
H4,0/18D GR	Gri	9019190000	0,301 TL	500
H4,0/20D GR	Gri	9019200000	0,410 TL	500
H4,0/26D GR	Gri	9019210000	0,502 TL	100
H6,0/20 SW	Siyah	0533500000	0,414 TL	100
H6,0/26 SW	Siyah	0565700000	0,575 TL	100
H10,0/22 EB	Fildişi	0534200000	0,550 TL	100
H10,0/28 EB	Fildişi	0565800000	0,751 TL	100
H16,0/22 GN	Yeşil	0565900000	0,701 TL	100
H16,0/28 GN	Yeşil	0566000000	0,964 TL	100
H25,0/30 BR	Kahverengi	0317000000	1,60 TL	50
H25,0/36 BR	Kahverengi	0317100000	1,90 TL	50
H35,0/30 BE	Bej	0317200000	2,00 TL	50
H35,0/39 BE	Bej	0317300000	2,70 TL	50
H50/36 OLIV	Zeytin Yeşil	0444200000	3,50 TL	50
Tip	Ölçü	Sipariş No	Fiyat/Birim	Ambalaj
Kablo Bağlantı Yüksükleri				
İzolesiz İletken Yüksükleri				
H0,5/6	0.5 mm ² / 6 mm	0282600000	0,097 TL	1000
H0,75/10	0.75 mm ² / 10mm	0542500000	0,125 TL	1000
H1,0/10	1 mm ² / 10mm	0282800000	0,161 TL	1000
H1,5/10	1.5 mm ² / 10	0186500000	0,175 TL	1000
H2,5/12	2.5 mm ² / 12mm	0186100000	0,188 TL	1000
H4,0/12	4 mm ² / 12mm	0244100000	0,250 TL	1000
H6,0/12	6 mm ² / 12mm	0191900000	0,300 TL	500
H10,0/12	10 mm ² / 12mm	0282900000	0,350 TL	500
H16,0/12	16mm ² / 12mm	0492500000	0,500 TL	500
Tip	Renk	Sipariş No	Fiyat/Birim	Ambalaj
Kablo Bağlantı Yüksükleri				
Çift Girişli İzoleli İletken Yüksükleri				
H0,5/14 ZH OR	Turuncu	9037200000	0,362 TL	500
H0,75/14 ZH W	Beyaz	9037230000	0,382 TL	500
H1,0/15 ZH GE	Sarı	9037260000	0,382 TL	500
H1,5/16 ZH R	Kırmızı	9037290000	0,382 TL	500
H2,5/19D ZH BL	Mavi	9037500000	0,450 TL	500
H4,0/22D ZH GR	Gri	9037530000	1,13 TL	100
H6,0/23 ZH SW	Siyah	9037320000	1,45 TL	100
H10,0/24 ZH EB	Fildişi	9037340000	1,70 TL	100
H16,0/29 ZH GN	Yeşil	9037360000	2,09 TL	50

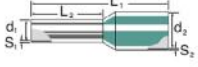

HO,5/14 OR BD

Tip	Renk	Sipariş No	Fiyat/Birim	Ambalaj
İzoleli Şerit Yüksükler (Stripax Plus için)				
H0,5/14 OR BD	Turuncu	9004270000	0,212 TL	500
H0,75/14 W BD	Beyaz	9004290000	0,212 TL	500
H1,0/14 GE BD	Sarı	9004320000	0,212 TL	500
H1,5/14 R BD	Kırmızı	9004340000	0,212 TL	500
H2,5/14D BL BD	Mavi	9004360000	0,289 TL	500

Tip	Renk	Sipariş No	Fiyat/Birim	Ambalaj
İzoleli Makara Şerit Yüksükler (Otomatik Makinalar için)				
H0,5/14 OR BD GSP	Turuncu	9005810000	0,292 TL	5000
H0,75/14 W BD GSP	Beyaz	9005820000	0,292 TL	5000
H1,0/14 GE BD GSP	Yeşil	9005830000	0,292 TL	5000
H1,5/14 R BD GSP	Kırmızı	9005840000	0,292 TL	5000
H2,5/14D BL BD GSP	Mavi	9005850000	0,325 TL	3000
H0,5/14D W BD GSP	Beyaz	9005860000	0,292 TL	5000
H0,75/14D GR	gri	9005870000	0,292 TL	5000
H1,0/14D R BD GSP	Kırmızı	9005880000	0,292 TL	5000
H1,5/14D SW BD GSP	Siyah	9005890000	0,292 TL	5000
H0,75/14T BL BD GSP	Mavi	9005900000	0,292 TL	5000
H2,5/14T GR BD GSP	Gri	9005910000	0,325 TL	3000

Tip	Ölçü	Sipariş No	Fiyat/Birim	Ambalaj
-----	------	------------	-------------	---------

İzoleli Kablo Pabuçları

Yuvarlak Uçlu Kablo Pabuçları

LIR 1,5M3 V	0.5 - 1.5 mm ²	9200070000	0,600 TL	100
LIR 1,5M3,5 V	0.5 - 1.5 mm ²	9200080000	0,600 TL	100
LIR 1,5M4 V	0.5 - 1.5 mm ²	9200090000	0,726 TL	100
LIR 1,5M5 V	0.5 - 1.5 mm ²	9200100000	0,700 TL	100
LIR 1,5M6 V	0.5 - 1.5 mm ²	9200110000	1,10 TL	100
LIR 2,5M3 V	1.5 - 2.5 mm ²	9200150000	0,740 TL	100
LIR 2,5M4 V	1.5 - 2.5 mm ²	9200170000	0,889 TL	100
LIR 2,5M5 V	1.5 - 2.5 mm ²	9200180000	0,889 TL	100
LIR 2,5M6 V	1.5 - 2.5 mm ²	9200190000	1,18 TL	100
LIR 2,5M8 V	1.5 - 2.5 mm ²	9200200000	1,20 TL	100
LIR 6M4 V	4.0 - 6.0 mm ²	9200230000	1,57 TL	100
LIR 6M5 V	4.0 - 6.0 mm ²	9200240000	1,56 TL	100
LIR 6M6 V	4.0 - 6.0 mm ²	9200250000	1,80 TL	100
LIR 6M8 V	4.0 - 6.0 mm ²	9200260000	2,17 TL	100

Çatal Uçlu Kablo Pabuçları

LIS 1,5M3 V	0.5 - 1.5 mm ²	9200290000	0,680 TL	100
LIS 1,5M3,5 V	0.5 - 1.5 mm ²	9200300000	0,700 TL	100
LIS 1,5M4 V	0.5 - 1.5 mm ²	9200310000	0,701 TL	100
LIS 1,5M5 V	0.5 - 1.5 mm ²	9200320000	0,800 TL	100
LIS 1,5M6 V	0.5 - 1.5 mm ²	9200330000	1,13 TL	100
LIS 2,5M3,5 V	1.5 - 2.5 mm ²	9200360000	0,850 TL	100
LIS 2,5M4 V	1.5 - 2.5 mm ²	9200370000	0,815 TL	100
LIS 2,5M5 V	1.5 - 2.5 mm ²	9200380000	0,880 TL	100
LIS 2,5M6 V	1.5 - 2.5 mm ²	9200390000	1,20 TL	100
LIS 6M4 V	4.0 - 6.0 mm ²	9200410000	1,50 TL	100
LIS 6M5 V	4.0 - 6.0 mm ²	9200420000	1,58 TL	100
LIS 6M6 V	4.0 - 6.0 mm ²	9200430000	1,90 TL	100
LIS 6M8 V	4.0 - 6.0 mm ²	9200440000	2,52 TL	100



LIR 1,5M3 V



LIS 1,5M3 V



LIP 1,5R12 V



LIF 1,5F638 R



LIB 1,5B25 VF

Tip	Ölçü	Sipariş No	Fiyat/Birim	Ambalaj
-----	------	------------	-------------	---------

İğne Uçlu Kablo Pabuçları

LIP 1,5R12 V	0.5 - 1.5 mm ²	9200460000	0,834 TL	100
LIP 2,5R12 V	1.5 - 2.5 mm ²	9200470000	1,02 TL	100
LIP 6R14 V	4.0 - 6.0 mm ²	9200480000	1,95 TL	100

Faston Kablo Pabuçları

LIF 1,5F638 R	0.5 - 1.5 mm ²	9200540000	0,896 TL	100
LIF 2,5F638 R	1.5 - 2.5 mm ²	9200560000	0,972 TL	100
LIF 6F638 R	4.0 - 6.0 mm ²	9200570000	1,36 TL	100
LIF 1,5M638 R	0.5 - 1.5 mm ²	9200580000	0,900 TL	100
LIF 2,5M638 R	1.5 - 2.5 mm ²	9200590000	0,923 TL	100
LIF 6M638 R	4.0 - 6.0 mm ²	9200600000	1,28 TL	100
LIF 1,5F638 RF	0.5 - 1.5 mm ²	9200640000	0,972 TL	100
LIF 2,5F638 RF	1.5 - 2.5 mm ²	9200650000	1,05 TL	100
LIF 6F638 RF	4.0 - 6.0 mm ²	9200660000	1,63 TL	100

Tip	Sipariş No	Fiyat/Birim	Ambalaj
-----	------------	-------------	---------

İzoleli Kablo Pabuçları**Ek Muf**

LIB 1,5B25 VF	9200490000	0,900 TL	100
LIB 2,5B25 VF	9200500000	1,00 TL	100
LIB 6B26 VF	9200510000	1,70 TL	100

Yüksükler ve Pabuçlar

Tip		AWG	Renk kodları/sipariş no:			Manuel Aletler					Soyma ve Sıkma makinaları	
mm ²	L2	AWG	Weidmüller	DIN	Çeşitli	Weidmüller	PZ 6 Roto / PZ 6 Roto L	PZ 6/5	PZ 3	PZ 16	CA 100 serisi	CRIMPRIX serisi
0.25	6	24	9025740000		9021010000							
0.25	8	24	9025760000		9021020000							
0.34	6	22	9025750000									
0.34	8	22	9025770000									
0.50	6	20	0409500000	9019000000								
0.50	8	20	0690700000	9019010000								
0.50	10	20	9025870000	9019020000								
0.75	6	18	0409600000	9019020000	9021030000							
0.75	8	18	0462900000	9019040000	9021040000							
0.75	10	18	9025860000	9019050000	9021050000							
0.75	12	18	9025910000	9019060000	9021060000							
1.00	6	18	0409700000	9019070000								
1.00	8	18	0463000000	9019080000								
1.00	10	18	9025950000	9019100000								
1.00	12	18	9025930000	9019110000								
1.5	6	16	9025960000									
1.5	8	16	0463100000	9019120000								
1.5	10	16	0635100000	9019130000								
1.5	12	16		9019140000								
1.5	18	16	0565600000	9019150000								
2.5	6	14		9028490000	9036200000							
2.5	8	14		9019160000	9021070000							
2.5	10	14		9036220000	9036210000							
2.5	12	14		9019170000	9021080000							
2.5	18	14		9019180000	9021090000							
4	8	12		9028520000	9036230000							
4	10	12		9019190000	9021100000							
4	12	12		9019200000	9021110000							
4	18	12		9019210000	9021120000							
6	12	10	0533500000	9019220000	9021130000							
6	18	10	0565700000	9019230000	9021140000							
10	12	8	0534200000	9019240000	9021150000							
10	18	8	0565800000	9019250000	9021160000							
16	12	6	0565900000	9019260000	9021170000							
16	18	6	0566000000	9019270000	9021180000							



CD 80x60 4/6

Tip	Yükseklik x Genişlik	Sipariş No	Fiyat/Birim	Ambalaj
Kablo Kanalları				
CD 30x25 4/6	30X25 cm	2589110000	24,00 TL	80M
CD 40x25 4/6	40X25 cm	2589130000	27,00 TL	60M
CD 60x25 4/6	60X25 cm	2589150000	39,00 TL	40M
CD 80x25 4/6	80X25 cm	2589180000	56,00 TL	32M
CD 40x40 4/6	40X40 cm	2589210000	36,00 TL	40M
CD 60x40 4/6	60X40 cm	2589230000	47,00 TL	36M
CD 80x40 4/6	80X40 cm	2589240000	64,00 TL	24M
CD 100x40 4/6	100X40 cm	2589260000	80,00 TL	16M
CD 40x60 4/6	40X60 cm	2589280000	45,00 TL	24M
CD 60x60 4/6	60X60 cm	2589300000	56,00 TL	24M
CD 80x60 4/6	80X60 cm	2589310000	70,00 TL	24M
CD 100x60 4/6	100X60 cm	2589330000	106,00 TL	16M
CD 60x80 4/6	60X80 cm	2589370000	68,00 TL	24M
CD 80x80 4/6	80X80 cm	2589380000	88,00 TL	24M
CD 100x80 4/6	100X80 cm	2589400000	115,00 TL	16M
CD 60x100 4/6	60X100 cm	2589420000	85,00 TL	20M
CD 80x100 4/6	80X100 cm	2589440000	106,00 TL	16M
CD 100x100 4/6	100X100 cm	2589450000	192,00 TL	16M
CD 60x120 4/6	60X120 cm	2589470000	128,45 TL	16M
CD-BO 80X120 4/6 GY	80X120 cm	2589490000	137,00 TL	16M
CD-LID 25	25 cm - Kapak	2590110000	16,15 TL	2M
CD-LID 40	40 cm - Kapak	2590080000	28,20 TL	2M
CD-LID 60	60 cm - Kapak	2590050000	55,10 TL	2M
CD-LID 80	80 cm - Kapak	2590020000	64,50 TL	2M
CD-LID 100	100 cm - Kapak	2590000000	73,90 TL	2M
CD-LID 120	120 cm - Kapak	2589990000	90,00 TL	2M
CD 100x40 8/12	100X40 cm	2588630000	94,00 TL	16M
CD 100x60 8/12 GY	100X60 cm	2588720000	116,25 TL	16M
CD-BO 100X80 8/12 GY	100X80 cm	2588790000	134,30 TL	16M
CD 100x100 8/12	100X100 cm	2588850000	186,50 TL	16M
CD 40x25 8/12	40X25 cm	2588460000	34,75 TL	60M
CD 40x40 8/12	40X40 cm	2588580000	44,15 TL	40M
CD 80x80 8/12	80X80 cm	2588770000	123,05 TL	24M

Not: Halojen-free kablo kanallarımız mevcuttur, detaylı bilgi için bölge satış temsilcimizle iletişime geçebilirsiniz.



TS35 x 7,5

Tip	Açıklama	Sipariş No	Fiyat/Birim	Ambalaj
İthal Raylar				
TS35 x 7,5	Çelik Deliksiz Ray (Sipariş şekli: 40 mt ve katları)	7730000011	27,55 TL	40M
TS32	Çelik Deliksiz Ray	7730000012	56,45 TL	20M
TS35 x 7,5 D	Çelik Delikli Ray (Sipariş şekli: 40 mt ve katları)	7730000013	31,90 TL	40M
TS32 D	Çelik Delikli Ray	7730000014	65,10 TL	20M
TS 35X15	Çelik Deliksiz Ray	7730000490	70,15 TL	20M
TS 35X15 D	Çelik Delikli Ray	7730000458	64,00 TL	20M
Orijinal Weidmüller Raylar				
TS 35X7.5 2M/ST/ZN	Çelik Deliksiz Ray	0383400000	57,00 TL	2M
TS 35X7.5/LL 2M/ST/ZN	Çelik Delikli Ray (Sipariş şekli: 40 mt ve katları)	0514500000	61,44 TL	40M
TS 35X15 2M/ST/ZN	Çelik Deliksiz Ray (Sipariş şekli: 20 mt ve katları)	0236400000	102,66 TL	20M
TS 35X15/LL 2M/ST/ZN	Çelik Delikli Ray (Sipariş şekli: 20 mt ve katları)	0236500000	105,18 TL	20M
TS 32X15 2M/ST/ZN	Çelik Deliksiz Ray	0122800000	85,80 TL	2M
TS 32X15/LL 2M/ST/ZN	Çelik Delikli Ray	0514400000	107,64 TL	2M
TS 15X5 2M/ST/ZN	Çelik Deliksiz Ray	0514200000	52,62 TL	2M
TS 15X5/LL 2M/ST/ZN	Çelik Delikli Ray	0117500000	44,00 TL	2M



TSTW 5/M5



Schuko TS35



RACCORDO 50

Tip	Açıklama	Sipariş No	Fiyat/Birim	Ambalaj
Ray Taşıyıcı				
TSTW 5/M5	M5 Ray Montaj Ayağı	0178100000	21,84 TL	10
TSTW 6/M6	M6 Ray Montaj Ayağı	0164000000	21,84 TL	10
SH 2	TS 32 ve TS 35 İçin	0494920000	47,52 TL	10

TS 35 Raya Montaj Tek Fazlı Priz				
Schuko TS35	Ray Prizi	8734580000	14,00 €	10

Tip	Sipariş No	Fiyat/Birim	Ambalaj
Spiral Hortumlar			
FLEX. D8	7730000459	8,00 TL	30
FLEX. D10	7730000015	8,20 TL	30M
FLEX. D12	7730000016	9,00 TL	30M
FLEX. D14	7730000017	11,00 TL	30M
FLEX. D16	7730000018	12,00 TL	30M
FLEX. D20	7730000019	14,00 TL	30M
FLEX. D22	7730000020	15,00 TL	30M
FLEX. D25	7730000409	17,00 TL	30M
FLEX. D28	7730000021	24,00 TL	30M
FLEX. D32	7730000022	26,00 TL	30M
FLEX. D35	7730000023	30,00 TL	30M
FLEX. D40	7730000460	36,00 TL	30M
FLEX. D50	7730000025	52,00 TL	30M
FLEX. D60	7730000461	57,00 TL	30

Rakorlar				
RACCORDO 10 1/2	7730000026	10,00 TL	50	
RACCORDO 12-3/8	7730000027	10,00 TL	50	
RACCORDO 14-1/2	7730000028	11,00 TL	50	
RACCORDO 16-1/2	7730000029	12,00 TL	50	
RACCORDO 20	7730000031	13,20 TL	50	
RACCORDO 22-3/4	7730000032	14,00 TL	50	
RACCORDO 28-1	7730000033	19,00 TL	25	
RACCORDO 32	7730000489	21,00 TL	25	
RACCORDO 35	7730000035	24,00 TL	20	
RACCORDO 40-1/2	7730000481	35,00 TL	15	
RACCORDO 50	7730000037	47,00 TL	10	



IE-FC-SFM-KNOB



IE-FC-SP-PWB/2ST



IE-FC-SP-PWS/2ST/1D9



IE-BI-RJ45-FJ-A



IE-BI-USB-A



IE-FCI-D9-FM



IE-FCI-PWB-DE

Tip	Açıklama	Sipariş No	Fiyat/Birim	Ambalaj
IP 65 Koruma Kapakları				
IE-FC-SFM-KNOB	Metal hazne, butonlu ön kapak	1450530000	40,65 €	1
IE-FC-SFM-KEY	Metal hazne, kilitli ön kapak	1450540000	53,85 €	1
IE-FC-SFP-KNOB	Plastik hazne, butonlu ön kapak	1450510000	38,00 €	1
IE-FC-SFP-KEY	Plastik hazne, kilitli ön kapak	1450520000	56,00 €	1
IE-FC-DFM-KNOB	Çiftli Metal hazne, butonlu ön kapak	2003170000	59,05 €	1
IE-FC-DFM-KEY	Çiftli Metal hazne, kilitli ön kapak	2003180000	72,05 €	1
IE-FC-DFM-CAB	Çiftli Metal hazne, kabin kilitli ön kapak	2003190000	59,05 €	1
IE-FC-DFM-CAB-DB	Çiftli Metal hazne, kabin kilitli ön kapak (Daimler)	2003150000	59,05 €	1
IP 20 İç Montaj Plakaları				
IE-FC-SP-PWB/2ST	1x Enerji, 2x Data, izoleli, shielding	1450550000	30,00 €	1
IE-FC-IP-PWB/2ST	1x Enerji, 2x Data, izolesiz	1450630000	16,00 €	1
IE-FC-SP-PWS/2ST/1D9	1x Enerji, 2x Data, 1x Sinyal, izoleli, shielding	1450600000	28,35 €	1
IE-FC-IP-PWS/2ST/1D9	1x Enerji, 2x Data, 1x Sinyal, izolesiz	1450690000	12,55 €	1
IE-FC-SP-PWS/4ST	1x Enerji, 4x Data, izoleli, shielding	1450570000	28,35 €	1
IE-FC-IP-PWS/4ST	1x Enerji, 4x Data, izolesiz	1450640000	12,55 €	1
IE-FC-SP-PWS/2D9	1x Enerji, 2x Sinyal, izoleli, shielding	1450610000	28,35 €	1
IE-FC-IP-PWS/2D9	1x Enerji, 2x Sinyal, izolesiz	1450680000	12,55 €	1
IE-FC-SP-PWU/2ST	1x Enerji, 2x Data, izoleli, shielding	1450620000	28,35 €	1
IE-FC-IP-PWU/2ST	1x Enerji, 2x Data, izolesiz	1450700000	12,55 €	1
IE-FC-SP-2ST/2D9	2x Data, 2x Sinyal, izoleli, shielding	1450590000	28,35 €	1
IE-FC-IP-2ST/2D9	2x Data, 2x Sinyal, izolesiz	1450670000	12,55 €	1
IE-FC-SP-1ST/1D9/1D25	1x Data, 2x Sinyal, izoleli, shielding	1450580000	28,35 €	1
IE-FC-IP-1ST/1D9/1D25	1x Data, 2x Sinyal, izolesiz	1450650000	12,55 €	1
IP 20 Double İç Montaj Plakaları				
IE-FC-DSP-CI/3A/2ST/1D9	1x GFCl, 1x Sigorta, 2x Data, 1x Sinyal, izoleli	2004810000	76,85 €	1
IE-FC-DIP-CI/3A/2ST/1D9	1x GFCl, 1x Sigorta, 2x Data, 1x Sinyal, izolesiz	2003370000	61,15 €	1
IE-FC-DSP-PWB/2ST/FILS	1x Güç, 2x Data, 1x LS Switch, izoleli	2067080000	33,90 €	1
IE-FC-DIP-PWB/2ST/FILS	1x Güç, 2x Data, 1x LS Switch, izolesiz	2067070000	18,10 €	1
IE-FC-DIP-BP	İzolesiz plaka	2004890000	16,70 €	1
RJ 45 Modülleri				
IE-BI-RJ45-FJ-A	TIA-A. Cat. 6A	1962850000	19,50 €	10
IE-BI-RJ45-FJ-B	TIA-B. Cat. 6A	1963840000	19,50 €	10
IE-BI-RJ45-FJ-P	RJ45 Soket, Profinet	1963830000	22,00 €	1
IE-BI-RJ45-C	Çift taraflı RJ45 dişi soket	1962840000	20,00 €	1
USB Modülleri				
IE-BI-USB-A	USB A/A 2.0	1019570000	13,10 €	10
IE-BI-USB-3.0-A	USB A/A 3.0	1487920000	25,00 €	1
IE-BI-USB-AB	USB A/B 2.0	1131380000	13,00 €	1
D-Sub Modülleri				
9-Pole				
IE-FCI-D9-FF	Dişi - Dişi	1450840000	5,95 €	1
IE-FCI-D9-FM	Dişi - Erkek	1450850000	5,95 €	1
IE-FCI-D9-FS	Dişi - Lehim Bağlantısı	1450870000	5,20 €	1
25-Pole				
IE-FCI-D25-FF	Dişi - Dişi	1450880000	7,65 €	1
IE-FCI-D25-FM	Dişi - Erkek	1450890000	7,65 €	1
IE-FCI-D25-FS	Dişi - Lehim Bağlantısı	1450900000	8,00 €	1
Priz				
IE-FCI-PWB-DE	IP 20 250V 16 A, Alman Standartı	1450730000	20,00 €	1
IE-FCI-PWB-GB	IP 20 250V 16 A, Fransız Standardı	1450770000	20,55 €	1
IE-FCI-PWB-RCBO	230V AC 16A	1534250000	136,00 €	1

Tip	Nom. V / Nom A	Aydınlatma Seviyesi / Işık Rengi (CCT) / Uzunluk	Sipariş No	Fiyat/Birim	Ambalaj
Pano İçi LED Aydınlatma Ürünleri					
Vida ile Pano Montajlı					
WIL-STANDARD-0.3-SCREW-SW-WHI	24 V DC / 420 mA	140 lux / 6500K, White / 240mm	2436210000	175,00 €	1
WIL-STANDARD-0.3-SCREW-SW-RED	24 V DC / 360 mA	70 lux / Red / 240mm	2436340000	300,00 €	1
WIL-STANDARD-0.3-SCREW-SW-BLU	24 V DC / 360 mA	135 lux / Blue / 240mm	2436350000	255,00 €	1
WIL-STANDARD-1.5-SCREW-SW-WH	24 V DC / 420 mA	140 lux / 6500K, White / 240mm	2527880000	173,00 €	1
WIL-STANDARD-3.0-SCREW-SW-WHI	24 V DC / 420 mA	140 lux / 6500K, White / 240mm	2527890000	180,00 €	1
WIL-STANDARD-5.0-SCREW-SW-WHI	24 V DC / 420 mA	140 lux / 6500K, White / 240mm	2527900000	191,00 €	1
WIL-STANDARD-10-SCREW-SW-WHI	24 V DC / 420 mA	140 lux / 6500K, White / 240mm	2527910000	222,00 €	1
Mıknatıs ile Pano Montajlı					
WIL-STANDARD-1.5-MAG-SW-WHI	24 V DC / 420 mA	140 lux / 6500K, White / 240mm	2527920000	197,00 €	1
WIL-STANDARD-10-MAG-SW-WHI	24 V DC / 420 mA	140 lux / 6500K, White / 240mm	2527950000	249,00 €	1
WIL-STANDARD-3.0-MAG-SW-WHI	24 V DC / 420 mA	140 lux / 6500K, White / 240mm	2527930000	209,00 €	1
WIL-STANDARD-5.0-MAG-SW-WHI	24 V DC / 420 mA	140 lux / 6500K, White / 240mm	2527940000	219,00 €	1
WIL Uzunluk Varyantı					
WIL-145-W-M12G-0.3U-S	24 V DC / 210 mA	140 lux / 6500K, White / 145mm	2535770000	131,00 €	1
WIL-350-W-M12G-0.3U-S	24 V DC / 630 mA	140 lux / 6500K, White / 350mm	2535810000	222,00 €	1
WIL-450-W-M12G-0.3U-S	24 V DC / 840 mA	140 lux / 6500K, White / 450mm	2535830000	286,00 €	1
WIL-555-W-M12G-0.3U-S	24 V DC / 1050 mA	140 lux / 6500K, White / 555mm	2535850000	353,00 €	1
WIL-655-W-M12G-0.3U-S	24 V DC / 1260 mA	140 lux / 6500K, White / 655mm	2535870000	420,00 €	1
WIL-765-W-M12G-0.3U-S	24 V DC / 1470 mA	140 lux / 6500K, White / 765mm	2535890000	509,00 €	1
WIL-860-W-M12G-0.3U-S	24 V DC / 1680 mA	140 lux / 6500K, White / 860 mm	2535910000	553,00 €	1
Aksesuarlar					
WIL-MAGNET			2526810000	29,95 €	1



WIL-STANDARD-10-MAG-SW-WHI



CB 98/2.5 BLACK

Tip	Renk	Sipariş No	Fiyat/Birim	Ambalaj
Kablo Bağları				
* CB 98/2.5 NATUR	Beyaz	1278600000	0,070 TL	100
* CB 98/2.5 BLACK	Siyah	1697890000	0,070 TL	100
CB 135/2.5 NATUR	Beyaz	7940006040	0,130 TL	100
CB 135/2.5 BLACK	Siyah	7940006047	0,130 TL	100
CB 200/2.6 NATUR	Beyaz	7940006050	0,146 TL	100
CB 200/2.6 BLACK	Siyah	7940006051	0,146 TL	100
CB 140/3.5 NATUR	Beyaz	1278700000	0,160 TL	100
CB 140/3.5 BLACK	Siyah	1697900000	0,160 TL	100
CB 200/3.5 NATUR	Beyaz	1720630000	0,206 TL	100
CB 200/3.5 BLACK	Siyah	1720660000	0,206 TL	100
CB 290/3.5 NATUR	Beyaz	1720640000	0,301 TL	100
CB 290/3.5 BLACK	Siyah	1720650000	0,301 TL	100
CB 370/3.5 NATUR	Beyaz	7940006056	0,660 TL	100
CB 370/3.5 BLACK	Siyah	7940006057	0,660 TL	100
CB 200/4.8 NATUR	Beyaz	1278800000	0,300 TL	100
CB 200/4.8 BLACK	Siyah	1697910000	0,300 TL	100
CB 160/4.5 NATUR	Beyaz	1723540000	0,307 TL	100
CB 160/4.5 BLACK	Siyah	1723560000	0,307 TL	100
CB 178/4.8 NATUR	Beyaz	1723550000	0,311 TL	100
CB 178/4.8 BLACK	Siyah	1723570000	0,311 TL	100
CB 290/4.5 NATUR	Beyaz	1278900000	0,427 TL	100
CB 290/4.5 BLACK	Siyah	1697920000	0,427 TL	100
CB 360/4.5 NATUR	Beyaz	1279000000	0,530 TL	100
CB 360/4.5 BLACK	Siyah	1697930000	0,530 TL	100
CB 180/7.8 NATUR	Beyaz	7940006064	0,625 TL	100
CB 180/7.8 BLACK	Siyah	7940006065	0,625 TL	100
CB 300/7.8 NATUR	Beyaz	7940006068	0,900 TL	100
CB 300/7.8 BLACK	Siyah	7940006069	0,900 TL	100
CB 365/7.5 NATUR	Beyaz	1279100000	1,14 TL	100
CB 365/7.5 BLACK	Siyah	1697940000	1,14 TL	100
CB 450/7.5 NATUR	Beyaz	7940006070	1,60 TL	100
CB 450/7.5 BLACK	Siyah	7940006071	1,60 TL	100
CB 540/7.5 NATUR	Beyaz	7940006072	1,81 TL	100
CB 540/7.5 BLACK	Siyah	7940006073	1,81 TL	100
CB 750/7.5 NATUR	Beyaz	1720680000	2,64 TL	100
CB 750/7.5 BLACK	Siyah	1720670000	2,64 TL	100
CB 780/9.0 NATUR	Beyaz	7940006074	5,40 TL	100
CB 780/9.0 BLACK	Siyah	7940006075	5,40 TL	100
CBH 19/19 NATUR	Kablo Bağı Taşıyıcı	1289200000	0,700 TL	100
CBH 27/27 NATUR	Kablo Bağı Taşıyıcı	1289400000	0,900 TL	100



SCT 4,6/127 C

Tip	Sipariş No	Fiyat/Birim	Ambalaj
Paslanmaz Çelik Kablo Bağları			
SCT 4,6/127 C	1699800000	0,95 €	100
SCT 4,6/201 C	1699810000	1,25 €	100
SCT 4,6/266C	1699900000	1,20 €	100
SCT 4,6/360 C	1699910000	1,50 €	100
SCT 4,6/520	1699920000	1,55 €	100
SCT 4,6/679	1699930000	2,25 €	100
SCT 4,6/838	1699940000	2,75 €	100



SCT-C 4.6/100

Tip	Sipariş No	Fiyat/Birim	Ambalaj
Yüzeyi Tam Kaplamalı İzoleli Paslanmaz Çelik Kablo Bağları			
SCT-C 4.6/100	1015220000	0,95 €	100
SCT-C 4.6/125	1015230000	1,05 €	100
SCT-C 4.6/150	1015240000	1,05 €	100
SCT-C 4.6/200	1015250000	1,30 €	100
SCT-C 4.6/360	1015270000	1,45 €	100
SCT-C 4.6/520	1015280000	1,70 €	100
SCT-C 4.6/680	1015290000	2,10 €	100
SCT-C 4.6/840	1015300000	2,40 €	100
SCT-C 7.9/200	1015310000	1,40 €	100
SCT-C 7.9/360	1015320000	1,60 €	100
SCT-C 7.9/520	1015330000	2,50 €	100
SCT-C 7.9/680	1015340000	2,45 €	100
SCT-C 7.9/840	1015350000	2,80 €	100



CB-VT 98/2.5 HF/VO WT

Tip	Dayanım Kuvveti / Malzeme	Sipariş No	Fiyat/Birim	Ambalaj
Raylı Sistemler ve Robotik Uygulamalar için Kablo Bağları				
* CB-VT 98/2.5 HF/VO WT	80 N / Halojen free	2659490000	0,540 TL	100
* CB-VT 140/3.5 HF/VO WT	150 N / Halojen free	2659500000	0,884 TL	100
* CB-VT 200/3.5 HF/VO WT	150 N / Halojen free	2659510000	1,27 TL	100
* CB-VT 200/4.5 HF/VO WT	220 N / Halojen free	2659520000	1,37 TL	100
* CB-VT 290/4.5 HF/VO WT	220 N / Halojen free	2659530000	2,94 TL	100
* CB-VT 365/7.5 HF/VO WT	540 N / Halojen free	2659540000	4,44 TL	100



CB-HTR 98/2.5

Tip	Renk	Sipariş No	Fiyat/Birim	Ambalaj
Yüksek Sıcaklık Uygulamaları (+125 °C Dereceye kadar)				
* CB-HTR 98/2.5	Beyaz	2659430000	0,600 TL	100
* CB-HTR 98/2.5	Siyah	2659370000	0,600 TL	100
* CB-HTR 140/3.5	Beyaz	2659440000	0,884 TL	100
* CB-HTR 140/3.5	Siyah	2659380000	0,751 TL	100
* CB-HTR 200/3.5	Beyaz	2659450000	1,27 TL	100
* CB-HTR 200/3.5	Siyah	2659390000	1,28 TL	100
* CB-HTR 200/4.5	Beyaz	2659460000	1,37 TL	100
* CB-HTR 200/4.5	Siyah	2659400000	1,37 TL	100
* CB-HTR 290/4.5	Beyaz	2659470000	2,94 TL	100
* CB-HTR 290/4.5	Siyah	2659410000	2,94 TL	100
* CB-HTR 365/7.5	Beyaz	2659480000	4,44 TL	100
* CB-HTR 365/7.5	Siyah	2659420000	4,44 TL	100



CB-DT 100/2.5 BL

Tip	Dayanım Kuvveti / Malzeme	Sipariş No	Fiyat/Birim	Ambalaj
Açık Alan Uygulamaları (UV ISO-4892-2A, DNV-GL)				
* CB-UVR 98/2.5 BK	80 N / Halojen free	2659310000	0,600 TL	100
* CB-UVR 140/3.5 BK	150 N / Halojen free	2659320000	0,884 TL	100
* CB-UVR 200/3.5 BK	150 N / Halojen free	2659330000	1,30 TL	100
* CB-UVR 200/4.5 BK	220 N / Halojen free	2659340000	1,63 TL	100
* CB-UVR 290/4.5 BK	220 N / Halojen free	2659350000	2,94 TL	100
* CB-UVR 365/7.5 BK	540 N / Halojen free	2659360000	4,44 TL	100
Detectable(Algılanabilir) Kablo Bağları				
* CB-DT 100/2.5 BL	80 N / Halojen free	2602750000	1,07 TL	100
* CB-DT 140/3.5 BL	150 N / Halojen free	2602760000	2,38 TL	100
* CB-DT 200/4.5 BL	150 N / Halojen free	2602770000	2,76 TL	100
* CB-DT 280/4.5 BL	220 N / Halojen free	2602780000	5,94 TL	100
* CB-DT 380/4.5 BL	220 N / Halojen free	2602790000	7,38 TL	100
* CB-DT 360/7.5 BL	540 N / Halojen free	2602800000	13,10 TL	100

u-mation Otomasyon Ürün Grubu

Weidmüller u-mation ürün ailesi geleceğin akıllı makineleri ve tesisleri için mükemmel bir şekilde koordine edilmiş ürün portföyü sunar. Endüstri 4.0 ve Sensörden Buluta Endüstriyel Haberleşme ilkesine bağlı olarak geliştirilen u-mation ailesi platform bağımsız, hızlı entegrasyon, esnek yapısıyla kullanıcılarına benzersiz deneyim sunmaktadır.

u-control 2000 piyasadaki en modern ve kompakt PLC'lerden biridir ve mühendislik ortamlarınız için mükemmel çözümler sunmaktadır. Yaratıcı Nesnelerin İnterneti (IoT) ve otomasyon projeleriniz için geliştirilmiş olan u-control 2000; modüler tasarımı sayesinde 100'den fazla u-remote I/O modülü ile genişleme imkânı sağlamaktadır. IEC 61131-3 standartlarına uyumlu olarak CODESYS veya web tabanlı programlama platformları sistemlerinize mükemmel avantajlar kazandırır.

u-remote IP20 ve IP67 uzak I/O sistemi hızlı ve pratik kurulumun yanı sıra sistemin güvenli şekilde başlatılması ve arıza sebepli duruşların minimize edilmesi açısından uygulamalara yönelik tam uyumlu çözümler sunmaktadır. İnce modül dizaynı ve modül beslemelerinde daha az güç kaynağı ihtiyacı duyan teknolojisi ile pano içinde az yer kaplayarak pano tasarımlarını küçültür. Çeşitli bus protokollerini destekleyebilen akıllı modülleri ile IP 67 remote I/O modülleri interface kartlar yardımı ile IP 20 I/O grupları ile aynı sistem içerisinde pratik bir şekilde kullanılabilir.

u-view HMI ve Endüstriyel PC ürünleri sistemlerinizin izlenmesi ve kontrolü için mükemmel görselleştirme imkanı sunmaktadır. u-view HMI portföyünü oluşturan kapasitif ve rezistif dokunmatik ekranlar; web teknolojilerini destekleyen işletim sistemi ile birlikte donanımsal ve yazılımsal bağımsızlık sağlamaktadır. u-view IPC ürünleri gamında bulunan Box PC, Panel PC ve Monitörler; kompakt ve güçlü donanım yapısı ile tesislerinizde ve otomasyon sistemlerinizde maksimum performans ve gücü garanti etmektedir.





UC20-WL2000-AC



UR20-FBC-PB-DP-V2



UR20-FBC-EC



UR20-4DI-2W-230V-AC



UR20-8DI-2W-230V-AC



UR20-2DI-P-TS



UR20-4DO-P-2A

Tip	Açıklama	Sipariş No	Fiyat/Birim	Ambalaj
u-control 2000 PLC Serisi				
* UC20-WL2000-AC	Web tabanlı Programlama	1334950000	580,00 €	1
* UC20-SL2000-OLAC-EC	Codesys Tabanlı PLC, EtherCAT protokolüne sahip	2638920000	825,00 €	1
* UC20-WL2000-IOT	IOT Kontrolör	1334990000	600,00 €	1
u-remote I/O Modülleri				
Coupler Modülleri				
* UR20-FBC-PB-DP-V2	Profibus DP V2 Coupler	2614380000	390,00 €	1
* UR20-FBC-PN-IRT-V2	Profinet RT & IRT Coupler	2566380000	428,00 €	1
UR20-FBC-EC	EtherCAT Coupler	1334910000	369,00 €	1
UR20-FBC-CAN	CANopen Coupler	1334890000	405,00 €	1
UR20-FBC-EIP	Ethernet/IP Coupler	1334920000	410,00 €	1
UR20-FBC-MOD-TCP-V2	Modbus TCP V2 Coupler (2 CPU ile senkronize ayrı network hatları üzerinden haberleşme)	2476450000	430,00 €	1
UR20-FBC-PL	Powerlink Coupler	1334940000	400,00 €	1
UR20-FBC-DN	DeviceNet Coupler	1334900000	405,00 €	1
* UR20-FBC-IEC61162-450	Fieldbuscoupler IEC 61162-450	2661310000	580,00 €	1
Dijital Input Modülleri				
UR20-4DI-2W-230V-AC	4 DI Modülü 230V AC	1550070000	67,50 €	1
UR20-4DI-P	4 DI Modülü (2, 3, 3 + Toprak kablolu)	1315170000	45,00 €	1
UR20-4DI-P-3W	4 DI Modülü (2, 3 kablolu)	2009360000	45,00 €	1
UR20-4DI-N	4 DI Modülü Negatif Anahtarlama	1315350000	57,00 €	1
UR20-8DI-P-2W	8 DI Modülü (2 kablolu)	1315180000	68,00 €	1
UR20-8DI-P-3W	8 DI Modülü (2 ve 3 kablolu)	1394400000	70,00 €	1
UR20-8DI-N-3W	8 DI Modülü (2 ve 3 kablolu) Negatif Anahtarlama	1315370000	81,50 €	1
* UR20-8DI-HSO-2W	8 DI Modülü (500V'a kadar Galvanik İzolasyonlu)	2457240000	100,00 €	1
* UR20-8DIO-P-3W-DIAG	Dijital Input ya da Output Olarak Ayarlanabilir 8 Kanal Modül	2456530000	133,00 €	1
UR20-16DI-P	16 DI Modülü (1 kablolu)	1315200000	98,00 €	1
UR20-16DI-N	16 DI Modülü Negatif Anahtarlama	1315390000	109,00 €	1
UR20-16DI-P-PLC-INT	16 DI Modülü (PLC Interface)	1315210000	117,00 €	1
UR20-16DI-N-PLC-INT	16 DI Modülü (PLC Interface) Negatif Anahtarlama	1315400000	116,00 €	1
UR20-8DI-P-3W-HD	8 DI HD Modülü (8 konektör x 4 bağlantı noktası)(2 ve 3 kablolu)	1315190000	57,00 €	1
Time Stamp				
UR20-2DI-P-TS	2 DI Modülü (2, 3, 3 + Toprak kablolu) Time Stamp, Sensör ve Transmitter uygulamaları	1460140000	75,50 €	1
UR20-4DI-P-TS	4 DI Modülü (2, 3, 3 + Toprak kablolu) Time Stamp, Sensör ve Transmitter uygulamaları	1460150000	170,00 €	1
Dijital Output Modülleri				
UR20-4DO-P	4 DO Modülü (2, 3, 3 + Toprak kablolu) 0.5A/ kanal	1315220000	49,50 €	1
UR20-4DO-N	4 DO Modülü (2, 3, 3 + Toprak kablolu) 0.5A/ kanal, Negatif Anahtarlama	1315410000	63,00 €	1
* UR20-4DO-ISO-4A	4 DO Modülü (500V'a kadar Galvanik İzolasyonlu)	2457250000	Sorunuz	Sorunuz
UR20-4DO-P-2A	4 DO Modülü (2, 3, 3 + Toprak kablolu) 2A/ kanal	1315230000	80,00 €	1
UR20-4DO-PN-2A	4 DO Modülü (2, 3, 3 + Toprak kablolu) 2A/ kanal, Pozitif ve Negatif anahtarlama	1394420000	113,00 €	1
UR20-4DO-N-2A	4 DO Modülü (2, 3, 3 + Toprak kablolu) 2A/ kanal, Negatif anahtarlama	1315420000	95,00 €	1
UR20-8DO-N	8 DO Modülü Negatif Anahtarlama	1315430000	92,00 €	1
UR20-8DO-P	8 DO Modülü (2 kablolu) 0.5A/ kanal	1315240000	78,00 €	1
UR20-16DO-P	16 DO Modülü (1 kablolu) 0.5A/ kanal Pozitif Anahtarlama	1315250000	118,00 €	1
UR20-16DO-N	16 DO Modülü (1 kablolu) 0.5A/ kanal Negatif Anahtarlama	1315440000	120,00 €	1
UR20-16DO-P-PLC-INT	16 DO Modülü (PLC Interface) 0.5A/ kanal Pozitif Anahtarlama	1315270000	135,00 €	1
UR20-16DO-N-PLC-INT	16 DO Modülü (PLC Interface) 0.5A/ kanal Negatif Anahtarlama	1315450000	135,00 €	1
UR20-8DO-P-2W-HD	8 DO HD Modülü (2 kablolu) 0.5A/ kanal	1509830000	70,50 €	1



UR20-4RO-SSR-255



UR20-8AI-I-PLC-INT



UR20-8AI-16-DIAG-HD



UR20-1SM-50W-6DI-2DO-P



UR20-PF-0-2DI-SIL



UR20-2CNT-100



UR20-4AI-RTD-DIAG

Tip	Açıklama	Sipariş No	Fiyat/Birim	Ambalaj
Röle ve SS Röle Modülleri				
UR20-4RO-SSR-255	4 DO Solid State Röle 0.5A/ kontak	1315540000	127,00 €	1
UR20-4RO-CO-255	4 DO Change Over Röle 6A/ kontak 277V AC/DC	1315550000	120,00 €	1
Analog Input Modülleri				
Voltaj (0...5 V, ±5 V, 0...10 V, ±10 V, 1...5 V, 2...10 V), Akım (0...20 mA, 4...20 mA)				
UR20-4AI-UI-16	4 AI Modülü (2, 3, 3 + FE kablolu) 16 Bit	1315620000	225,00 €	1
UR20-4AI-UI-16-DIAG	4 AI Modülü (2, 3, 3 + FE kablolu) 16 Bit, diagnosis	1315690000	250,00 €	1
UR20-4AI-UI-16-HD	4 AI HD Modülü (2, 3, 3 + FE kablolu) 16 Bit	1506920000	225,00 €	1
UR20-4AI-UI-16-DIAG-HD	4 AI HD Modülü (2, 3, 3 + FE kablolu) 16 Bit, diagnosis	1506910000	250,00 €	1
UR20-4AI-UI-12	4 AI Modülü (2, 3, 3 + FE kablolu) 12 Bit	1394390000	200,00 €	1
Akım (0 - 20 mA, 4 - 20 mA)				
UR20-8AI-PLC-INT	8 AI Modülü (PLC Interface) 16 Bit	1315670000	235,00 €	1
UR20-8AI-16-HD	8 AI HD Modülü 16 Bit	1315650000	234,00 €	1
UR20-8AI-16-DIAG-HD	8 AI HD Modülü 16 Bit, diagnosis	1315720000	265,00 €	1
Analog Output Modülü				
Voltaj (0...5 V, ±5 V, 0...10 V, ±10 V, 1...5 V, 2...10 V), Akım (0...20 mA, 4...20mA)				
UR20-4AO-UI-16	4 AO Modülü (2 ve 4 kablolu) 16 Bit	1315680000	260,00 €	1
UR20-4AO-UI-16-DIAG	4 AO Modülü (2 ve 4 kablolu) 16 Bit, diagnosis	1315730000	285,00 €	1
UR20-4AO-UI-16-HD	4 AO HD Modülü (2 ve 4 kablolu) 16 Bit	1510690000	230,00 €	1
UR20-4AO-UI-16-DIAG-HD	4 AO HD Modülü (2 ve 4 kablolu) 16 Bit, diagnosis	1506930000	264,00 €	1
Not: HD modüllere ait olan konektörleri ayrı şekilde sipariş edilmelidir.				
Load Cell Modülü				
UR20-2AI-SG-24-DIAG	Load Cell modülü 2 kanal	1990070000	283,00 €	1
Step Motor Modülü				
* UR20-1SM-50W-6DI-2DO-P	6 DI (2 kanal Enkoder için) ve 2 DO (50W uygulamalara kadar)	2489830000	404,00 €	1
Enerji İzleme Modülü				
UR20-3EM-230V-AC	1 / 5 A 3 faz enerji izleme modülü (Aktif, reaktif güç, 31. Harmonik)	2007420000	250,00 €	1
SIL Güvenlik Röleleri				
UR20-PF-0-1DI-SIL	24V SIL 3 Güvenlik rölesi. Bir acil stop butonu için tek DI	1335030000	233,00 €	1
UR20-PF-0-2DI-DELAY-SIL	24V SIL 3 Güvenlik rölesi. 2 acil stop butonu için 2 DI	1335040000	267,00 €	1
UR20-PF-0-2DI-SIL	24V SIL 3 Güvenlik rölesi. 2 acil stop butonu için 2 DI ve SS çıkış, Geciktirme ayarlı	1335050000	260,00 €	1
Dijital Counter ve Pulse Modulation Modülleri				
UR20-1CNT-100-1DO	1 Kanal Dijital Counter Modülü 32Bit 100Khz, Reset, Digital Output	1315570000	180,00 €	1
UR20-1CNT-500	1 Kanal Dijital Counter Modülü 32Bit 500Khz, Reset	1315580000	205,00 €	1
UR20-2CNT-100	2 Kanal Dijital Counter Modülü 32Bit 100Khz	1315590000	210,00 €	1
UR20-2FCNT-100	2 Kanal Dijital Frekans Counter Modülü 32Bit 100Khz	1508080000	183,00 €	1
UR20-2PWM-PN-0.5A	2 kanal Pulse width Modulation Modülü 0.5A/ kanal Max 40 Khz	1315600000	210,00 €	1
UR20-2PWM-PN-2A	2 kanal Pulse width Modulation Modülü 2A/ kanal Max 40 Khz	1315610000	250,00 €	1
Serial Arayüz ve Interface Modülleri				
UR20-1SSI	RS422 (Synchronous serial interface), 125kHz - 2MHz	1508090000	230,00 €	1
UR20-1COM-232-485-422	RS232, RS485, RS422, 300 - 115.200 Bit/s, RS232 veya RS485/422 Interface	1315750000	250,00 €	1
UR20-1COM-SAI-PRO	IP67 Interface, 250 veya 500 kBit/s, SAI-PRO Subbus	2007430000	230,00 €	1
UR20-4COM-IO-LINK	4 Port I/O link interface modülü	1315740000	240,00 €	1
Sıcaklık Algılama Modülleri				
Sensör: Pt100, 200, 500, 1000; Ni100, 120, 200, 500, 1000; Cu10; 40 Ω - 4000 Ω aralık direnç giriş değeri				
UR20-4AI-RTD-DIAG	4 AI RTD Sensör Bağlantı Modülü (2, 3, 4 kablolu) 16 Bit	1315700000	222,00 €	1
* UR20-8AI-RTD-DIAG-2W	8 AI RTD Sensör Bağlantı Modülü 16 Bit	2555940000	265,00 €	1



UR20-16AUX-I



UR20-EBK-ACC



UR20-PG0.35

Tip	Açıklama	Sipariş No	Fiyat/Birim	Ambalaj
Sensör: J, K, T, B, N, E, R, S, L, U, C, mV				
UR20-4AI-TC-DIAG	4 AI TC Sensör Bağlantı Modülü 16 Bit	1315710000	234,00 €	1
Besleme Modülleri				
UR20-PF-I	Besleme Modülü 10A Input	1334710000	45,00 €	1
UR20-PF-O	Besleme Modülü 10A Output	1334740000	45,00 €	1
AUX Besleme ve Potansiyel Dağıtım Modülleri				
UR20-16AUX-I	Potansiyel Dağıtım Modülü Input	1334770000	32,50 €	1
UR20-16AUX-O	Potansiyel Dağıtım Modülü Output	1334780000	32,50 €	1
UR20-16AUX-FE	Potansiyel Dağıtım Modülü Toprak	1334790000	32,50 €	1
UR20-16AUX-GND-I	Potansiyel Dağıtım Modülü GND-I	1334800000	32,50 €	1
UR20-16AUX-GND-O	Potansiyel Dağıtım Modülü GND-O	1334810000	32,50 €	1
Pasif Modül				
UR20-ES	Boş Modül Yapısı	1315770000	27,00 €	1
Aksesuarlar				
UR20-EBK-ACC	Sonlandırma Plakaları	1346610000	12,00 €	5
DEK 5/8-11.5 MC NE WS	Modül Markalama	1341630000	0,902 TL	500
UR20-SM-ACC	Markalama Tutucu Aparat Opsiyonel	1339920000	1,50 €	20
UR20-PG0.35	HD Modüller için konektör	1469340000	9,50 €	8
Montaj Yardımcı Aparatları				
Multi-stripax 6-16	6, 10, 16 mm ² kesite sahip sert ve yumuşak izolasyonlu kablolar için	9202210000	5.126,00 TL	1
PWZ-UR20-HD		1525820000	2.087,00 TL	1

Not: HD modüllere ait olan konektörleri ayrı şekilde sipariş edilmelidir.



UR67-PN-HP-8IOL-12-30M



UR67-MP-HP-16DI-12-60M



UR67-MP-HP-8DIDO-12-60M



UR67-PB-12-8DI-8-30K



SAI-AU M8 CAN 16DI/8DO

Tip	Açıklama	Sipariş No	Fiyat/Birim	Ambalaj
u-remote IP 67				
IO-Link Modülleri				
UR67-PN-HP-8IOL-12-30M	4 Typ A ve 4 Typ B Port, 8 DI veya 8 DO programlanabilir, (M12)	2426250000	550,00 €	1
UR67-PN-HP-8IOL-12-60M	4 Typ A ve 4 Typ B Port, 8 DI veya 8 DO programlanabilir, (M12)	2426260000	543,00 €	1
Multiprotocol Modülleri (PROFINET/ EtherCAT / EthernetIP)				
Güç Kaynağı Bağlantısı : M12, L-coded (16 A)				
UR67-MP-HP-16DI-12-60M	16 DI, (M12)	2426270000	527,00 €	1
UR67-MP-HP-16DO-12-60M	16 DO, (M12)	2426280000	560,00 €	1
UR67-MP-HP-8DIDO-12-60M	8 DI, 8 DO, (M12)	2426290000	570,00 €	1
Güç Kaynağı Bağlantısı : 7/8", 5-pole				
UR67-MP-78-8DIDO-12-60M	8 DI, 8 DO, (M12)	2426320000	573,00 €	1
UR67-MP-78-16DI-12-60M	16 DI, (M12)	2426300000	530,00 €	1
UR67-MP-78-16DO-12-60M	16 DO, (M12)	2426310000	563,00 €	1
PROFIBUS-DP Modülleri				
Güç Kaynağı Bağlantısı : M12, 5-pole, A-coded				
UR67-PB-12-8DI-8-30K	8 DI, (M8)	2426360000	407,00 €	1
UR67-PB-12-8DIO-8-30K	8 programlanabilir universal port (M8)	2426330000	440,00 €	1
Güç Kaynağı Bağlantısı : 7/8", 5-pole				
UR67-PB-78-16DI-12-60K	16 DI, (M12)	2426370000	487,00 €	1
UR67-PB-78-16DIO-12-60K	16 programlanabilir universal port (M12)	2426340000	553,00 €	1
UR67-PB-78-16DI-12-60M	16 DI, (M12)	2426390000	523,00 €	1
UR67-PB-78-16DO-12-60M	16 DO, (M12)	2426400000	540,00 €	1
UR67-PB-78-8DIDO-12-60M	8 DI, 8 DO, (M12)	2426380000	560,00 €	1
CANopen Modülleri				
Güç Kaynağı Bağlantısı : M12, 5-pole, A-coded				
SAI-AU M8 CAN 16DI/8DO	16DI, 8 DO programlanabilir, (M8)	1906690000	579,00 €	1
SAI-AU M12 CAN 16DI/8DO	16DI, 8 DO programlanabilir, (M12)	1906660000	517,00 €	1
SAI-AU M8 CAN 16DI	16 DI, (M8)	1906680000	501,00 €	1
SAI-AU M12 CAN 16DI	16 DI, (M12)	1906650000	496,00 €	1
SAI-AU M12 CAN AI/AO/DI	4 AI, 2 AO, 4 DI, (M12)	1906670000	859,00 €	1
DeviceNet Modülleri				
Güç Kaynağı Bağlantısı : M12, 5-pole, A-coded				
SAI-AU M8 DN 16DI	16 DI, (M8)	1906730000	558,00 €	1
SAI-AU M12 DN 16DI	16 DI, (M12)	1906700000	780,00 €	1
SAI-AU M8 DN 16DI/8DO	16DI, 8 DO programlanabilir, (M8)	1906740000	571,00 €	1
SAI-AU M12 DN 16DI/8DO	16DI, 8 DO programlanabilir, (M12)	1906710000	822,00 €	1
SAI-AU M12 DN AI/AO/DI	4 AI, 2 AO, 4 DI, (M12)	1906720000	749,00 €	1
SAI-AU M12 DN GW 16DI	16 DI, Subbus sistemi için Gateway modülü	1938570000	571,00 €	1



UV20-B-IPC-1000.01



UV20-B-IPC-2001.03



UV20-B-IPC-3000.01



UV66-BAS-7-IPPC-1001.01



UV66-ADV-12-IPPC-1001.01

Tip	Açıklama	Sipariş No	Fiyat/Birim	Ambalaj
u-view Endüstriyel PC'ler				
Ultra Compact IPC 1000				
* UV20-B-IPC-1000.01	Intel® Atom® x5-E3930 Dual Core 1,30 GHz, up to 1,8 GHz boost, 2 GB DDR4 RAM, 60 GB SSD, İşletim sistemi yüklü değildir.	2676340000	1.785,00 €	1
* UV20-B-IPC-1011.01	Intel® Atom® x7-E3950 Quad Core 1,60 GHz, up to 2,00 GHz boost, 4 GB DDR RAM, 60 GB SSD	2665800000	2.205,00 €	1
* UV20-B-IPC-1011.02	Intel® Atom® x7-E3950 Quad Core 1,60 GHz, up to 2,00 GHz boost, 4 GB DDR RAM, 120 GB SSD	2676350000	2.268,00 €	1
* UV20-B-IPC-10XX - DIN RAIL MOUNTING KIT	Ultra Compact Seri Ray Montaj Aparatı	2676710000	25,20 €	1
* İşletim sistemi: Microsoft Windows 10 IoT Enterprise 2019 64bit				
Compact IPC 2000				
* UV20-B-IPC-2001.01	Intel Celeron J1900 Quad Core 2,0 GHz, up to 2,42 GHz boost, 4 GB DDR3 RAM, 60 GB SSD	2676370000	2.394,00 €	1
* UV20-B-IPC-2001.02	Intel Celeron J1900 Quad Core 2,0 GHz, up to 2,42 GHz boost, 4 GB DDR3 RAM, 60 GB SSD, İşletim sistemi yüklü değildir.	2665810000	2.058,00 €	1
* UV20-B-IPC-2001.03	Intel Celeron J1900 Quad Core 2,0 GHz, up to 2,42 GHz boost, 4 GB DDR3 RAM, 120 GB SSD	2676380000	2.541,00 €	1
* UV20-B-IPC-20XX - DIN RAIL MOUNTING KIT	Compact Seri Ray Montaj Aparatı	2676720000	49,35 €	1
* İşletim sistemi: Microsoft Windows 10 IoT Enterprise 2019 64bit				
Performant Serisi IPC 3000				
* UV20-B-IPC-3000.01	Intel® Celeron® 3955U 2,00 GHz, 4 GB DDR4 RAM, 60 GB SSD	2676390000	3.150,00 €	1
* UV20-B-IPC-3010.01	Intel® Core® i3-6100U 2,30 GHz, 4 GB DDR4 RAM, 60 GB SSD	2676400000	3.843,00 €	1
* UV20-B-IPC-3021.01	Intel® Core® i5-6300U 2,40 GHz, up to 3,00 GHz boost, 8 GB DDR4 RAM, 120 GB SSD	2676410000	4.788,00 €	1
* UV20-B-IPC-3031.01	Intel Core i7-6600U 2,6GHz, up to 3,4GHz boost, 8 GB DDR4 RAM, 120 GB SSD	2665820000	5.775,00 €	1
* UV20-B-IPC-3032.01	Intel Core i7-6600U 2,6GHz, up to 3,4GHz boost, 16 GB DDR4 RAM, 120 GB SSD İşletim sistemi yüklü değildir	2676420000	5.460,00 €	1
* İşletim sistemi: Microsoft Windows 10 IoT Enterprise 2019 64bit				
u-view Endüstriyel Panel PC'ler				
Compact Panel PC - IPPC 1000 Serisi				
* UV66-BAS-7-IPPC-1001.01	7 inch Resistive Dokunmatik Ekran, Intel Celeron J1900 Quad Core 2,0 GHz, up to 2,42 GHz boost, 4 GB DDR4 RAM, 60 GB SSD	2676430000	2.520,00 €	1
* UV66-ADV-7-IPPC-1001.01	7 inch Kapasitif Multi-touch Ekran, Intel Celeron J1900 Quad Core 2,0 GHz, up to 2,42 GHz boost, 4 GB DDR4 RAM, 60 GB SSD	2665830000	2.730,00 €	1
* UV66-BAS-10-IPPC-1001.01	10,1 inch Resistive Dokunmatik Ekran, Intel Celeron J1900 Quad Core 2,0 GHz, up to 2,42 GHz boost, 4 GB DDR4 RAM, 60 GB SSD	2676450000	3.045,00 €	1
* UV66-ADV-10-IPPC-1001.01	10,1 inch Kapasitif Multi-touch Ekran, Intel Celeron J1900 Quad Core 2,0 GHz, up to 2,42 GHz boost, 4 GB DDR4 RAM, 60 GB SSD	2676460000	3.360,00 €	1
* UV66-BAS-12-IPPC-1001.01	12,1 inch Resistive Dokunmatik Ekran, Intel Celeron J1900 Quad Core 2,0 GHz, up to 2,42 GHz boost, 4 GB DDR4 RAM, 60 GB SSD	2676470000	3.255,00 €	1
* UV66-ADV-12-IPPC-1001.01	12,1 inch Kapasitif Multi-touch Ekran, Intel Celeron J1900 Quad Core 2,0 GHz, up to 2,42 GHz boost, 4 GB DDR4 RAM, 60 GB SSD	2676480000	3.570,00 €	1
* UV66-BAS-15-IPPC-1001.01	15,6 inch Resistive Dokunmatik Ekran, Intel Celeron J1900 Quad Core 2,0 GHz, up to 2,42 GHz boost, 4 GB DDR4 RAM, 60 GB SSD	2676490000	3.500,00 €	1
* UV66-ADV-15-IPPC-1001.01	15,6 inch Kapasitif Multi-touch Ekran, Intel Celeron J1900 Quad Core 2,0 GHz, up to 2,42 GHz boost, 4 GB DDR4 RAM, 60 GB SSD	2676500000	3.780,00 €	1
* İşletim sistemi: Microsoft Windows 10 IoT Enterprise 2019 64bit				



UV66-ADV-15-IPPC-3022.01



UV66-ADV-12-IPM-10



UV66-ADV-21-IPM-10

Tip	Açıklama	Sipariş No	Fiyat/Birim	Ambalaj
Performant Panel PC - IPPC 3000 Serisi				
* UV66-ADV-12-IPPC-3001.01	12,1 inch Kapasitif Multi-touch Ekran, Intel Celeron 3765U Dual Core 1,9 GHz, 4 GB DDR4 RAM, 60 GB SSD	2676510000	4.032,00 €	1
* UV66-ADV-12-IPPC-3022.01	12,1 inch Kapasitif Multi-touch Ekran, Intel Core i5-5350U 1,8GHz, up to 2,9GHz boost, 8 GB DDR4 RAM, 120 GB SSD	2676520000	5.817,00 €	1
* UV66-ADV-15-IPPC-3001.01	15,6 inch Kapasitif Multi-touch Ekran, Intel Celeron 3765U Dual Core 1,9 GHz, 4 GB DDR4 RAM, 60 GB SSD	2676530000	4.305,00 €	1
* UV66-ADV-15-IPPC-3022.01	15,6 inch Kapasitif Multi-touch Ekran, Intel Core i5-5350U 1,8GHz, up to 2,9GHz boost, 8 GB DDR4 RAM, 120 GB SSD	2676540000	6.069,00 €	1
* UV66-ADV-18-IPPC-3001.01	18,5 inch Kapasitif Multi-touch Ekran, Intel Celeron 3765U Dual Core 1,9 GHz, 4 GB DDR4 RAM, 60 GB SSD	2676550000	5.124,00 €	1
* UV66-ADV-18-IPPC-3022.01	18,5 inch Kapasitif Multi-touch Ekran, Intel Core i5-5350U 1,8GHz, up to 2,9GHz boost, 8 GB DDR4 RAM, 120 GB SSD	2676560000	6.930,00 €	1
* UV66-ADV-21-IPPC-3001.01	21,5 inch Kapasitif Multi-touch Ekran, Intel Celeron 3765U Dual Core 1,9 GHz, 4 GB DDR4 RAM, 60 GB SSD	2676570000	5.439,00 €	1
* UV66-ADV-21-IPPC-3022.01	21,5 inch Kapasitif Multi-touch Ekran, Intel Core i5-5350U 1,8GHz, up to 2,9GHz boost, 8 GB DDR4 RAM, 120 GB SSD	2676580000	7.350,00 €	1

* İşletim sistemi: Microsoft Windows 10 IoT Enterprise 2019 64bit

u-view Endüstriyel Mönitörler**Endüstriyel Mönitörler - IPM 10 Serisi**

* UV66-ADV-10-IPM-10	10,1 inch Kapasitif Multi-touch Ekran	2676660000	2.121,00 €	1
* UV66-ADV-12-IPM-10	12,1 inch Kapasitif Multi-touch Ekran	2676670000	2.247,00 €	1
* UV66-ADV-15-IPM-10	15,6 inch Kapasitif Multi-touch Ekran	2676680000	2.415,00 €	1
* UV66-ADV-18-IPM-10	18,5 inch Kapasitif Multi-touch Ekran	2676690000	3.150,00 €	1
* UV66-ADV-21-IPM-10	21,5 inch Kapasitif Multi-touch Ekran	2676700000	3.654,00 €	1

u-view HMI Paneller**HMI Paneller**

* UV66-ECO-4-RES-W	4,3 inch Resistive HMI Panel	2555660000	515,00 €	1
* UV66-ECO-7-RES-W	7 inch Resistive HMI Panel	2555780000	680,00 €	1
* UV66-ECO-10-RES-W	10,1 inch Resistive HMI Panel	2555790000	974,00 €	1

u-remote Yedek Parçaları

“İhtiyaç durumunda u-remote modüllerine ait olan yedek parçaları taban, elektronik modül ve konnektör girişleri şeklinde 3 farklı bileşen olarak ayrı ayrı sipariş edebilirsiniz.”



Ana Ürünler		Konnektör Parçaları-Ambalaj Adeti 5		Elektronik Kart Kısmı-Ambalaj Adeti 1		Taban Kısmı - Ambalaj adeti 5	
UR20-FBC-PB-DP	1334870000	UR20-PK-1334870000-SP	1361520000				
UR20-FBC-PN-HRT	1334880000	UR20-PK-1334880000-SP	1484120000				
UR20-FBC-EC	1334910000	UR20-PK-1334910000-SP	1484440000				
UR20-FBC-MOD	1334930000	UR20-PK-1334930000-SP	1484130000				
UR20-4DI-P	1315170000	UR20-PK-1315170000-SP	1346440000	UR20-EM-1315170000-SP	1346640000	UR20-BM-SP	1350930000
UR20-8DI-P-2W	1315180000	UR20-PK-1315180000-SP	1346430000	UR20-EM-1315080000-SP	1346650000	UR20-BM-SP	1350930000
UR20-8DI-P-3W	1394400000	UR20-PK-1394400000-SP	1411430000	UR20-EM-1394400000-SP	1434220000	UR20-BM-SP	1350930000
UR20-16DI-P	1315200000	UR20-PK-1315200000-SP	1346400000	UR20-EM-1315200000-SP	1346680000	UR20-BM-SP	1350930000
UR20-16DI-P-PLC-INT	1315210000	UR20-PK-1315210000-SP	1346590000	UR20-EM-1315210000-SP	1346690000	UR20-BM-SP	1350930000
UR20-2DI-P-TS	1460140000	UR20-PK-1460140000-SP	1484110000	UR20-EM-1460140000-SP	1463690000	UR20-BM-SP	1350930000
UR20-4DI-P-TS	1460150000	UR20-PK-1460150000-SP	1484430000	UR20-EM-1460150000-SP	1463680000	UR20-BM-SP	1350930000
UR20-4DO-P	1315220000	UR20-PK-1315220000-SP	1483960000	UR20-EM-1315220000-SP	1346700000	UR20-BM-SP	1350930000
UR20-4DO-P-2A	1315230000	UR20-PK-1315230000-SP	1483970000	UR20-EM-1315230000-SP	1346710000	UR20-BM-SP	1350930000
UR20-4DO-PN-2A	1394420000	UR20-PK-1394420000-SP	1483980000	UR20-EM-1394420000-SP	1480950000	UR20-BM-SP	1350930000
UR20-8DO-P	1315240000	UR20-PK-1315240000-SP	1346410000	UR20-EM-1315240000-SP	1346720000	UR20-BM-SP	1350930000
UR20-16DO-P	1315250000	UR20-PK-1315250000-SP	1483990000	UR20-EM-1315250000-SP	1346730000	UR20-BM-SP	1350930000
UR20-16DO-P-PLC-INT	1315270000	UR20-PK-1315270000-SP	1483940000	UR20-EM-1315270000-SP	1346740000	UR20-BM-SP	1350930000
UR20-4RO-SSR-255	1315540000	UR20-PK-1315540000-SP	1484000000	UR20-EM-1315540000-SP	1347120000	UR20-BM-SP	1350930000
UR20-4RO-CO-255	1315550000	UR20-PK-1315550000-SP	1346500000	UR20-EM-1315550000-SP	1347130000	UR20-BM-SP	1350930000
UR20-1CNT-100-1DO	1315570000	UR20-PK-1315570000-SP	1346520000	UR20-EM-1315570000-SP	1347140000	UR20-BM-SP	1350930000
UR20-2CNT-100	1315590000	UR20-PK-1315590000-SP	1346540000	UR20-EM-1315590000-SP	1347150000	UR20-BM-SP	1350930000
UR20-2PWM-PN-0.5A	1315600000	UR20-PK-1315600000-SP	1484010000	UR20-EM-1315600000-SP	1347180000	UR20-BM-SP	1350930000
UR20-2PWM-PN-2A	1315610000	UR20-PK-1315610000-SP	1346550000	UR20-EM-1315610000-SP	1347190000	UR20-BM-SP	1350930000
UR20-4AI-UI-16	1315620000	UR20-PK-1315620000-SP	1484020000	UR20-EM-1315620000-SP	1347200000	UR20-BM-SP	1350930000
UR20-4AI-UI-12	1394390000	UR20-PK-1394390000-SP	1484030000	UR20-EM-1394390000-SP	1434230000	UR20-BM-SP	1350930000
UR20-8AI-PLC-INT	1315670000	UR20-PK-1315670000-SP	1483950000	UR20-EM-1315670000-SP	1347250000	UR20-BM-SP	1350930000
UR20-4AI-TC-DIAG	1315710000	UR20-PK-1315710000-SP	1484050000	UR20-EM-1315710000-SP	1435740000	UR20-BM-SP	1350930000
UR20-4AI-RTD-DIAG	1315700000	UR20-PK-1315700000-SP	1484040000	UR20-EM-1315700000-SP	1347290000	UR20-BM-SP	1350930000
UR20-4AO-UI-16	1315680000	UR20-PK-1315680000-SP	1484070000	UR20-EM-1315680000-SP	1347270000	UR20-BM-SP	1350930000
UR20-PF-I	1334710000	UR20-PK-1334710000-SP	1346460000	UR20-EM-1334710000-SP	1347370000	UR20-BM-PF-I-SP	1350940000
UR20-PF-O	1334740000	UR20-PK-1334740000-SP	1346480000	UR20-EM-1334740000-SP	1347420000	UR20-BM-PF-O-SP	1350950000
UR20-PF-O-1DI-SIL	1335030000	UR20-PK-1335030000-SP	1346560000	UR20-EM-1335030000-SP	1347520000	UR20-BM-SIL-SP	1350970000
UR20-PF-O-2DI-SIL	1335050000	UR20-PK-1335050000-SP	1346570000	UR20-EM-1335050000-SP	1347540000	UR20-BM-SIL-SP	1350970000
UR20-PF-O-2DI-DELAY-SIL	1335040000	UR20-PK-1335040000-SP	1484100000	UR20-EM-1335040000-SP	1347530000	UR20-BM-SIL-SP	1350970000
UR20-16AUX-I	1334770000	UR20-PK-1334770000-SP	1346450000	UR20-EM-1334770000-SP	1347450000	UR20-BM-SP	1350930000
UR20-16AUX-O	1334780000	UR20-PK-1334780000-SP	1484080000	UR20-EM-1334780000-SP	1347470000	UR20-BM-SP	1350930000
UR20-16AUX-FE	1334790000	UR20-PK-1334790000-SP	1346490000	UR20-EM-1334790000-SP	1347480000	UR20-BM-SP	1350930000
UR20-16AUX-GND-I	1334800000	UR20-PK-1334800000-SP	1346470000	UR20-EM-1334800000-SP	1347490000	UR20-BM-SP	1350930000
UR20-16AUX-GND-O	1334810000	UR20-PK-1334810000-SP	1484090000	UR20-EM-1334810000-SP	1347500000	UR20-BM-SP	1350930000
UR20-ES	1315770000	UR20-PK-1315770000-SP	1346510000	UR20-EM-1315770000-SP	1347370000	UR20-BM-SP	1350930000

SAI - Sensör Aktuatör Arayüzleri

SAI blokları sensör aktuatör sinyallerini sahada toplayarak PLC'ye aktarmaktan sorumludur. Bu kablolama ve servis masraflarını ve sürelerini azaltmak anlamına gelmektedir. Önceden hazırlanmış iletkenler ve M8/M12 konnektörlerle çalışıldığı için bağlantı hataları sıfıra indirilir. Weidmüller SAI bloklarının özellikleri şöyledir:

- Güvenilirlik
- Uzun vade de düşük maliyet
- Uzun ömürlülük
- Kısa arıza kaynaklı duruş süreleri

SAI Pasif

Bu modüller 4, 6 ve 8 kanallı olarak, M8,M12 konnektörlü ve 3, 4 ve 5 kutuplu olacak şekilde tercih edilebilirler. Bloklar makina üzerine direkt olarak monte edilirler. İnce ve sağlamdırlar. IP 68 koruma sınıfında üretilirler.

- SAI-F, Dağıtıcısı SAI-4/6/8-F Entegre edilmiş kablolu versiyon.
- SAI-M, Dağıtıcısı SAI-4/6/8-M Kablosuz versiyon.

SAI Aksesuarları

- Soketler ve fişler
- Sensör kabloları
- Markalama sistemleri
- El aletleri ve daha fazlası

Fieldbus Elemanları

Özellikle patlayıcı ortamlarda kullanılan FBCon Fieldbus dağıtıcılarını kapsar. Endüstriyel uygulamalar için gerilim korumalı ve akım sınırlayıcı versiyonları vardır.



SAI - Sensör Aktuatör Arayüzler



SAI-4-F 4P PUR 3M



SAI-6-F 4P PUR 3M



SAI-8-F 4P PUR 3M



SAI-4-M 4P M12



SAI-6-M 4P M12

Tip	Kablo Uzunluğu	Konnektör Kutup Sayısı	Sipariş No	Fiyat/Birim	Ambalaj
-----	----------------	------------------------	------------	-------------	---------

SAI Pasif Modüller ve Aksesuarları

SAI / Sensör-Aktuatör Arayüzleri - M12 - IP68 Hazır Kablolu

4 - Kanal

SAI-4-F 4P PUR 3M	3 Metre	4-kutup	9456180000	98,65 €	1
SAI-4-F 4P PUR 5M	5 Metre	4-kutup	9456190000	80,80 €	1
SAI-4-F 4P PUR 10M	10 Metre	4-kutup	9456200000	87,75 €	1
SAI-4-F 4P PUR 15M	15 Metre	4-kutup	9456210000	141,00 €	1
SAI-4-F 4P PUR 20M	20 Metre	4-kutup	9456230000	187,00 €	1
SAI-4-F 5P PUR 3M	3 Metre	5-kutup	9456320000	108,00 €	1
SAI-4-F 5P PUR 5M	5 Metre	5-kutup	9456330000	103,00 €	1
SAI-4-F 5P PUR 10M	10 Metre	5-kutup	9456340000	140,00 €	1
SAI-4-F 5P PUR 15M	15 Metre	5-kutup	9456350000	165,00 €	1
SAI-4-F 5P PUR 20M	20 Metre	5-kutup	9456370000	235,00 €	1

6 - Kanal

SAI-6-F 4P PUR 3M	3 Metre	4-kutup	9456460000	144,00 €	1
SAI-6-F 4P PUR 5M	5 Metre	4-kutup	9456470000	117,00 €	1
SAI-6-F 4P PUR 10M	10 Metre	4-kutup	9456480000	124,00 €	1
SAI-6-F 4P PUR 15M	15 Metre	4-kutup	9456490000	161,00 €	1
SAI-6-F 4P PUR 20M	20 Metre	4-kutup	9456510000	199,00 €	1
SAI-6-F 5P PUR 3M	3 Metre	5-kutup	9456600000	146,00 €	1
SAI-6-F 5P PUR 5M	5 Metre	5-kutup	9456610000	144,00 €	1
SAI-6-F 5P PUR 10M	10 Metre	5-kutup	9456620000	154,00 €	1
SAI-6-F 5P PUR 15M	15 Metre	5-kutup	9456630000	187,00 €	1
SAI-6-F 5P PUR 20M	20 Metre	5-kutup	9456650000	238,00 €	1

8 - Kanal

SAI-8-F 4P PUR 3M	3 Metre	4-kutup	9456740000	149,00 €	1
SAI-8-F 4P PUR 5M	5 Metre	4-kutup	9456750000	120,00 €	1
SAI-8-F 4P PUR 10M	10 Metre	4-kutup	9456760000	121,00 €	1
SAI-8-F 4P PUR 15M	15 Metre	4-kutup	9456770000	177,00 €	1
SAI-8-F 4P PUR 20M	20 Metre	4-kutup	9456790000	238,00 €	1
SAI-8-F 5P PUR 3M	3 Metre	5-kutup	9456880000	157,00 €	1
SAI-8-F 5P PUR 5M	5 Metre	5-kutup	9456890000	140,00 €	1
SAI-8-F 5P PUR 10M	10 Metre	5-kutup	9456900000	190,00 €	1
SAI-8-F 5P PUR 15M	15 Metre	5-kutup	9456910000	258,00 €	1
SAI-8-F 5P PUR 20M	20 Metre	5-kutup	9456930000	258,00 €	1

Tip	Açıklama	Konnektör Kutup Sayısı	Sipariş No	Fiyat/Birim	Ambalaj
-----	----------	------------------------	------------	-------------	---------

SAI Pasif Modüller ve Aksesuarları

SAI / Sensör-Aktuatör Arayüzleri - M12 - IP67

4 - Kanal

SAI-4-M 4P M12	Komple Modül	4-kutup	1705920000	77,55 €	1
SAI-4-M 4P M12 UT	Ana Modül	4-kutup	1705921000	56,95 €	2
SAI-4-M 5P M12	Komple Modül	5-kutup	1701230000	80,00 €	1
SAI-4-M 5P M12 UT	Ana Modül	5-kutup	1701231000	67,70 €	2

6 - Kanal

SAI-6-M 4P M12	Komple Modül	4-kutup	1705930000	92,90 €	1
SAI-6-M 4P M12 UT	Ana Modül	4-kutup	1705931000	72,25 €	2
SAI-6-M 5P M12	Komple Modül	5-kutup	1701240000	110,00 €	1
SAI-6-M 5P M12 UT	Ana Modül	5-kutup	1701241000	87,25 €	2



SAI-8-M 4P M12



SAI-4-F 3P M8 PUR 5M



SAI-8-F 3P M8 PUR 5M



SAI-4-F 3P M8 L 5M



SAI-8-F 3P M8 L 5M

Tip	Açıklama	Konnektör Kutup Sayısı	Sipariş No	Fiyat/Birim	Ambalaj
8 - Kanal					
SAI-8-M 4P M12	Komple Modül	4-kutup	1705940000	106,00 €	1
SAI-8-M 4P M12 UT	Ana Modül	4-kutup	1705941000	110,00 €	2
SAI-8-M 5P M12	Komple Modül	5-kutup	1701250000	110,00 €	1
SAI-8-M 5P M12 OL UT	Ana Modül	5-kutup	1740191000	116,00 €	2
4/6/8 - Kanal Bağlantı Modülü					
SAI-4/6/8-MH BLZF3.5	Yaylı Bağlantı Modülü		1752080000	36,85 €	1
SAI-4/6/8-MH BL3.5	Vidalı Bağlantı Modülü		1724750000	22,05 €	1

Tip	Kablo Uzunluğu	Konnektör Kutup Sayısı	Sipariş No	Fiyat/Birim	Ambalaj
-----	----------------	------------------------	------------	-------------	---------

SAI Pasif Modüller ve Aksesuarları**SAI / Sensör-Aktuatör Arayüzleri - M8 - IP68 Hazır Kablolu**

Tip	Kablo Uzunluğu	Konnektör Kutup Sayısı	Sipariş No	Fiyat/Birim	Ambalaj
-----	----------------	------------------------	------------	-------------	---------

4 - Kanal

SAI-4-F 3P M8 PUR 5M	5 Metre	3-kutup	1784640000	128,00 €	1
SAI-4-F 3P M8 PUR 10M	10 Metre	3-kutup	1784630000	229,00 €	1
SAI-4-F 4P M8 PUR 5M	5 Metre	4-kutup	1784600000	150,00 €	1
SAI-4-F 4P M8 PUR 10M	10 Metre	4-kutup	1784590000	214,00 €	1

8 - Kanal

SAI-8-F 3P M8 PUR 5M	5 Metre	3-kutup	1784620000	173,00 €	1
SAI-8-F 3P M8 PUR 10M	10 Metre	3-kutup	1784610000	209,00 €	1
SAI-8-F 4P M8 PUR 5M	5 Metre	4-kutup	1784580000	203,00 €	1
SAI-8-F 4P M8 PUR 10M	10 Metre	4-kutup	1784570000	250,00 €	1

SAI / Sensör-Aktuatör Arayüzleri - M8 - IP68**4 - Kanal**

SAI-4-M 3P M8	Komple Modül	3-kutup	1784680000	146,00 €	1
SAI-4-M 4P M8	Komple Modül	4-kutup	1784700000	153,00 €	1

8 - Kanal

SAI-8-M 3P M8	Komple Modül	3-kutup	1784670000	162,00 €	1
SAI-8-M 4P M8	Komple Modül	4-kutup	1784690000	160,00 €	1

SAI / Sensör-Aktuatör Arayüzleri - M8 - IP68 Hazır Kablolu**4 - Kanal**

SAI-4-F 3P M8 L 5M	5 Metre	3-kutup	1828720000	88,50 €	1
SAI-4-F 3P M8 L 10M	10 Metre	3-kutup	1828710000	119,00 €	1
SAI-4-F 4P M8 L 5M	5 Metre	4-kutup	1849680000	111,00 €	1
SAI-4-F 4P M8 L 10M	10 Metre	4-kutup	1849690000	180,00 €	1

6 - Kanal

SAI-6-F 3P M8 L 5M	5 Metre	3-kutup	1828700000	113,00 €	1
SAI-6-F 3P M8 L 10M	10 Metre	3-kutup	1828690000	146,00 €	1
SAI-6-F 4P M8 L 5M	5 Metre	4-kutup	1849700000	151,00 €	1
SAI-6-F 4P M8 L 10M	10 Metre	4-kutup	1849670000	192,00 €	1

8 - Kanal

SAI-8-F 3P M8 L 5M	5 Metre	3-kutup	1828680000	130,00 €	1
SAI-8-F 3P M8 L 10M	10 Metre	3-kutup	1828670000	150,00 €	1
SAI-8-F 4P M8 L 5M	5 Metre	4-kutup	1828620000	171,00 €	1
SAI-8-F 4P M8 L 10M	10 Metre	4-kutup	1828610000	207,00 €	1

10 - Kanal

SAI-10-F 3P M8 L 5M	5 Metre	3-kutup	1828660000	208,00 €	1
SAI-10-F 3P M8 L 10M	10 Metre	3-kutup	1828650000	255,00 €	1

12 - Kanal

SAI-12-F 3P M8 L 5M	5 Metre	3-kutup	1828640000	244,00 €	1
SAI-12-F 3P M8 L 10M	10 Metre	3-kutup	1828630000	298,00 €	1

SAI - Sensör Aktuatör Arayüzler



SAIS-3/9



SAISW-3/9



SAIS-3-IDC-M12B-COD



SAISW-M-5/8 M12



SAISM-4/8S-M12-4P D-COD



SAIS-M8-3P



SAISM-M8-3P-(IF)

Tip	Açıklama	Sipariş No	Fiyat/Birim	Ambalaj
SAI Pasif Modüller ve Aksesuarları				
M12 Sensör Aktuatör Konektörleri (A-COD/ IP67)				
SAIS-3/9	M12 Düz,Erkek, 3 Kutup PG 9	1021480000	11,00 €	1
SAIS-4/9	M12 Düz,Erkek, 4 Kutup PG 9	1807340000	9,50 €	1
SAISW-3/9	M12 Açılı ,Erkek ,3 Kutup PG9	1021290000	11,00 €	1
SAISW-4/9	M12 Açılı ,Erkek ,4 Kutup PG9	1807360000	11,75 €	1
SAIS-5/9	M12 Düz,Erkek, 5 Kutup PG 9	1807350000	9,90 €	1
SAISW-5/9	M12 Açılı ,Erkek ,5 Kutup PG9	1807370000	12,25 €	1
SAIS-5/7-ZF	M12 Düz,Erkek 5 Kutup Yaylı Bağlantı PG7	1906390000	18,00 €	1
SAIS-8/9	M12 Düz,Erkek, 8 Kutup PG 9	1836970000	28,00 €	1
SAIB-3/9	M12 Düz,Dişi,3 Kutup PG9	1021510000	11,20 €	1
SAIB-4/9	M12 Düz,Dişi,4 Kutup PG9	1807230000	9,90 €	1
SAIBW-3/9	M12 Açılı,Dişi,3 Kutup PG9	1021320000	11,20 €	1
SAIBW-4/9	M12 Açılı,Dişi,4 Kutup PG9	1807240000	12,00 €	1
SAIB-5/9	M12 Düz,Dişi,5 Kutup PG9	1807250000	13,00 €	1
SAIBW-5/9	M12 Açılı,Dişi,5 Kutup PG9	1807330000	14,00 €	1
SAIB-5/7-ZF	M12 Düz, Dişi 5 Kutup Yaylı Bağlantı PG7	1924970000	17,60 €	1
Not: PG7 Kablo girişli ürünler için Lütfen irtibat kurunuz				
M12 Sensör Aktuatör Konektörleri (Profibus için / B-COD) Metal				
SAISM 5/8S M12 5P B-COD	M12 Düz,Erkek,5 Kutuplu PG 9 -Metal EMC(IP67)	1784790000	26,00 €	1
SAIBM 5/8S M12 5P B-COD	M12 Düz,Dişi,5 Kutuplu PG 9 -Metal EMC(IP67)	1784780000	26,00 €	1
SAIS-3-IDC-M12B-COD	M12 Düz, Erkek,3 Kutuplu PG 9 -Metal EMC(IP67)	1864730000	34,95 €	1
SAIB-3-IDC-M12B-COD	M12 Düz,Dişi,3 Kutuplu PG 9 -Metal EMC(IP67)	1864740000	36,00 €	1
SAISW-M-5/8 M12 B-COD	M12 Açılı ,Erkek ,5 Kutup PG9	1944570000	34,95 €	1
SAIBW-M-5/8 M12 B-COD	M12 Açılı ,Dişi,5 Kutup PG9	1944580000	35,20 €	1
SAIS 5/9-VA-B-COD	M12 Düz, Erkek,5 Kutuplu PG9 -Paslanmaz Çelik(IP 69K)	1920720000	62,25 €	1
SAIB 5/9-VA-B-COD	M12 Düz,Dişi,5 Kutuplu PG9 - Paslanmaz Çelik(IP69K)	1920730000	63,75 €	1
M12 Sensör Aktuatör Konektörleri (A-COD) Metal				
SAIS-M-5/8S M12 5P A-COD	M12 Düz,Erkek 5 Kutuplu (IP67) PG9	1784740000	24,00 €	1
SAIB-M-5/8S M12 5P A-COD	M12 Düz,Dişi 5 Kutuplu (IP67) PG9	1784750000	24,00 €	1
SAISW-M-5/8 M12	M12 Açılı Erkek 5 Kutuplu (IP67) PG9	1803940000	25,45 €	1
SAIBW-M-5/8 M12	M12 Açılı Dişi 5 Kutuplu (IP67) PG9	1803920000	26,15 €	1
SAIS 5/9-VA	M12 Düz,Erkek 5 Kutuplu Yaylı Bağlantı (IP69K)	1920700000	62,25 €	1
SAIB 5/9-VA	M12 Düz,Dişi 5 Kutuplu Yaylı Bağlantı (IP69K)	1920710000	59,20 €	1
M12 Sensör Aktuatör Konektörleri Endüstriyel Ethernet(D-COD) Metal				
SAISM-4/8S-M12-4P D-COD	M12 Düz,Erkek 4 Kutuplu (IP67)	1892120000	22,00 €	1
SAIBM-4/8S-M12-4P D-COD	M12 Düz,Dişi 4 Kutuplu (IP67)	1892130000	19,00 €	1
SAISM-4/8S-M12 4P D-ZF	M12 Düz,Erkek 4 Kutuplu (IP67)	1892120001	32,20 €	1
SAIBM-4/8S-M12 4P D-ZF	M12 Düz,Dişi 4 Kutuplu,Yaylı Bağlantı (IP67)	1892130001	33,45 €	1
SAISW-4/8S-M12 4P D-ZF	M12 Açılı,Erkek 4 Kutuplu,Yaylı Bağlantı (IP67)	1803930001	34,15 €	1
SAIBW-4/8S-M12 4P D-ZF	M12 Açılı,Erkek 4 Kutuplu,Yaylı Bağlantı (IP67)	1139330000	34,40 €	1
Sensör Aktuatör Konektörleri (M8 PLASTİK)				
SAIS-M8-3P	M8 Düz,Erkek, 3 Kutup	1803860000	14,00 €	1
SAIS-M8-4P	M8 Düz,Erkek, 4 Kutup	1803850000	14,35 €	1
SAIB-M8-3P	M8 Düz,Dişi ,3 Kutup	1803870000	12,00 €	1
SAIB-M8-4P	M8 Düz,Dişi ,4 Kutup	1803880000	14,35 €	1
Sensör Aktuatör Konektörleri (M8 METAL)				
SAISM-M8-3P-(IF)	M8 Düz,Erkek, 3 Kutup	1010060000	30,00 €	1
SAISM-M8-4P-(IF)	M8 Düz,Erkek, 4 Kutup	1010070000	26,00 €	1
SAIBM-M8-3P-(IF)	M8 Düz ,Dişi ,3 Kutup	1010080000	24,65 €	1
SAIBM-M8-4P-(IF)	M8 Düz ,Dişi ,4 Kutup	1010090000	26,00 €	1



SAIS-4-IDC M12 small



SAI-Y-5S B2-4 2M12



Screwty Set



PB-DP SUB-D M12 TERM

Tip	Açıklama	Sipariş No	Fiyat/Birim	Ambalaj	
Sensör Aktuatör Konektörleri (IDC)					
SAIS-4-IDC M12 small	M12 Düz,Erkek, 4 Kutup	1781550001	11,25 €	1	
SAIB-4-IDC-M12 small	M12 Düz,Dişi, 4 Kutup	1781540001	12,40 €	1	
SAISW-4-IDC M12	M12 Açılı,Erkek, 4 Kutup	1812870000	22,95 €	1	
SAIBW-4-IDC M12	M12 Açılı,Dişi, 4 Kutup	1812890000	23,20 €	1	
SAIS-3-IDC M8 small	M8 Düz,Erkek, 3 Kutup	1784040001	11,40 €	1	
SAIS-4-IDC M8 small	M8 Düz,Erkek, 4 Kutup	1784060001	14,40 €	1	
SAIB-3-IDC-M8 small	M8 Düz,Dişi, 3 Kutup	1784030001	12,95 €	1	
SAIB-4-IDC-M8 small	M8 Düz,Dişi, 4 Kutup	1784050001	14,00 €	1	
Dağıtıcı T Konektörler					
SAI-Y-5S B2-4 2M12	Distribution, Pin 2 + 4 Bridged	1783410000	23,05 €	1	
SAI-Y-5S PARA 2M12	Parallel Distribution	1783430000	23,05 €	1	
SAI-Y-5S- M12/M12	Individual Distribution	1826880000	30,00 €	1	
SAI-Y-4-4/2-4 M12/8	Individual Distribution	1783420000	23,05 €	1	
Yardımcı El Aleti					
Screwty Set	Konektör Sıkma El Aleti	1910000000	2.390,00 TL	1	
Tip	Açıklama	Ölçü	Sipariş No	Fiyat/Birim	Ambalaj
SAI Pasif Modüller ve Aksesuarları					
Aksesuar					
SAI-SK-M12	SAI M12 Kapak	M12	9456050000	0,55 €	30
SAI-SK M8	SAI M8 Kapak	M8	1802760000	2,00 €	50
SAI-SK M5	SAI M5 Kapak	M5	1855310000	1,85 €	50
SAI-SK-M12-UNI	SAI M12 Kapak	M12 Universal	2330260000	1,85 €	20
ESG 9/20 MC NE WS	Beyaz		1609940000	2,27 TL	200
Tip	Ölçü	Açıklama	Sipariş No	Fiyat/Birim	Ambalaj
SAI Pasif Modüller ve Aksesuarları					
Hazır Bus Kablolar					
SAIL-M8GM8G-4S-0.15U-SB	15 cm	Düz M8 erkek-dişi	1981900015	30,80 €	1
SAIL-M8GM8G-4S-0.3U-SB	30 cm	Düz M8 erkek-dişi	1981900030	32,55 €	1
SAIL-M8GM8G-4S-1.0U-SB	1 m	Düz M8 erkek-dişi	1981900100	32,80 €	1
SAIL-M8GM8G-4S-1.5U-SB	1,5 m	Düz M8 erkek-dişi	1981900150	37,35 €	1
SAIL-M8GM8G-4S-3.0U-SB	3 m	Düz M8 erkek-dişi	1981900300	43,05 €	1
SAIL-M8GM8G-4S-5.0U-SB	5 m	Düz M8 erkek-dişi	1981900500	52,55 €	1
SAIL-M8GM8G-4S-10U-SB	10 m	Düz M8 erkek-dişi	1981901000	72,95 €	1
Tip	Koruma Sınıfı	Sipariş No	Fiyat/Birim	Ambalaj	
SAI Pasif Modüller ve Aksesuarları					
Profibus DP Sub D Konektörler					
PB-DP SUB-D M12 TERM	IP30	1140650000	84,15 €	1	
PB-DP SUB-D M12 TERM PS	IP30	1140640000	90,10 €	1	
PB-DP SUB-D ZF35TERM	IP30	1173220000	72,90 €	1	
PB-DP SUB-D ZF35TERM PS	IP30	1173240000	80,00 €	1	
PB-DP SUB-D ZF TERM	IP30	1161870000	72,90 €	1	
PB-DP SUB-D ZF TERM PS	IP30	1161880000	79,50 €	1	



Endüstriyel Ethernet

Endüstriyel ethernet network teknolojisinde günden güne öne çıkan bir standart haline gelmektedir. Çünkü planlama ve üretim aşamasında bu uygulamalardan alınan verim daha fazladır. Üreticiler network ağlarıyla tesisleri birbirine entegre edebilmektedir.

Birçok uygulama haberleşme standartları, yazılımlar, ve protokoller ile belirleniyorsa da, bir network'ün fiziksel yapısının tamamen güvenilir bir şekilde çalışması gerekir. Çünkü endüstride hataların %80'inden fazlası bağlantı hatalarıdır. Örneğin; kablo kırılması vb.

Weidmüller, size uzun ömürlü, bakım gerektirmeyen elektrik bağlantılarını geleneksel ürünlerin yanında yenilikçi ürünlerini de önermektedir. Bu ürünler kontrolörlerden saha bağlantılarına kadar bir çok çeşiti kapsar.

STEADYTEC Teknolojili IE-LINE

Modüler yapısı sayesinde maksimum esneklik sağlar. IP 67 koruma mümkündür.

Endüstriyel alandaki avantajları şunlardır:

- Hızlı
- Güvenli
- Çözüm Odaklı
- Pratik





IE-SW-BL05-5TX



IE-SW-BL08T-7TX-1SC



IE-SW-VL16T-16TX



IE-SW-VL08T-8GT



IE-SW-BL06T-2TX-4POE



IE-SW-BL05-1GT-4GTPOE

Tip	Açıklama	Sipariş No	Fiyat/Birim	Ambalaj
Unmanaged - Yönetilemeyen Ethernet Switchler				
IE-SW-BL05-5TX	5 x RJ45	1240840000	165,00 €	1
IE-SW-BL05T-5TX	5 x RJ45 (-40 ... +75 °C)	1240850000	186,00 €	1
IE-SW-BL05-4TX-1SC	4 x RJ45, 1 x SC Multi-mode	1240890000	280,00 €	1
IE-SW-BL05T-4TX-1SC	4 x RJ45, 1 x SC Multi-mode (-40 ...+75 °C)	1286550000	317,00 €	1
IE-SW-BL05-4TX-1ST	4 x RJ45, 1 x ST Multi-mode	1240880000	320,00 €	1
IE-SW-BL05T-4TX-1ST	4 x RJ45, 1 x ST Multi-mode (-40 ...+75 °C)	1286540000	317,00 €	1
IE-SW-BL05-4TX-1SCS	4 x RJ45, 1 x SC Single-mode	1240870000	459,00 €	1
IE-SW-BL05T-4TX-1SCS	4 x RJ45, 1 x SC Single-mode (-40 ...+75 °C)	1286530000	529,00 €	1
IE-SW-BL08-8TX	8 x RJ45	1240900000	210,00 €	1
IE-SW-BL08T-8TX	8x RJ45, (-40 ...+75 °C)	1286560000	290,00 €	1
IE-SW-BL08-7TX-1ST	7x RJ45, 1 x ST Multi-mode	1412090000	324,00 €	1
IE-SW-BL08-7TX-1SC	7x RJ45, 1 x SC Multi-mode	1412070000	380,00 €	1
IE-SW-BL08T-7TX-1SC	7x RJ45, 1 x SC Multi-mode (-40 ...+75 °C)	1412080000	376,00 €	1
IE-SW-BL08T-7TX-1ST	7x RJ45, 1 x ST Multi-mode (-40 ...+75 °C)	1412100000	376,00 €	1
IE-SW-BL08-7TX-1SCS	7x RJ45, 1 x SC Single-mode	1240950000	515,00 €	1
IE-SW-BL08T-7TX-1SCS	7x RJ45, 1 x SC Single-mode (-40 ...+75 °C)	1286580000	602,00 €	1
IE-SW-BL08-6TX-2ST	6x RJ45, 2 x ST Multi-mode	1240930000	479,00 €	1
IE-SW-BL08-6TX-2SC	6 x RJ45, 2 x SC Multi-mode	1240910000	550,00 €	1
IE-SW-BL08T-6TX-2SC	6 x RJ45, 2 x SC Multi-mode (-40 ...+75 °C)	1240920000	524,00 €	1
IE-SW-BL08T-6TX-2ST	6 x RJ45, 2 x ST Multi-mode (-40 ...+75 °C)	1286570000	533,00 €	1
IE-SW-BL08-6TX-2SCS	6 x RJ45, 2 x SC Single-mode	1412110000	708,00 €	1
IE-SW-BL08T-6TX-2SCS	6 x RJ45, 2 x SC Single-mode (-40 ...+75 °C)	1412120000	1.000,00 €	1
IE-SW-VL16-16TX	16 x RJ45	1241000000	970,00 €	1
IE-SW-VL16T-16TX	16 x RJ45 (-40 ...+75 °C)	1286590000	1.100,00 €	1
IE-SW-VL09T-6TX-3SC	6 x RJ45, 3 x SC Multi-mode (-40 ...+75 °C)	1240980000	988,00 €	1
IE-SW-VL16-14TX-2SC	14 x RJ45, 2 x SC Multi-mode	1241030000	1.069,00 €	1
IE-SW-VL16-14TX-2ST	14 x RJ45, 2 x ST Multi-mode	1241050000	1.069,00 €	1
IE-SW-VL16T-14TX-2SC	14 x RJ45, 2 x SC Multi-mode (-40 ...+75 °C)	1286610000	1.292,00 €	1
IE-SW-VL16T-14TX-2ST	14 x RJ45, 2 x ST Multi-mode (-40 ...+75 °C)	1286620000	1.600,00 €	1
Gigabit Unmanaged - Yönetilemeyen Ethernet Switchler				
IE-SW-BL05-4GT-1GS	4 * RJ45 10/100/1000BaseT(X), 1 x combo-port	2435400000	333,00 €	1
IE-SW-VL08-8GT	8 x RJ45 10/100/1000BaseT(X)	1241270000	700,00 €	1
IE-SW-VL08T-8GT	8 x RJ45 10/100/1000BaseT(X) (-40 ...+75 °C)	1286860000	850,00 €	1
IE-SW-VL08-6GT-2GS	6 x RJ45 10/100/1000BaseT(X), 2 x combo-ports	1241280000	786,00 €	1
IE-SW-VL08T-6GT-2GS	6 x RJ45 10/100/1000BaseT(X), 2 x combo-ports (-40 ...+75 °C)	1286870000	847,00 €	1
POE Unmanaged - Yönetilemeyen Switchler				
Fast Ethernet POE				
IE-SW-BL06-2TX-4POE	2 x RJ45, 4 x RJ45 PoE	1241380000	507,00 €	1
IE-SW-BL06T-2TX-4POE	2 x RJ45, 4 x RJ45 PoE (-40 ...+75 °C)	1286920000	609,00 €	1
IE-SW-BL06-1TX-4POE-1SC	1 x RJ45, 4 x RJ45 PoE+, 1 x SC Multi-mode	1504250000	805,00 €	1
IE-SW-BL06T-1TX-4POE-1SC	1 x RJ45, 4 x RJ45 PoE+, 1 x SC Multi-mode (-40 ...+75 °C)	1504260000	933,00 €	1
IE-SW-BL06-1TX-4POE-1ST	1 x RJ45, 4 x RJ45 PoE+, 1 x ST Multi-mode	1504270000	805,00 €	1
IE-SW-BL06T-1TX-4POE-1ST	1 x RJ45, 4 x RJ45 PoE+, 1 x ST Multi-mode (-40 ...+75 °C)	1504290000	933,00 €	1
IE-SW-BL06-4POE-2SC	4 x RJ45 PoE+, 2 x SC Multi-mode	1504210000	958,00 €	1
IE-SW-BL06T-4POE-2SC	4 x RJ45 PoE+, 2 x SC Multi-mode (-40 ...+75 °C)	1504220000	1.110,00 €	1
IE-SW-BL06-4POE-2ST	4 x RJ45 PoE+, 2 x ST Multi-mode	1504230000	958,00 €	1
IE-SW-BL06T-4POE-2ST	4 x RJ45 PoE+, 2 x ST Multi-mode (-40 ...+75 °C)	1504240000	1.110,00 €	1
Gigabit POE				
IE-SW-BL05-1GT-4GTPOE	4 x RJ45 PoE+, 1 x RJ45 10/100/1000BaseT(X)	1504320000	1.062,00 €	1
IE-SW-BL05T-1GT-4GTPOE	4 x RJ45 10/100/1000BaseT(X) PoE+, 1 x RJ45 10/100/1000BaseT(X)(-40 ...+75 °C)	1504340000	1.232,00 €	1

Seeirinin devamı sayfa 95

Tip	Açıklama	Sipariş No	Fiyat/Birim	Ambalaj
IE-SW-BL05-1GS-4GTPOE	4 x RJ45 10/100/1000BaseT(X) PoE+, 1 x Slot 1000BaseSFP	1504360000	1.132,00 €	1
IE-SW-BL05T-1GS-4GTPOE	4 x RJ45 10/100/1000BaseT(X) PoE+, 1 x Slot 1000BaseSFP (-40 ...+75 °C)	1504380000	1.314,00 €	1
Managed - Yönetilen Ethernet Switchler				
IE-SW-VL05M-5TX	5 x RJ45	1504280000	620,00 €	1
IE-SW-VL05MT-5TX	5 x RJ45 (-40 ...+75 °C)	1504310000	625,00 €	1
IE-SW-VL08MT-8TX	8x RJ45 (-40 ...+75 °C)	1240940000	1.050,00 €	1
IE-SW-VL05M-3TX-2SC	3 x RJ45, 2 x SC Multi-mode	1504330000	1.025,00 €	1
IE-SW-VL05M-3TX-2ST	3 x RJ45, 2 x ST Multi-mode	1504370000	1.025,00 €	1
IE-SW-VL05MT-3TX-2SC	3 x RJ45, 2 x SC Multi-mode (-40 ...+75 °C)	1504350000	1.127,00 €	1
IE-SW-VL05MT-3TX-2ST	3 x RJ45, 2 x ST Multi-mode (-40 ...+75 °C)	1504390000	1.127,00 €	1
IE-SW-VL08MT-5TX-3SC	5 x RJ45, 3 x SC Multi-mode (-40 ...+75 °C)	1240970000	1.912,00 €	1
IE-SW-VL08MT-6TX-2ST	6 x RJ45, 2 x ST Multi-mode (-40 ...+75 °C)	1240990000	1.363,00 €	1
IE-SW-VL08MT-6TX-2SC	6 x RJ45, 2 x SC Multi-mode (-40 ...+75 °C)	1344770000	1.419,00 €	1
IE-SW-VL08MT-6TX-2SCS	6 x RJ45, 2 x SC Single-mode (-40 ...+75 °C)	1241020000	2.173,00 €	1
IE-SW-VL08MT-5TX-1SC-2SCS	5 x RJ45, 1 x SC Multi-mode, 2 x SC Single-mode (-40 ...+75 °C)	1345240000	2.122,00 €	1
IE-SW-PL08M-8TX	8 x RJ45	1241040000	1.158,00 €	1
IE-SW-PL08MT-8TX	8 x RJ45 (-40 ...+75 °C)	1286780000	1.318,00 €	1
IE-SW-PL08M-6TX-2SC	6 x RJ45, 2 x SC Multi-mode	1241070000	1.762,00 €	1
IE-SW-PL08MT-6TX-2SC	6 x RJ45, 2 x SC Multi-mode (-40 ...+75 °C)	1286790000	2.006,00 €	1
IE-SW-PL08M-6TX-2ST	6 x RJ45, 2 x ST Multi-mode	1241080000	1.762,00 €	1
IE-SW-PL08MT-6TX-2ST	6 x RJ45, 2 x ST Multi-mode (-40 ...+75 °C)	1286800000	2.006,00 €	1
IE-SW-PL08M-6TX-2SCS	6 x RJ45, 2 x SC Single-mode	1241090000	2.750,00 €	1
IE-SW-PL08MT-6TX-2SCS	6 x RJ45, 2 x SC Single-mode (-40 ...+75 °C)	1286810000	2.559,00 €	1
IE-SW-PL16M-16TX	16 x RJ45	1241100000	2.500,00 €	1
IE-SW-PL16MT-16TX	16x RJ45 (-40 ...+75 °C)	1286820000	2.370,00 €	1
IE-SW-PL16M-14TX-2SC	14 x RJ45, 2 x SC Multi-mode	1241120000	2.625,00 €	1
IE-SW-PL16MT-14TX-2SC	14 x RJ45, 2 x SC Multi-mode (-40 ...+75 °C)	1286830000	2.988,00 €	1
IE-SW-PL16M-14TX-2ST	14 x RJ45, 2 x ST Multi-mode	1241130000	2.625,00 €	1
IE-SW-PL16MT-14TX-2ST	14 x RJ45, 2 x ST Multi-mode (-40 ...+75 °C)	1286840000	2.988,00 €	1
EBR-MODULE RS232	Yedekleme modülü	1241430000	131,00 €	1
Gigabit Managed - Yönetilebilir Ethernet Switchler				
IE-SW-PL10M-3GT-7TX	3 x RJ45 10/100/1000BaseT(X) 7 x RJ45 10/100BaseT(X)	1241290000	1.842,00 €	1
IE-SW-PL10MT-3GT-7TX	3 x RJ45 10/100/1000BaseT(X) 7 x RJ45 10/100BaseT(X) (-40 ...+75 °C)	1286930000	2.097,00 €	1
IE-SW-PL10M-1GT-2GS-7TX	1 x RJ45 10/100/1000BaseT(X) 2 x Slots 1000BaseSFP, 7 x RJ45 10/100BaseT(X)	1241300000	1.842,00 €	1
IE-SW-PL10MT-1GT-2GS-7TX	1 x RJ45 10/100/1000BaseT(X) 2 x Slots 1000BaseSFP, 7 x RJ45 10/100BaseT(X) (-40 ...+75 °C)	1286940000	2.097,00 €	1
IE-SW-PL18M-2GC-16TX	16 x RJ45 10/100BaseT(X) 2 x combo-ports	1241320000	2.569,00 €	1
IE-SW-PL18MT-2GC-16TX	16 x RJ45 10/100BaseT(X) 2 x combo-ports (-40 ...+75 °C)	1286970000	2.925,00 €	1
IE-SW-PL18M-2GC14TX2SC	14 x RJ45 10/100BaseT(X) 2 x SC Multi-mode 100FX, 2 x combo-ports	1241330000	3.114,00 €	1
IE-SW-PL18MT-2GC14TX2SC	14 x RJ45 10/100BaseT(X) 2 x SC Multi-mode 100FX, 2 x combo-ports (-40 ...+75 °C)	1286990000	3.546,00 €	1
IE-SW-PL18M-2GC14TX2ST	14 x RJ45 10/100BaseT(X) 2 x ST Multi-mode, 2 x combo-ports	1241340000	3.114,00 €	1
IE-SW-PL18MT-2GC14TX2SCS	14 x RJ45 10/100BaseT(X) 2 x SC Single-mode, 2 x combo-ports (-40 ...+75 °C)	1287010000	3.872,00 €	1

Serinin devamı sayfa 96



IE-SW-VL05M-5TX



IE-SW-PL08M-8TX



IE-SW-PL16M-16TX



IE-SW-PL10M-3GT-7TX



IE-SW-PL10M-1GT-2GS-7TX



IE-SW-PL09M-5GC-4GT



IE-SFP-1GSXLC



IE-MCT-1RS232/485-1SC



IE-GW-MB-2TX-1RS232/485



IE-SR-6GT-LTE/4G-EU



IE-ANT-3G-806-2170-2-NF



IE-WL-BL-AP-CL-EU

Tip	Açıklama	Sipariş No	Fiyat/Birim	Ambalaj
IE-SW-PL18M-2GC14TX2SCS	14 x RJ45 10/100BaseT(X) 2 x SC Single-mode, 2 x combo-ports	1241350000	3.401,00 €	1
IE-SW-PL18MT-2GC14TX2ST	14 x RJ45 10/100BaseT(X) 2 x ST Multi-mode, 2 x combo-ports (-40 ...+75 °C)	1287000000	3.546,00 €	1

Full Gigabit Managed - Yönetilebilir Ethernet Switchler

IE-SW-PL09M-5GC-4GT	4 x RJ45 10/100/1000BaseT(X) 5 x combo-ports	1241370000	3.330,00 €	1
IE-SW-PL09MT-5GC-4GT	4 x RJ45 10/100/1000BaseT(X) 5 x combo-ports (-40 ...+75 °C)	1287020000	2.733,00 €	1
IE-SFP-1GSXLC	Multi-mode LC konektör SFP Modülü 500m	1241490000	284,00 €	1
IE-SFP-1GLSXL	Multi-mode LC konektör SFP Modülü 2 km	1241500000	462,00 €	1
IE-SFP-1GLXLC	Single-mode LC konektör SFP Modülü 10 km	1241510000	502,00 €	1
IE-SFP-1GLHXL	Single-mode LC konektör SFP Modülü 40 km	1241520000	1.540,00 €	1
EBR-MODULE RS232	Yedekleme modülü	1241430000	131,00 €	1

Seri / Ethernet Çevirici (COM/Server)

IE-CS-2TX-1RS232/485	2 x RJ45 ve 1 x RS232/422/485 Seri port girişi	1242080000	439,00 €	1
IE-CS-2TX-2RS232/485	2 x RJ45 ve 2 x RS232/422/485 Seri port girişi	1242090000	535,00 €	1

Seri / Fiber Çevirici

IE-MCT-1RS232/485-1SC	1 x RS232/422/485, 1 x SC multimode (-40 ...+75 °C)	1344760000	374,00 €	1
IE-MCT-1RS232/485-1ST	1 x RS232/422/485, 1 x ST multimode (-40 ...+75 °C)	1362950000	374,00 €	1

Not: Seri Port Üzerinden Haberleşen Cihazlar ile Ethernet Network Topolojileri Üzerinden Haberleşme / Watcdog timer ve Buzzer / Seri Port Ethernet ara yüzünde yüksek akımlara karşı 1kV izolasyon

Modbus TCP/Modbus Serial Gateway

IE-GW-MB-2TX-1RS232/485	2x RJ45, 1x DB9 (RS-232), 1x terminal (RS-422/485), IP 30, 0 °C...+55 °C	1504460000	577,00 €	1
IE-GW-MB-2TX-1RS232/485	2x RJ45, 1x DB9 (RS-232), 1x terminal (RS-422/485), IP 30, -40 °C...+75 °C	1504470000	836,00 €	1

Endüstriyel Router

IE-SR-2GT-LTE/4G-EU	Security/NAT/VPN/U-link Router, LTE / 4G modem, Gigabit Ethernet, 2x 10/100/1000BaseT(X)	2535930000	2.000,00 €	1
IE-SR-6GT-LTE/4G-EU	Security/NAT/VPN/U-link Router, LTE / 4G modem, Gigabit Ethernet, 6x 10/100/1000BaseT(X)	2535960000	2.093,00 €	1
IE-SR-6GT-LAN	Security/NAT/VPN/U-link Router, Gigabit Ethernet, 6x 10/100/1000BaseT(X)	2535940000	1.900,00 €	1
IE-SR-2GT-LAN	LAN / WAN VPN router, 2 x Gigabit Ethernet	1345270000	1.580,00 €	1
IE-SR-2GT-LAN-FN	LAN / WAN router, 2 x Gigabit Ethernet	1489940000	1.279,00 €	1

Not: Yüksek Güvenlikli Firewall, 2 adet Gigabit Port (LAN / WAN), NAT maskeleyme 1:1 ağ haritalama ve port yönlendirme, VPN fonksiyonu, Entegre 3G / UMTS modem

Endüstriyel 3G Router Antenleri

IE-ANT-3G-806-2170-2-NF	25W IP 54 (- 40 to 85 °C)	1491160000	162,00 €	1
IE-ANT-O-AH-360-5-NF	100W IP 66 (- 40 to 70 °C)	1367120000	408,00 €	1
IE-CC-NM-SMAM-2M	2m Anten kablosu N-type (male) -> SMA (male)	1491180000	51,00 €	1
IE-CC-NM-SMAM-4M	4m Anten kablosu N-type (male) -> SMA (male)	1491190000	57,00 €	1
IE-CC-NM-SMAM-6M	6m Anten kablosu N-type (male) -> SMA (male)	1491210000	66,00 €	1

Wireless-Access Point/Bridge/Client

IE-WL-BL-AP-CL-EU	Wireless Access Point/Client, IEEE 802.11 a/b/g/n, 0 °C...60 °C	2536600000	850,00 €	1
IE-WLT-BL-AP-CL-EU	Wireless Access Point/Client, IEEE 802.11 a/b/g/n, -40 °C...75 °C	2536650000	857,00 €	1
IE-WL-VL-AP-BR-CL-EU	Wireless Access Point/Bridge/Client, IEEE 802.11 a/b/g/n, -25 °C...60 °C	2536680000	1.100,00 €	1
IE-WLT-VL-AP-BR-CL-EU	Wireless Access Point/Bridge/Client, IEEE 802.11 a/b/g/n, -40 °C...75 °C	2536690000	1.096,00 €	1

Not: IE 802.11 a/b/g uyumlu, Bilgi Transfer Hızı 54Mbit/s (2,4 ve 5 GHz band hızlarını desteklemektedir) / Turbo ring Roaming (50ms) ile kusursuz kablosuz bağlantı / Multi-SSID, VLAN,STP,RSTP desteği / WEP,WPA/WPA2 ve WPA2 kriptolama ile yüksek data güvenliği / POE ile uyumlu / e-mail ve röle çıkışları ile alarm oluşturma.



IE-ANT-O-ABG-360-7-NF



IE-SW-IP67-5M12



IE-C6FP8LD0010M40M40-D



IE-C6FP8LD0005X40X40-Y



IE-C5ES8UG0010B41B41-E



IE-C5DD4UG0010MCSA20-E

Tip	Açıklama	Sipariş No	Fiyat/Birim	Ambalaj
Kablosuz (WLAN) Uygulamalar İçin Antenler (Wireless Access Point için)				
IE-ANT-O-ABG-360-7-NF	Omnidirectional 2,4 ve 5GHz, IP 68	1367130000	318,00 €	1
IE-ANT-O-AH-360-5-NF	100W IP 66 (- 40 to 70 °C)	1367120000	408,00 €	1
IE-ANT-O-BG-360-6-NF	Omnidirectional 2,4 IP 67	1367090000	388,00 €	1
IE-ANT-P-ABG-75-9-NF	Directional 2,4 ve 5GHz, IP 67	1367140000	281,00 €	1
IE-CC-NM-RPSMAM-4M	Anten kablosu N-Tip Erkek /RPSMA 4 metre	1367100000	135,00 €	1
IE-CC-NM-RPSMAM-2M	Anten kablosu N-Tip Erkek /RPSMA 2 metre	1367110000	125,00 €	1
Media Converter				
IE-MC-VL-1TX-1SC	1 x RJ45, 1 x SC Multimode	1241400000	448,00 €	1
IE-MC-VL-1TX-1ST	1 x RJ45, 1 x ST Multimode	1241410000	500,00 €	1
IE-MC-VL-1TX-1SCS	1 x RJ45, 1 x SC Singlemode	1241420000	699,00 €	1
Switch IP 67				
IE-SW-IP67-5M12	5 x M12 Konnektör girişi, IP 67 (-25 ...+60 °C)	1504410000	455,00 €	1
IE-SW-IP67T-5M12	5 x M12 Konnektör girişi, IP 67 (-40 ...+75 °C)	1504420000	527,00 €	1
Endüstriyel Ethernet Kabloları - Patch Kablo				
Cat. 6 Patch kablo				
IE-C6FP8LD0010M40M40-D	RJ45 IP20 CAT.6A / Class EA, LSZH 1m	1165940010	9,00 €	1
IE-C6FP8LD0020M40M40-D	RJ45 IP20 CAT.6A / Class EA, LSZH 2m	1165940020	13,00 €	1
IE-C6FP8LD0030M40M40-D	RJ45 IP20 CAT.6A / Class EA, LSZH 3m	1165940030	15,00 €	1
IE-C6FP8LD0040M40M40-D	RJ45 IP20 CAT.6A / Class EA, LSZH 4m	1165940040	18,00 €	1
IE-C6FP8LD0050M40M40-D	RJ45 IP20 CAT.6A / Class EA, LSZH 5m	1165940050	22,00 €	1
IE-C6FP8LD0200M40M40-D	RJ45 IP20 CAT.6A / Class EA, LSZH 20m	1165940200	70,00 €	1
Cat. 6 Crossover Patch kablo				
IE-C6FP8LD0005X40X40-Y	RJ45 IP20 CAT.6A / Class EA, LSZH 0.5m	1312160005	8,00 €	1
IE-C6FP8LD0010X40X40-Y	RJ45 IP20 CAT.6A / Class EA, LSZH 1m	1312160010	9,50 €	1
IE-C6FP8LD0020X40X40-Y	RJ45 IP20 CAT.6A / Class EA, LSZH 2m	1312160020	12,00 €	1
IE-C6FP8LD0030X40X40-Y	RJ45 IP20 CAT.6A / Class EA, LSZH 3m	1312160030	15,00 €	1
IE-C6FP8LD0050X40X40-Y	RJ45 IP20 CAT.6A / Class EA, LSZH 5m	1312160050	22,00 €	1
IE-C6FP8LD0100X40X40-Y	RJ45 IP20 CAT.6A / Class EA, LSZH 10m	1312160100	38,00 €	1
Endüstriyel Ethernet Kabloları - IP 67 - 4 x 2 x AWG 26/7				
IE-C5ES8UG0010B41B41-E	RJ45 IP67, V01 metal 1m	1066850000	81,85 €	1
IE-C5ES8UG0020B41B41-E	RJ45 IP67, V01 metal 2m	1066860000	87,70 €	1
IE-C5ES8UG0050B41B41-E	RJ45 IP67, V01 metal 5m	1066870000	105,00 €	1
IE-C5ES8UG0100B41B41-E	RJ45 IP67, V01 metal 10m	1066880000	134,00 €	1
Endüstriyel Ethernet Kabloları - M12 / X				
M12 / M12 - 4 x 2 x AWG 22/7				
IE-C5DD4UG0005MCSMCS-E	40...70 °C - 0.5 m	1025950005	59,10 €	1
IE-C5DD4UG0015MCSMCS-E	40...70 °C - 1.5 m	1025950015	65,45 €	1
IE-C5DD4UG0030MCSMCS-E	40...70 °C - 3 m	1025950030	75,05 €	1
IE-C5DD4UG0050MCSMCS-E	40...70 °C - 5 m	1025950050	90,00 €	1
IE-C5DD4UG0100MCSMCS-E	40...70 °C - 10 m	1025950100	106,00 €	1
IE-C5DD4UG0015MSSMCS-E	40...70 °C - 1.5 m	1059330015	65,45 €	1
IE-C5DD4UG0030MSSMCS-E	40...70 °C - 3 m	1059330030	75,05 €	1
IE-C5DD4UG0050MSSMCS-E	40...70 °C - 5 m	1059330050	87,80 €	1
IE-C5DD4UG0100MSSMCS-E	40...70 °C - 10 m	1059330100	120,00 €	1
M12 / RJ45				
IE-C5DD4UG0010MCSA20-E	40...70 °C - 1 m	1044470010	69,40 €	1
IE-C5DD4UG0015MCSA20-E	40...70 °C - 1.5 m	1044470015	72,55 €	1
IE-C5DD4UG0030MCSA20-E	40...70 °C - 3 m	1044470030	82,15 €	1
IE-C5DD4UG0050MCSA20-E	40...70 °C - 5 m	1044470050	94,95 €	1
IE-C5DD4UG0100MCSA20-E	40...70 °C - 10 m	1044470100	127,00 €	1



IE-C5DD4UG0015MCSXXX-X



IE-CT



AM 12



VDATA CAT6



IE-FCM-RJ45-C



IE-PS-RJ45-FH-BK



IE-TO-RJ45-C

Tip	Açıklama	Sipariş No	Fiyat/Birim	Ambalaj
M12 / Boş				
IE-C5DD4UG0015MCSXXX-X	-40...70 °C - 1.5 m	1025940015	37,55 €	1
IE-C5DD4UG0030MCSXXX-X	-40...70 °C - 3 m	1025940030	47,10 €	1
IE-C5DD4UG0050MCSXXX-X	-40...70 °C - 5 m	1025940050	59,85 €	1
IE-C5DD4UG0100MCSXXX-X	-40...70 °C - 10 m	1025940100	91,75 €	1

Ethernet Kablo Test Cihazı

IE-CT	Ethernet Kablosu Test Cihazı	8808420000	4.500,00 TL	1
LAN USB TESTER	LAN ve USB bağlantıları için network kablo test aleti, LED skala/ RJ45, USB A, USB B bağlantı tipi/max 1000 mt	9205400000	1.263,00 TL	1

Ethernet Konnektörleri için El Aletleri

PUNCH DOWN TOOL PDT	Pach Panel Çakma	9013970000	601,00 TL	1
TT 8 RS MP 8	Sıkma	9202800000	6.407,00 TL	1
AM 12	0.5...12.5mm çap aralığına sahip UTP ve STP data kabloları için	9030060000	560,00 TL	1

Data Hatları için OVP Modülü (Parafudr)

VDATA CAT6	Data hatları için aşırı gerilim koruma modülü	1348590000	141,00 €	1
------------	---	------------	----------	---

Basic Line Switchler için Kablo Tutucu

IE-CFK-05	Basic Line 5 Port Switchler için Kablo Tutucu	1339610000	51,00 €	1
-----------	---	------------	---------	---

IE-FrontCom (IP65)

IE-FCM-RJ45-C	RJ45 Coupling (Cat.6A / Class EA)	1018790000	25,00 €	1
IE-FCM-USB-A	USB Coupling Type A	1018840000	21,00 €	1
IE-FCM-USB-AB	USB Coupling Type AB	1222550000	29,00 €	1

RJ45 Fiş (IP20) - El Aleti Gerektirmeyen Montaj

IE-PS-RJ45-FH-BK	RJ45 Fiş, Cat6a / Class EA, Profinet, TIA - 568 A/B	1963600000	20,00 €	10
IE-PS-RJ45-FH-BK-A	RJ45 Fiş, Cat6a / Class EA, TIA - 568 A	1132040000	19,70 €	10
IE-PS-RJ45-FH-BK-B	RJ45 Fiş, Cat6a / Class EA, TIA - 568 B	1132050000	27,00 €	10
IE-PS-RJ45-FH-BK-P	RJ45 Fiş, Cat6a / Class EA, Profinet	1132060000	22,40 €	10
IE-BI-RJ45-FJ-P	RJ45 Soket, Profinet	1963830000	22,00 €	1

Raya Montaj RJ45 Klemens

IE-TO-RJ45-C	RJ45 Fiş, Cat6a / Class EA, Profinet	8946920000	38,00 €	1
IE-TO-SCRJ-SM	Fiberoptik Coupling, Profinet	8947000000	40,15 €	1
IE-TO-USB	USB Coupling	8946960000	25,90 €	1

M12 Ethernet Konnektör / Fiş

SAISM-4/8S-M12 4P D-ZF	M12 Düz, Erkek 4 Kutuplu (IP67)	1892120001	32,20 €	1
SAISW-4/8S-M12 4P D-ZF	M12 Açılı, Erkek 4 Kutuplu, Yaylı Bağlantı (IP67)	1803930001	34,15 €	1
SAISM-4/8S-M12-4P D-COD	M12 Düz, Erkek 4 Kutuplu (IP67)	1892120000	22,00 €	1

M12 Ethernet Konnektör / Soket

SAIBM-4/8S-M12 4P D-ZF	M12 Düz, Dişi 4 Kutuplu, Yaylı Bağlantı (IP67)	1892130001	33,45 €	1
SAIBM-4/8S-M12-4P D-COD	M12 Düz, Dişi 4 Kutuplu (IP67)	1892130000	19,00 €	1

Term Serisi Röleler

Geliştirilmiş mekanik ve elektronik fonksiyonları ile ray üzerinde simetrik ve her katı köpülenebilir şekilde kullanabileceğiniz Term serisi röleler panolarınızın güvenlik ve kalitesini bir üst sınıfa taşımaktadır. Ayırıcı mekanizma aynı zamanda geniş ve görsel algılamayı kolaylaştıracak şekilde LED gösterge olarak tasarlanmış olup kontak bilgisini rahatça okumanızı sağlar. Aynı taban üzerinde hem mekanik hem de optokuplör röle kullanımı mümkündür.

- Tek veya çift kontak yapısı
- Simetrik tasarım ve yuvarlatılmış keskin köşeler
- Geniş LED gösterge
- Universal giriş gerilimi (24...230 V AC/ DC)
- Anlaşılır markalama
- Her katı tarak köprü ile köpülenebilir yapı
- Montaj kolaylığı için ray üzerinde yüksek duruş

Rider Serisi

Weidmüller'in yüksek performans gerektiren uygulamalar için push-in bağlantı teknolojisi ile donattığı bu yeni RCI serisi vidalı bağlantıya göre %75 zaman tasarrufu sağlar. Ayrıca vida bağlantılı olarak da temin edilebilir.

- Sağlam : Endüstriyel tip kalın pinler
- Güvenli : Diyot korumalı LED
- Pratik : Mekanik kontakların testi için test butonu
- Hızlı : Push-In soketler
- Kolay : ZQV vidasız üst köprüler
- Komple veya ayrı ayrı sipariş edilebilme imkanı





RCL314024



SRC 2CO



RCI314024



SRC-I 2CO

Tip	Giriş	Çıkış	Sipariş No	Fiyat/Birim	Ambalaj
RCL Tip Röleler					
1 Kutuplu Enversör Kontak 16 A, 250V					
RCL314024	24 VDC / 16,7 mA	250 V / 16 A, 1CO	8693260000	26,00 TL	20
RCL314524	24 VAC / 31,6 mA	250 V / 16 A, 1CO	8693500000	29,80 TL	20
RCL314615	115 VAC / 6,6 mA	250 V / 16 A, 1CO	8693890000	55,55 TL	20
RCL314730	230 VAC / 3,2 mA	250 V / 16 A, 1CO	8693320000	59,15 TL	20
2 Kutuplu Enversör Kontak 2x8 A, 250 V					
RCL424024	24 VDC / 16,7 mA DC	250 V / 2x8 A, 2CO	4058570000	26,75 TL	20
RCL424524	24 VAC / 31,6 mA AC	250 V / 2x8 A, 2CO	4058600000	34,40 TL	20
RCL424615	115 VAC / 6,6 mA AC	250 V / 2x8 A, 2CO	4058610000	55,00 TL	20
RCL424730	230 VAC / 3,2 mA AC	250 V / 2x8 A, 2CO	4058630000	53,20 TL	20
RCL Röle Soketleri					
SRC 2CO	RCL Vida Bağlantılı Röle Soketi		8690830000	40,00 TL	10
SRC CLIP LP	Plastik Klips		8691090000	4,26 TL	10
RCL Röle LED ve Diyot Modülleri					
RIM 2 6/24VDC	Diyotlu LED Modülü		8690950000	24,40 TL	10
RIM 3 6/24VUC	LED Modülü		8691010000	29,00 TL	10
RIM 3 110/230VUC	LED Modülü		8691030000	29,00 TL	10
RIM 4 110/230VUC	Varistörlü LED Modülü		8691060000	41,40 TL	10
Not: RCL tipi röle gruplarında; röle, soket, LED ve koruma aksesuarları ayrı ayrı mevcuttur.					
RCI Tip Röleler					
1 Kutuplu Enversör Kontak 16 A, 250V					
RCI314024	24 VDC / 16,7 mA	250 V / 16 A, 1CO	8869810000	40,65 TL	10
RCI314AC4	24 VDC / 16,7 mA, LED+Diyod	250 V / 16 A, 1CO	8870100000	55,05 TL	10
RCI314524	24 VAC / 31,6 mA	250 V / 16 A, 1CO	8869840000	50,00 TL	10
RCI314R24	24 VAC / 31,6 mA, LED	250 V / 16 A, 1CO	8870130000	67,10 TL	10
RCI314615	115 VAC / 6,6 mA	250 V / 16 A, 1CO	8869850000	55,55 TL	10
RCI314S15	115 VAC / 6,6 mA, LED	250 V / 16 A, 1CO	8870140000	76,60 TL	10
RCI314730	230 VAC / 3,2 mA	250 V / 16 A, 1CO	8869860000	55,90 TL	10
RCI314T30	230 VAC / 3,2 mA, LED	250 V / 16 A, 1CO	8870150000	115,50 TL	10
2 Kutuplu Enversör Kontak 2x8 A, 250 V					
RCI424024	24 VDC / 16,7 mA	250 V / 2x8 A, 2CO	8869890000	34,20 TL	10
RCI424AC4	24 VDC / 16,7 mA, LED+Diyod	250 V / 2x8 A, 2CO	8870180000	51,35 TL	10
RCI424524	24 VAC / 31,6 mA	250 V / 2x8 A, 2CO	8869920000	38,75 TL	10
RCI424R24	24 VAC / 31,6 mA, LED	250 V / 2x8 A, 2CO	8870210000	51,35 TL	10
RCI424615	115 VAC / 6,6 mA	250 V / 2x8 A, 2CO	8869930000	74,80 TL	10
RCI424S15	115 VAC / 6,6 mA, LED	250 V / 2x8 A, 2CO	8870220000	97,40 TL	10
RCI424730	230 VAC / 3,2 mA	250 V / 2x8 A, 2CO	8869940000	76,25 TL	10
RCI484T30	230 VAC / 3,2 mA, LED+Test Butonu	250 V / 2x8 A, 2CO	8870370000	91,75 TL	10
Not: RCI Röleler Endüstriyel uygulamalar için kalın pinli olarak tasarlanmıştır. Opsiyonel olarak test soketli ve LED'li olarak seçilebilir.					
RCI Röle Soketleri					
SRC-I 2CO	RCI Vida Bağlantılı Röle Soketi		8869490000	40,00 TL	10
SRC-I 2CO P	RCI Push In Bağlantılı Röle Soketi		8869500000	58,45 TL	10
SRC-I CLIP HP	Klips		8869510000	3,84 TL	10
RCI LED ve Diyot Modülleri					
RIM-I 2 6/24VDC	Diyotlu LED Modülü		8869590000	31,90 TL	10
RIM-I 3 6/24VUC	LED Modülü		8869630000	49,75 TL	10
RIM-I 3 110/230VUC	LED Modülü		8869650000	52,45 TL	10
SRC-I QV P	Üst Köprü		8870840000	16,40 TL	10
Not: RCI tip röleler ile ayrıca Push In bağlantılı soketler kullanılabilir. Klips, LED ve koruma aksesuarları opsiyoneldir. Yanyana kullanılan röleler SRC-I QV ile köprülenebilir.					



RCM270024



RCM570110



SCM 4CO



SCM-I 4CO N

Tip	Giriş	Çıkış	Sipariş No	Fiyat/Birim	Ambalaj
RCM Tipi Minyatür Endüstriyel Röleler					
2 Kutuplu Enversör Kontak 2x12 A, 250 V					
RCM270024	24 VDC / 31,3 mA	250 V / 2x12 A, 2CO	8689860000	60,00 TL	10
RCM270AC4	24 VDC / 31,3 mA, LED+Diyot	250 V / 2x12 A, 2CO	8957030000	78,30 TL	10
RCM270524	24 VAC / 41,6 mA	250 V / 2x12 A, 2CO	8689760000	63,85 TL	10
RCM270R24	24 VAC / 41,6 mA, LED	250 V / 2x12 A, 2CO	8689770000	137,90 TL	10
RCM270615	115 VAC / 8,8 mA	250 V / 2x12 A, 2CO	8689800000	118,35 TL	10
RCM270S15	115 VAC / 8,8 mA, LED	250 V / 2x12 A, 2CO	8689810000	91,45 TL	10
RCM270730	230 VAC / 4,3 mA	250 V / 2x12 A, 2CO	8689820000	66,00 TL	10
RCM270T30	230 VAC / 4,3 mA, LED	250 V / 2x12 A, 2CO	8689830000	114,50 TL	10
3 Kutuplu Enversör Kontak 3x10 A, 250V					
RCM370024	24 VDC / 31,3 mA	250 V / 3x10 A, 3CO	8690040000	63,85 TL	10
RCM370AC4	24 VDC / 31,3 mA, LED+Diyot	250 V / 3x10 A, 3CO	8957100000	82,70 TL	10
RCM370524	24 VAC / 41,6 mA	250 V / 3x10 A, 3CO	8690030000	63,85 TL	10
RCM370R24	24 VAC / 41,6 mA, LED	250 V / 3x10 A, 3CO	8689950000	141,55 TL	10
RCM370615	115 VAC / 8,8 mA	250 V / 3x10 A, 3CO	8689980000	140,00 TL	10
RCM370S15	115 VAC / 8,8 mA, LED	250 V / 3x10 A, 3CO	8689990000	155,30 TL	10
RCM370730	230 VAC / 4,3 mA	250 V / 3x10 A, 3CO	8690000000	67,00 TL	10
RCM370T30	230 VAC / 4,3 Ma, LED	250 V / 3x10 A, 3CO	8690010000	186,85 TL	10
4 Kutuplu Enversör Kontak 4x6 A, 250 V					
RCM570024	24 VDC / 31,3 mA	250 V / 4x6 A, 4CO	8690200000	63,85 TL	10
RCM570AC4	24 VDC / 31,3 mA, LED+Diyot	250 V / 4x6 A, 4CO	8957170000	82,70 TL	10
RCM570524	24 VAC / 41,6 mA	250 V / 4x6 A, 4CO	8690110000	71,20 TL	10
RCM570R24	24 VAC / 41,6 mA, LED	250 V / 4x6 A, 4CO	8690120000	95,00 TL	10
* RCM570110	110 VDC / 6,8 mA	250 V / 4x6 A, 4CO	8074700000	76,90 TL	10
RCM570615	115 VAC / 8,8 mA	250 V / 4x6 A, 4CO	1180800000	82,70 TL	10
RCM570S15	115 VAC / 8,8 mA, LED	250 V / 4x6 A, 4CO	8690150000	158,95 TL	10
RCM570730	230 VAC / 4,3 mA	250 V / 4x6 A, 4CO	1181100000	65,00 TL	10
RCM570T30	230 VAC / 4,3 mA, LED	250 V / 4x6 A, 4CO	8690160000	82,00 TL	10
RCM Röle Soket ve Klipsleri					
SCM 2CO	2 Kutuplu Vida Bağlantılı Röle Soketi		8690880000	42,00 TL	10
SCM 3CO	3 Kutuplu Vida Bağlantılı Röle Soketi		8690890000	41,00 TL	10
SCM 4CO	4 Kutuplu Vida Bağlantılı Röle Soketi		8690900000	47,00 TL	10
SCM CLIP P	Plastik Klips (Vidalı bağlantı için)		8691110000	4,50 TL	10
SCM-I 2CO P	2 Kutuplu Push In Bağlantılı Röle Soketi		8876220000	94,35 TL	10
SCM-I 4CO P	4 Kutuplu Push In Bağlantılı Röle Soketi		8869430000	103,10 TL	10
SCM-I CLIP P	Plastik Klips (Push In İçin)		8869440000	4,45 TL	10
* SCM-I 4CO N	4 Kutuplu Vida Bağlantılı Röle Soketi		8869390000	45,00 TL	10
RCM Röle LED ve Diyet Modülleri					
RIM 2 6/24VDC	Diyotlu LED Modülü		8690950000	24,40 TL	10
RIM 3 6/24VUC	LED Modülü		8691010000	29,00 TL	10
RIM 3 110/230VUC	LED Modülü		8691030000	29,00 TL	10
RIM 4 6/24VUC	Varistörlü LED Modülü (Vidalı bağlantı için)		8691040000	49,75 TL	10
RIM 4 110/230VUC	Varistörlü LED Modülü		8691060000	41,40 TL	10
RIM-I 2 6/24VDC	Diyotlu LED Modülü		8869590000	31,90 TL	10
RIM-I 3 6/24VUC	LED Modülü		8869630000	49,75 TL	10
RIM-I 3 110/230VUC	LED Modülü		8869650000	52,45 TL	10
SCM-I QV P	2 Kutuplu Üst Köprü (Push In İçin)	10A / 240VAC	8870850000	17,40 TL	10

Not: RCM tipi minyatür röleler için vidalı ve Push In soketler, ledler, koruma devreleri ve üst köprüler.



RRD321012



SRD-I 3CO



RCIKIT 24VDC 1CO LD



RCMKIT-I 24VDC 3CO LD



DRI314012

Tip	Giriş	Çıkış	Sipariş No	Fiyat/Birim	Ambalaj
RRD Serisi Güç Röleleri					
* RRD321012	12VDC / 109.1mA	10A / 240VAC	8799030000	148,25 TL	25
* RRD321024	24VDC / 50.5mA	10A / 240VAC	8690610000	125,75 TL	25
* RRD321048	48VDC / 24mA	10A / 240VAC	8690630000	154,05 TL	25
* RRD321110	110VDC / 11mA	10A / 240VAC	8690650000	138,00 TL	25
* RRD321220	220VDC / 5,5mA	10A / 240VAC	7940007742	225,80 TL	25
* RRD326230	230 VAC / 5,1mA	10A / 240VAC	8690570000	186,85 TL	25
* SRD-I 3CO	3 Kontak RRD Röle soketi (11 Pin)		8869350000	49,80 TL	25

Not: 2 kontak röleler için bizimle iletişime geçebilirsiniz.

Endüstriyel Tip Röle Kitleri

RCI TİP RÖLELER, 1 Kutuplu Enversör Kontak 16 A, 250 V

RCIKIT 24VDC 1CO LD	24 VDC / 16,7 mA, LED+Diyod	250 V / 16 A, 1CO	8871000000	123,35 TL	10
RCIKIT 24VAC 1CO LD	24 VAC / 31,6 mA, LED	250 V / 16 A, 1CO	8871010000	140,35 TL	10
RCIKIT 115VAC 1CO LD	115 VAC / 6,6 mA, LED	250 V / 16 A, 1CO	8897090000	153,15 TL	10
RCIKIT 230VAC 1CO LD	230 VAC / 3,2 mA, LED	250 V / 16 A, 1CO	8871020000	186,85 TL	10

RCI TİP RÖLELER, 2 Kutuplu Enversör Kontak 2x8 A, 250 V

RCIKIT 24VDC 2CO LD	24 VDC / 16,7 mA, LED+Diyod	250 V / 2x8 A, 2CO	8871030000	127,00 TL	10
RCIKIT 24VAC 2CO LD	24 VAC / 31,6 mA, LED	250 V / 2x8 A, 2CO	8871040000	166,70 TL	10
RCIKIT 115VAC 2CO LD	115 VAC / 6,6 mA, LED	250 V / 2x8 A, 2CO	8897100000	161,10 TL	10
RCIKIT 230VAC 2CO LD	230 VAC / 3,2 mA, LED	250 V / 2x8 A, 2CO	8871050000	158,40 TL	10

RCM TİP MİNYATÜR ENDÜSTRİYEL RÖLELER, 2 Kutuplu Enversör Kontak 2x12 A, 250 V

RCMKIT-I 24VDC 2CO LD	24 VDC / 31,3 mA, LED	250 V / 2x12 A, 2CO	8920940000	204,00 TL	10
RCMKIT-I 24VAC 2CO LD	24 VAC / 41,6 mA, LED	250 V / 2x12 A, 2CO	8920950000	270,00 TL	10
RCMKIT-I 115VAC 2CO LD	115 VAC / 8,8 mA, LED	250 V / 2x12 A, 2CO	8920960000	250,45 TL	10
RCMKIT-I 230VAC 2CO LD	230 VAC / 4,3 mA, LED	250 V / 2x12 A, 2CO	8920970000	231,85 TL	10

RCM TİP MİNYATÜR ENDÜSTRİYEL RÖLELER, 3 Kutuplu Enversör Kontak 3x10 A, 250 V

RCMKIT-I 24VDC 3CO LD	24 VDC / 31,3 mA, LED	250 V / 3x10 A, 3CO	8920980000	267,50 TL	10
RCMKIT-I 24VAC 3CO LD	24 VAC / 41,6 mA, LED	250 V / 3x10 A, 3CO	8920990000	238,90 TL	10
RCMKIT-I 115VAC 3CO LD	115 VAC / 8,8 mA, LED	250 V / 3x10 A, 3CO	8921010000	155,20 TL	10
RCMKIT-I 230VAC 3CO LD	230 VAC / 4,3 mA, LED	250 V / 3x10 A, 3CO	8921020000	245,90 TL	10

RCM TİP MİNYATÜR ENDÜSTRİYEL RÖLELER, 4 Kutuplu Enversör Kontak 4x6 A, 250 V

RCMKIT-I 24VDC 4CO LD	24 VDC / 31,3 mA, LED	250 V / 4x6 A, 4CO	8921030000	216,00 TL	10
RCMKIT-I 24VAC 4CO LD	24 VAC / 41,6 mA, LED	250 V / 4x6 A, 4CO	8921040000	241,00 TL	10
RCMKIT-I 115VAC 4CO LD	115 VAC / 8,8 mA, LED	250 V / 4x6 A, 4CO	8921050000	228,50 TL	10
RCMKIT-I 230VAC 4CO LD	230 VAC / 4,3 mA, LED	250 V / 4x6 A, 4CO	8921060000	212,80 TL	10

DRI Serisi Röleler

1CO Kontak, 10 A / 250 V AC

Röle	Giriş	Çıkış	Sipariş No	Fiyat/Birim	Ambalaj
DRI314012	12 VDC / 44,4 mA	250 V / 10 A, 1CO	7760056296	33,20 TL	20
DRI314024	24 VDC / 21,8 mA	250 V / 10 A, 1CO	7760056297	33,95 TL	20
DRI314048	48 VDC / 11,2 mA	250 V / 10 A, 1CO	7760056298	37,20 TL	20
DRI314110	110 VDC / 4,8 mA	250 V / 10 A, 1CO	7760056299	40,75 TL	20
DRI314524	24 VAC / 50 mA	250 V / 10 A, 1CO	7760056300	44,85 TL	20
DRI314615	115 VAC / 9,3 mA	250 V / 10 A, 1CO	7760056301	43,85 TL	20
DRI314730	230 VAC / 4,9 mA	250 V / 10 A, 1CO	7760056302	44,85 TL	20

Röle + LED

DRI314012L	12 VDC / 44,4 mA, LED	250 V / 10 A, 1CO	7760056303	38,70 TL	20
DRI314024L	24 VDC / 21,8 mA, LED	250 V / 10 A, 1CO	7760056304	39,60 TL	20
DRI314048L	48 VDC / 11,2 mA, LED	250 V / 10 A, 1CO	7760056305	42,90 TL	20
DRI314110L	110 VDC / 4,8 mA, LED	250 V / 10 A, 1CO	7760056306	45,70 TL	20

Serinin devamı sayfa 103



DRI314012LD



DRI314524LT



DRI314012LTD



DRI424012L



DRI424012LD



DRI424524LT



DRI424012LTD

Tip	Giriş	Çıkış	Sipariş No	Fiyat/Birim	Ambalaj
DRI314524L	24 VAC / 44,4 mA, LED	250 V / 10 A, 1CO	7760056307	50,00 TL	20
DRI314615L	115 VAC / 44,4 mA, LED	250 V / 10 A, 1CO	7760056308	48,90 TL	20
DRI314730L	230 VAC / 44,4 mA, LED	250 V / 10 A, 1CO	7760056309	50,00 TL	20
Röle + LED + Diyot					
DRI314012LD	12 VDC / 44,4 mA, LED + Diyot	250 V / 10 A, 1CO	7760056310	38,70 TL	20
DRI314024LD	24 VDC / 21,8 mA, LED + Diyot	250 V / 10 A, 1CO	7760056311	39,60 TL	20
DRI314048LD	48 VDC / 11,2 mA, LED + Diyot	250 V / 10 A, 1CO	7760056312	41,95 TL	20
DRI314110LD	110 VDC / 4,8 mA, LED + Diyot	250 V / 10 A, 1CO	7760056313	45,70 TL	20
Röle + LED + Test Butonu					
DRI314524LT	24 VAC / 50 mA, LED + Test	250 V / 10 A, 1CO	7760056318	55,65 TL	20
DRI314615LT	115 VAC / 9,3 mA, LED + Test	250 V / 10 A, 1CO	7760056319	54,40 TL	20
DRI314730LT	230 VAC / 4,9 mA, LED + Test	250 V / 10 A, 1CO	7760056320	57,15 TL	20
Röle + LED + Diyot + Test Butonu					
DRI314012LTD	12 VDC / 44,4 mA, LED + Diyot + Test	250 V / 10 A, 1CO	7760056314	43,85 TL	20
DRI314024LTD	24 VDC / 21,8 mA, LED + Diyot + Test	250 V / 10 A, 1CO	7760056315	44,85 TL	20
DRI314048LTD	48 VDC / 11,2 mA, LED + Diyot + Test	250 V / 10 A, 1CO	7760056316	46,90 TL	20
DRI314110LTD	110 VDC / 4,8 mA, LED + Diyot + Test	250 V / 10 A, 1CO	7760056317	51,30 TL	20
2CO Kontak, 5 A / 250 V AC					
Röle					
DRI424012	12 VDC / 44,4 mA	250 V / 2x5 A, 2CO	7760056321	36,35 TL	20
DRI424024	24 VDC / 21,8 mA	250 V / 2x5 A, 2CO	7760056322	37,20 TL	20
DRI424048	48 VDC / 11,2 mA	250 V / 2x5 A, 2CO	7760056323	38,70 TL	20
DRI424110	110 VDC / 4,8 mA	250 V / 2x5 A, 2CO	7760056324	42,55 TL	20
DRI424524	24 VAC / 50 mA	250 V / 2x5 A, 2CO	7760056325	46,75 TL	20
DRI424615	115 VAC / 9,3 mA	250 V / 2x5 A, 2CO	7760056326	45,70 TL	20
DRI424730	230 VAC / 4,9 mA	250 V / 2x5 A, 2CO	7760056327	48,00 TL	20
Röle + LED					
DRI424012L	12 VDC / 44,4 mA, LED	250 V / 2x5 A, 2CO	7760056328	43,85 TL	20
DRI424024L	24 VDC / 21,8 mA, LED	250 V / 2x5 A, 2CO	7760056329	44,85 TL	20
DRI424048L	48 VDC / 11,2 mA, LED	250 V / 2x5 A, 2CO	7760056330	46,90 TL	20
DRI424110L	110 VDC / 4,8 mA, LED	250 V / 2x5 A, 2CO	7760056331	51,30 TL	20
DRI424524L	24 VAC / 44,4 mA, LED	250 V / 2x5 A, 2CO	7760056332	54,40 TL	20
DRI424615L	115 VAC / 44,4 mA, LED	250 V / 2x5 A, 2CO	7760056333	54,40 TL	20
DRI424730L	230 VAC / 44,4 mA, LED	250 V / 2x5 A, 2CO	7760056334	57,15 TL	20
Röle + LED + Diyot					
DRI424012LD	12 VDC / 44,4 mA, LED + Diyot	250 V / 2x5 A, 2CO	7760056335	43,85 TL	20
DRI424024LD	24 VDC / 21,8 mA, LED + Diyot	250 V / 2x5 A, 2CO	7760056336	44,85 TL	20
DRI424048LD	48 VDC / 11,2 mA, LED + Diyot	250 V / 2x5 A, 2CO	7760056337	46,90 TL	20
DRI424110LD	110 VDC / 4,8 mA, LED + Diyot	250 V / 2x5 A, 2CO	7760056338	51,30 TL	20
Röle + LED + Test Butonu					
DRI424524LT	24 VAC / 50 mA, LED + Test	250 V / 2x5 A, 2CO	7760056343	60,75 TL	20
DRI424615LT	115 VAC / 9,3 mA, LED + Test	250 V / 2x5 A, 2CO	7760056344	62,35 TL	20
DRI424730LT	230 VAC / 4,9 mA, LED + Test	250 V / 2x5 A, 2CO	7760056345	62,35 TL	20
Röle + LED + Diyot + Test Butonu					
DRI424012LTD	12 VDC / 44,4 mA, LED + Diyot + Test	250 V / 2x5 A, 2CO	7760056339	48,90 TL	20
DRI424024LTD	24 VDC / 21,8 mA, LED + Diyot + Test	250 V / 2x5 A, 2CO	7760056340	50,00 TL	20
DRI424048LTD	48 VDC / 11,2 mA, LED + Diyot + Test	250 V / 2x5 A, 2CO	7760056341	51,90 TL	20
DRI424110LTD	110 VDC / 4,8 mA, LED + Diyot + Test	250 V / 2x5 A, 2CO	7760056342	56,45 TL	20



SDI 1CO



DRM270012



DRM570012

Tip	Giriş	Çıkış	Sipariş No	Fiyat/Birim	Ambalaj
DRI Tip Röle Soket ve Klips					
SDI 1CO	DRI Vida Bağlantılı 1CO Röle Soketi		7760056350	28,20 TL	10
SDI 2CO	DRI Vida Bağlantılı 2CO Röle Soketi		7760056351	30,25 TL	10
SDI CLIP	Plastik Klip		7760056352	3,23 TL	10
SDI 1CO P	Push-in bağlantılı 1CO Röle Soketi		7760056364	47,05 TL	20
SDI 2CO P	Push-in bağlantılı 2CO Röle Soketi		7760056365	50,80 TL	20

DRM Serisi Röleler
2 CO Kontak, 10 A / 250 V AC

DRM270012	12VDC/75mA	10 A / 250 V AC, 2 CO	7760056050	39,60 TL	20
DRM270024	24VDC/36,8mA	10 A / 250 V AC, 2 CO	7760056051	39,60 TL	20
DRM270048	48VDC/18,5mA	10 A / 250 V AC, 2 CO	7760056052	40,40 TL	20
DRM270110	110VDC/10mA	10 A / 250 V AC, 2 CO	7760056053	44,65 TL	20
DRM270220	220VDC/5,2mA	10 A / 250 V AC, 2 CO	7760056054	57,75 TL	20
DRM270524	24VAC/62,4mA @50Hz	10 A / 250 V AC, 2 CO	7760056055	40,40 TL	20
DRM270548	48VAC/33,3mA @50Hz	10 A / 250 V AC, 2 CO	7760056056	40,40 TL	20
DRM270615	115VAC/12,6mA @50Hz	10 A / 250 V AC, 2 CO	7760056057	40,40 TL	20
DRM270730	230VAC/6,1mA @50Hz	10 A / 250 V AC, 2 CO	7760056058	44,65 TL	20
DRM270012L	12VDC +LED/75mA	10 A / 250 V AC, 2 CO	7760056059	42,35 TL	20
DRM270024L	24VDC+LED/36,8mA	10 A / 250 V AC, 2 CO	7760056060	42,35 TL	20
DRM270048L	48VDC+LED/18,5mA	10 A / 250 V AC, 2 CO	7760056061	43,20 TL	20
DRM270110L	110VDC+LED/10mA	10 A / 250 V AC, 2 CO	7760056062	48,00 TL	20
DRM270220L	220VDC+LED/5,2mA	10 A / 250 V AC, 2 CO	7760056063	58,25 TL	20
DRM270524L	24VAC+LED/62,4mA @50Hz	10 A / 250 V AC, 2 CO	7760056064	45,10 TL	20
DRM270548L	48VAC+LED/33,3mA @50Hz	10 A / 250 V AC, 2 CO	7760056065	44,10 TL	20
DRM270615L	115VAC+LED/12,6mA @50Hz	10 A / 250 V AC, 2 CO	7760056066	44,10 TL	20
DRM270730L	230VAC+LED/6,1mA @50Hz	10 A / 250 V AC, 2 CO	7760056067	46,75 TL	20

4 CO Kontak, 5 A / 250 V AC

DRM570012	12VDC/75mA	5 A / 250 V AC, 4 CO	7760056078	42,35 TL	20
DRM570024	24VDC/36,8mA	5 A / 250 V AC, 4 CO	7760056079	42,35 TL	20
DRM570048	48VDC/18,5mA	5 A / 250 V AC, 4 CO	7760056080	42,55 TL	20
DRM570110	110VDC/10mA	5 A / 250 V AC, 4 CO	7760056081	46,15 TL	20
DRM570220	220VDC/5,2mA	5 A / 250 V AC, 4 CO	7760056082	58,25 TL	20
DRM570524	24VAC/62,4mA @50Hz	5 A / 250 V AC, 4 CO	7760056083	43,50 TL	20
DRM570548	48VAC/33,3mA @50Hz	5 A / 250 V AC, 4 CO	7760056084	42,55 TL	20
DRM570615	115VAC/12,6mA @50Hz	5 A / 250 V AC, 4 CO	7760056085	43,50 TL	20
DRM570730	230VAC/6,1mA @50Hz	5 A / 250 V AC, 4 CO	7760056086	47,40 TL	20
DRM570012L	12VDC +LED/75mA	5 A / 250 V AC, 4 CO	7760056087	45,10 TL	20
DRM570024L	24VDC+LED/36,8mA	5 A / 250 V AC, 4 CO	7760056088	45,10 TL	20
DRM570048L	48VDC+LED/18,5mA	5 A / 250 V AC, 4 CO	7760056089	45,70 TL	20
DRM570110L	110VDC+LED/10mA	5 A / 250 V AC, 4 CO	7760056090	49,35 TL	20
DRM570220L	220VDC+LED/5,2mA	5 A / 250 V AC, 4 CO	7760056091	63,90 TL	20
DRM570524L	24VAC+LED/62,4mA @50Hz	5 A / 250 V AC, 4 CO	7760056092	47,30 TL	20
DRM570548L	48VAC+LED/33,3mA @50Hz	5 A / 250 V AC, 4 CO	7760056093	46,25 TL	20
DRM570615L	115VAC+LED/12,6mA @50Hz	5 A / 250 V AC, 4 CO	7760056094	48,55 TL	20
DRM570730L	230VAC+LED/6,1mA @50Hz	5 A / 250 V AC, 4 CO	7760056095	55,05 TL	20

• Yüksek anahtarlama gücüne sahip kompakt yapı. • Geniş bobin giriş voltaj aralığı. • Opsiyonel test butonu (AC kırmızı, DC mavi). • Opsiyonel durum LEDi (AC kırmızı, DC yeşil). • Opsiyonel diyot koruması

LED'li ve Test Butonlu 4 CO Kontak, 5A / 250 VAC

DRM570012LT	12VDC/75mA	5 A / 250 V AC, 4 CO	7760056096	45,70 TL	20
DRM570024LT	24VDC/36,8mA	5 A / 250 V AC, 4 CO	7760056097	46,75 TL	20



FS 2CO

Tip	Giriş	Çıkış	Sipariş No	Fiyat/Birim	Ambalaj
DRM570524LT	24VAC/62,4mA @50Hz	5 A / 250 V AC, 4 CO	7760056101	49,60 TL	20
DRM570048LT	48VDC/18,5mA	5 A / 250 V AC, 4 CO	7760056098	49,25 TL	20
DRM570548LT	48VAC/33,3mA @50Hz	5 A / 250 V AC, 4 CO	7760056102	49,60 TL	20
DRM570110LT	110VDC/10mA	5 A / 250 V AC, 4 CO	7760056099	52,00 TL	20
DRM570615LT	115VAC/12,6mA @50Hz	5 A / 250 V AC, 4 CO	7760056103	50,90 TL	20
DRM570220LT	220VDC/5,2mA	5 A / 250 V AC, 4 CO	7760056100	66,00 TL	20
DRM570730LT	230VAC/6,1mA @50Hz	5 A / 250 V AC, 4 CO	7760056104	52,30 TL	20

DRM Tip Röle Soket ve Klipsleri

FS 2CO	2 kontak röle soketi		7760056106	24,00 TL	10
FS 4CO	4 kontak röle soketi		7760056107	30,25 TL	10
DRM/DRL CLIP M	Metal Klip		7760056108	1,22 TL	10
SCM 2CO P	2 kontak röle soketi Push-in		7760056362	77,65 TL	10
SCM 4CO P	4 kontak röle soketi Push-in		7760056363	88,20 TL	10

DRM Tip Röle LED ve Koruma Modülleri

RIM 1 6/230VDC	Diyot Koruması 6...230 V DC		7760056169	7,88 TL	10
RIM 3 110/230VAC	RC filtre koruması 110...230 V AC		7760056014	24,00 TL	10
RIM 3 110/230VAC LED	RC filtre koruması 110...230 VAC LED ile birlikte		7760056045	24,00 TL	10
RIM 2 6/24VDC	Yeşil LED 6...24 V DC diyot korumalı		7760056015	15,40 TL	10
RIM 2 24/60VDC	Yeşil LED 24...60 V DC diyot korumalı		7760056016	15,40 TL	10
RIM 2 110/230VDC	Yeşil LED 110...230 V DC diyot korumalı		7760056017	15,05 TL	10
RIM 3 6/24VUC	Yeşil LED 6...24 V DC / V AC		7940018457	15,40 TL	20
RIM 3 24/60VUC	Yeşil LED 24...60 V DC / V AC		7760056018	15,05 TL	10
RIM 3 110/230VUC	Yeşil LED 110...230 V DC / V AC		7940018455	15,80 TL	20

DRL Güç Röleleri**1 CO Kontak, 16 A / 250 V AC**

DRL170012L	12VDC/75mA	16 A/250VAC, 1CO	1133450000	112,70 TL	20
DRL170024L	24VDC/36,8mA	16 A/250VAC, 1CO	1133460000	112,70 TL	20
DRL170048L	48VDC/18,5mA	16 A/250VAC, 1CO	1133470000	123,35 TL	20
DRL170110L	110VDC/10mA	16 A/250VAC, 1CO	1133480000	135,20 TL	20
DRL170220L	220VDC/5,2mA	16 A/250VAC, 1CO	1133490000	135,20 TL	20
DRL170524L	24VAC/54mA	16 A/250VAC, 1CO	1133840000	123,35 TL	20
DRL170615L	115VAC/12,9mA	16 A/250VAC, 1CO	1133850000	135,20 TL	20
DRL170730L	230VAC/6,8mA	16 A/250VAC, 1CO	1133860000	135,20 TL	20

2 CO Kontak, 10 A / 250 V AC

DRL270012L	12VDC/75mA	10 A/250VAC, 2CO	1133510000	135,20 TL	20
DRL270024L	24VDC/36,8mA	10 A/250VAC, 2CO	1133520000	135,20 TL	20
DRL270048L	48VDC/18,5mA	10 A/250VAC, 2CO	1133530000	146,50 TL	20
DRL270110L	110VDC/10mA	10 A/250VAC, 2CO	1133540000	157,80 TL	20
DRL270220L	220VDC/5,2mA	10 A/250VAC, 2CO	1133550000	157,15 TL	20
DRL270524L	24VAC/54mA	10 A/250VAC, 2CO	1133870000	146,50 TL	20
DRL270615L	115VAC/12,9mA	10 A/250VAC, 2CO	1133880000	157,15 TL	20
DRL270730L	230VAC/6,8mA	10 A/250VAC, 2CO	1133890000	157,15 TL	20

3 CO Kontak, 10 A / 250 V AC

DRL370012L	12VDC/120mA	10 A/250VAC, 3CO	1133570000	168,40 TL	10
DRL370024L	24VDC/60mA	10 A/250VAC, 3CO	1133580000	172,30 TL	10
DRL370048L	48VDC/30mA	10 A/250VAC, 3CO	1133590000	191,00 TL	10
DRL370110L	110VDC/13,1mA	10 A/250VAC, 3CO	1133600000	202,15 TL	10
DRL370220L	220VDC/6,7mA	10 A/250VAC, 3CO	1133610000	202,15 TL	10
DRL370524L	24VAC/80mA	10 A/250VAC, 3CO	1133910000	191,00 TL	10
DRL370615L	115VAC/16mA	10 A/250VAC, 3CO	1133920000	202,15 TL	10
DRL370730L	230VAC/10mA	10 A/250VAC, 3CO	1133930000	202,15 TL	10



DRL170012L



DRL370012L



DRL570012L



SLD F 2CO



DRR270012L



DRR370012L



SRD ECO 2CO



TRS 24VDC 1CO

Tip	Giriş	Çıkış	Sipariş No	Fiyat/Birim	Ambalaj
4 CO Kontak, 10 A / 250 V AC					
DRL570012L	12VDC/125mA	10 A/250VAC, 4CO	1133620000	224,15 TL	10
DRL570024L	24VDC/66,7mA	10 A/250VAC, 4CO	1133630000	224,15 TL	10
DRL570048L	48VDC/31,2mA	10 A/250VAC, 4CO	1133640000	247,20 TL	10
DRL570110L	110VDC/16,2mA	10 A/250VAC, 4CO	1133650000	269,30 TL	10
DRL570220L	220VDC/7,6mA	10 A/250VAC, 4CO	1133660000	269,30 TL	10
DRL570524L	24VAC/93,7mA	10 A/250VAC, 4CO	1133940000	247,20 TL	10
DRL570615L	115VAC/25,5mA	10 A/250VAC, 4CO	1133950000	269,30 TL	10
DRL570730L	230VAC/13,1mA	10 A/250VAC, 4CO	1133960000	269,30 TL	10

DRL Tip Rölelerin Soket ve Klipsleri					
SLD F 2CO	2 kontak vidalı tip röle soketi		7760056225	77,70 TL	10
SLD F 3CO	3 kontak vidalı tip röle soketi		7760056226	97,95 TL	10
SLD F 4CO	4 kontak vidalı tip röle soketi		7760056227	113,70 TL	10
DRM/DRL CLIP M	Metal Klips		7760056108	1,22 TL	10
SLD CLIP 3CO M	3 kontak soket Klips		7760056234	7,50 TL	10
SLD CLIP 4CO M	4 kontak soket Klips		7760056235	7,50 TL	10

DRL Tip Röle Koruma Modülü					
RIM 1 6/230VDC	Diyot Koruması 6...230 V DC		7760056169	7,88 TL	10
RIM 3 110/230VAC	RC filtre koruması 110...230 V AC		7760056014	24,00 TL	10
RIM 5 6/230VAC	4 kontak soket için RC filtre		1174670000	34,40 TL	10
RIM 5 6/230VDC	4 kontak soket için diyot		1174650000	35,15 TL	10

DRR Güç Röleleri					
2 CO Kontak, 10 A / 250 V AC					
DRR270012L	12VDC/125mA	10 A/250VAC, 2CO	1133360000	91,45 TL	10
DRR270024L	24VDC/55,8mA	10 A/250VAC, 2CO	1133370000	93,55 TL	10
DRR270048L	48VDC/29,3mA	10 A/250VAC, 2CO	1133380000	101,40 TL	10
DRR270110L	110VDC/14,9mA	10 A/250VAC, 2CO	1133390000	112,70 TL	10
DRR270220L	220VDC/7,5mA	10 A/250VAC, 2CO	1133400000	135,20 TL	10
DRR270524L	24VAC/130mA @50Hz	10 A/250VAC, 2CO	1133760000	90,20 TL	10
DRR270615L	115VAC/29,8mA @50Hz	10 A/250VAC, 2CO	1133780000	101,40 TL	10
DRR270730L	230VAC/14,9mA @50Hz	10 A/250VAC, 2CO	1133800000	101,40 TL	10

3 CO Kontak, 10 A / 250 V AC					
DRR370012L	12VDC/125mA	10 A/250VAC, 3CO	1133410000	103,75 TL	10
DRR370024L	24VDC/55,8mA	10 A/250VAC, 3CO	1133420000	103,75 TL	10
DRR370048L	48VDC/29,3mA	10 A/250VAC, 3CO	1133430000	112,70 TL	10
DRR370110L	110VDC/14,9mA	10 A/250VAC, 3CO	1133440000	129,55 TL	10
DRR370220L	220VDC/7,5mA	10 A/250VAC, 3CO	1133560000	146,50 TL	10
DRR370524L	24VAC/130mA @50Hz	10 A/250VAC, 3CO	1133810000	115,25 TL	10
DRR370615L	115VAC/29,8mA @50Hz	10 A/250VAC, 3CO	1133820000	129,55 TL	10
DRR370730L	230VAC/14,9mA @50Hz	10 A/250VAC, 3CO	1133830000	126,20 TL	10

DRR Tip Rölelerin Soket ve Aksesuarları					
SRD ECO 2CO	2 kontak röle soketi		1132810000	36,10 TL	10
SRD ECO 3CO	3 kontak röle sokeri		1132820000	36,10 TL	10
DRR CLIP M	Metal Klips		1134160000	5,64 TL	10
RIM 5 6/230VAC	4 kontak soket için RC filtre		1174670000	34,40 TL	10
RIM 5 6/230VDC	4 kontak soket için diyot		1174650000	35,15 TL	10

Term Serisi Röleler					
1 CO Kontak 6A, 6,4 mm genişlik					
TRS 24VDC 1CO	24 VDC	250V / 6A, 1CO	1122770000	85,65 TL	10
TRS 24VUC 1CO	24V AC/DC	250V / 6A, 1CO	1122780000	120,60 TL	10
TRS 120VUC 1CO	120V AC/DC	250V / 6A, 1CO	1122810000	169,55 TL	10

Serinin devamı sayfa 107

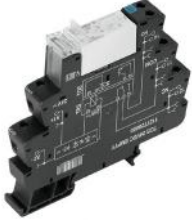

TRS 5VDC 1CO 16A



TRS 24VDC 1NO HC



TRS 24VDC 2CO

Tip	Giriş	Çıkış	Sipariş No	Fiyat/Birim	Ambalaj
TRS 230VUC 1CO	230V AC/DC	250V / 6A, 1CO	1122820000	169,55 TL	10
TRS 120VAC RC 1CO	120V AC	250V / 6A, 1CO	1122830000	202,15 TL	10
TRS 230VAC RC 1CO	230V AC	250V / 6A, 1CO	1122840000	212,25 TL	10
TRS 24-230VUC 1CO	24 V.....230 VAC/dc üniversal giriş	250V / 6A, 1CO	1122850000	275,20 TL	10
1 CO Kontak 16A, 12,8 mm genişlik					
TRS 5VDC 1CO 16A	5V DC	250V / 16A, 1CO	1479650000	151,45 TL	10
TRS 12VDC 1CO 16A	12V DC	250V / 16A, 1CO	1479670000	152,75 TL	10
TRS 24VDC 1CO 16A	24V DC	250V / 16A, 1CO	1479680000	157,05 TL	10
TRS 24VUC 1CO 16A	24V AC/DC	250V / 16A, 1CO	1479690000	174,00 TL	10
TRS 48VUC 1CO 16A	48V AC/DC	250V / 16A, 1CO	1479700000	178,00 TL	10
TRS 60VUC 1CO 16A	60V AC/DC	250V / 16A, 1CO	1479710000	177,05 TL	10
TRS 120VUC 1CO 16A	120V AC/DC	250V / 16A, 1CO	1479730000	184,60 TL	10
TRS 230VUC 1CO 16A	230V AC/DC	250V / 16A, 1CO	1479740000	184,60 TL	10
TRS 120VAC RC 1CO 16A	120V AC	250V / 16A, 1CO	1479750000	226,60 TL	10
TRS 230VAC RC 1CO 16A	230V AC	250V / 16A, 1CO	1479760000	221,65 TL	10
TRS 24-230VUC 1CO 16A	24 V.....230 VAC/dc üniversal giriş	250V / 16A, 1CO	1479770000	286,50 TL	10
1 NO Kontak 16A, 12,8 mm genişlik, Inrush Power HC (Inductive Yük Uygulamaları)					
TRS 24VDC 1NO HC	24V DC	250V / 16A, 1NO	1479780000	180,70 TL	10
TRS 24-230VUC 1NO HC	24 V.....230 VAC/dc üniversal giriş	250V / 16A, 1NO	1479790000	311,60 TL	10
1 NO Kontak 16A, 12,8 mm genişlik, Inrush Power HCp (Capacitive Yük Uygulamaları)					
TRS 24VDC 1NO HCP	24V DC	250V / 16A, 1NO	1479810000	205,30 TL	10
TRS 24-230VUC 1NO HCP	24 V.....230 VAC/dc üniversal giriş	250V / 16A, 1NO	1479830000	329,20 TL	10
2 CO Kontak, 12,8 mm genişlik					
TRS 24VDC 2CO	24 Vdc	250V / 2 X 8A, 2CO	1123490000	140,25 TL	10
TRS 24VUC 2CO	24 Vac/dc	250V / 2 X 8A, 2CO	1123500000	160,00 TL	10
TRS 120VUC 2CO	120 Vac/dc	250V / 2 X 8A, 2CO	1123530000	167,75 TL	10
TRS 230VUC 2CO	230 Vac/dc	250V / 2 X 8A, 2CO	1123540000	176,15 TL	10
TRS 120VAC RC 2CO	120 Vac	250V / 2 X 8A, 2CO	1123550000	207,20 TL	10
TRS 230VAC RC 2CO	230 Vac	250V / 2 X 8A, 2CO	1123570000	217,55 TL	10
TRS 24-230VUC 2CO	24 V.....230 Vac/dc üniversal giriş	250V / 2 X 8A, 2CO	1123580000	274,10 TL	10
Yaylı 1 CO Kontak 6A, 6,4 mm genişlik					
TRZ 24VDC 1CO	24 VDC	250V / 6A, 1CO	1122880000	88,00 TL	10
TRZ 24VUC 1CO	24V AC/DC	250V / 6A, 1CO	1122890000	128,75 TL	10
TRZ 120VUC 1CO	120V AC/DC	250V / 6A, 1CO	1122920000	161,45 TL	10
TRZ 230VUC 1CO	230V AC/DC	250V / 6A, 1CO	1122930000	169,55 TL	10
TRZ 120VAC RC 1CO	120V AC	250V / 6A, 1CO	1122940000	202,15 TL	10
TRZ 230VAC RC 1CO	230V AC	250V / 6A, 1CO	1122950000	212,25 TL	10
TRZ 24-230VUC 1CO	24 V.....230 VAC/dc üniversal giriş	250V / 6A, 1CO	1122970000	262,90 TL	10
PUSH-IN 1 CO Kontak 6A, 6,4 mm genişlik					
* TRP 24VDC 1CO	24 VDC	250V / 6A, 1CO	2618000000	93,50 TL	10
* TRP 24VUC 1CO	24V AC/DC	250V / 6A, 1CO	2618220000	122,65 TL	10
* TRP 120VUC 1CO	120V AC/DC	250V / 6A, 1CO	2618010000	169,55 TL	10
* TRP 230VUC 1CO	230V AC/DC	250V / 6A, 1CO	2618050000	169,55 TL	10
* TRP 120VAC RC 1CO	120V AC	250V / 6A, 1CO	2618150000	212,25 TL	10
* TRP 230VAC RC 1CO	230V AC	250V / 6A, 1CO	2618200000	212,25 TL	10
Term Serisi Röleler için Üst Köprüler					
* TCC 6.4/10 OR	10 Kutuplu, Turuncu, 1 Kontak için		2556360000	33,00 TL	10
* TCC 6.4/51 OR	51 Kutuplu, Turuncu, 1 Kontak için		2556370000	165,00 TL	10
* TCC 6.4/10 BL	10 Kutuplu, Mavi, 1 Kontak için		2556440000	33,00 TL	10
* TCC 6.4/51 BL	51 Kutuplu, Mavi, 1 Kontak için		2556450000	165,00 TL	10
* TCC 6.4/10 RD	10 Kutuplu, Kırmızı, 1 Kontak için		2556400000	33,00 TL	10

Serinin devamı sayfa 108

Röleler ve Optokuplörler



TIA SUBD 15S



TIAL F20



TXS SUPPLY



MCZ R 24VDC



RSM 8RS 24VDC LP GEM-



TRP T 24VDC 1CO M3



TIMER BTM-S

Tip	Giriş	Çıkış	Sipariş No	Fiyat/Birim	Ambalaj
* TCC 6.4/51 RD	51 Kutuplu, Kırmızı, 1 Kontak için		2556410000	165,00 TL	10
* TCC 12.8/26 BL	26 Kutuplu, Mavi, 2 Kontak için		2556460000	160,15 TL	10
* TCC 12.8/26 RD	26 Kutuplu, Kırmızı, 2 Kontak için		2556420000	160,15 TL	10

Term Serisi Röle Aksesuarları

TIA SUBD 15S	8 Adet TRS Röle İçin 15 Kutup SUB-D bağlantı tipi PLC Adaptörü		1463530000	700,00 TL	1
TIAL F10	8 Adet TRS Röle İçin 10 Kutuplu PLC arayüz bağlantısı- Adaptörü		1463540000	659,00 TL	1
TIAL F20	16 Adet TRS Röle İçin 20 Kutuplu PLC arayüz bağlantısı- Adaptörü		1463550000	847,00 TL	1
TXS SUPPLY	Besleme Terminali		1240780000	91,45 TL	10
TW TXS/TXZ R3.2	İzolasyon plakası		1240800000	10,85 TL	10
WEW 35/2 SW	Vidalı Tip Siyah Durdurucu		1061210000	25,30 TL	100
WS 10/6 MC NE WS			1828450000	1,06 TL	600

Not: 1 ve 2 enversör kontaklar Vidalı ve yaylı bağlantı 6.4 ve 12.8 mm röle genişliği ZQV ile köprülenebilir. Universal giriş 24...230 V AC/DC

MCZ Serisi Röleler

1 Enversör Kontak

MCZ R 24VDC	24 Vdc / 6,3 mA	250 V / 6 A, 1CO	8365980000	170,90 TL	10
MCZ R 24VUC	24 Vac/dc / 10,8 mA	250 V / 6 A, 1CO	8390590000	298,60 TL	10
MCZ R 120VAC	120 Vac/dc / 7 mA	250 V / 6 A, 1CO	8420880000	373,00 TL	10
MCZ R 230VAC	230 Vac / 9,5 mA	250 V / 6 A, 1CO	8237710000	391,85 TL	10

MCZ Röle İçin Nihayet Plakası

AP MCZ1.5	MCZ Nihayet Plakası		8389030000	17,50 TL	50
-----------	---------------------	--	------------	----------	----

Not: 1 Enversör Kontak 250 VAC/6A ,6mm Röle Genişliği ,ZQV ile Köprülenebilir, Yeşil LED

MCZ Serisi Röleler için Üst Köprüler

ZQV 4N/10 GE	10'lu Sarı		1758260000	45,60 TL	20
ZQV 4N/10 RT	10'lu Kırmızı		1794040000	45,10 TL	20
ZQV 4N/10 BL	10'lu Mavi		1794050000	45,10 TL	20
ZQV 4N/41	41'li Sarı		1758270000	185,30 TL	10
ZQV 4N/41 RT	41'li Kırmızı		1794070000	185,30 TL	10
ZQV 4N/41 BL	41'li Mavi		1794080000	185,30 TL	10

Çoklu Röle Modülü

RSM 8RS 24VDC LP GEM-	24 Vdc / 23 mA	250 V / 6 A, 1CO	1113561001	120,00 €	1
-----------------------	----------------	------------------	------------	----------	---

Tip	Açıklama	Sipariş No	Fiyat/Birim	Ambalaj
-----	----------	------------	-------------	---------

Term Serisi Slim Zaman Röleleri

* TRS T 24VDC 1CO M3	Vidalı , 1 CO Kontak 6A, Çekmede gecikme, Flaşör, Tetiklemeli	2639560000	444,55 TL	10
* TRP T 24VDC 1CO M3	PUSHN, 1 CO Kontak 6A, Çekmede gecikme, Flaşör, Tetiklemeli	2639730000	Sorunuz	Sorunuz

TFI Serisi Zaman Röleleri

* TFI 12-240VUC 1CO M7C	7 Fonksiyonlu Zaman Rölesi 0.05 s - 100 saat arası ayarlanabilir, Multi-Fonksiyon, 12 - 240 V AC/DC	2697250000	585,00 TL	1
* TFI 12-240VUC 2NO SD	Yıldız Üçgen Röle 2 NO Kontak, 12 - 240 V AC/DC	2697270000	698,00 TL	1
* TFI 24-240VUC 1CO ON	Çekme gecikmeli, 1 CO Kontak, 12 - 240 V AC/DC	2697280000	531,00 TL	1
* TFI 24-240VUC 1CO OFFC	Bırakma gecikmeli, 1 CO Kontak, 12 - 240 V AC/DC	2697290000	531,00 TL	1

Zaman Röleleri

TIMER BTM-S	8 farklı Fonksiyon, 0,1 sn-120 Saat, 5A/250Vac	8647700000	95,00 €	10
TIMER BTMF-S	4 farklı Fonksiyon, 0,1 sn-120 Saat, 5A/250Vac	8647680000	64,35 €	10
TIMER BTR-S	Çekmede Gecikme, 0,1 sn-120 Saat, 5A/250Vac	8647720000	80,00 €	1
TIMER BTMT-S	İkiz Zamanlı, 0,1 sn-120 saat, 5A/250Vac	8647740000	130,00 €	10
ITS 24-240VUC 1CO M7C	7 farklı Fonksiyon (bağımsız kontrol birimleri), Multi-Voltaj: 24-48 VDC, 24-240 VAC	2496190000	42,00 €	1
BT LOCK PEN	Zaman Röleleri İçin Özel Ayar Kalemli	8659840000	22,95 €	5



TOP 5VDC/48VDC 0,1A



ZQV 4N/10 GE



TOS 24-230VUC 48VDC0,1A



TOS 24VUC 230VAC1A

Tip	Giriş	Çıkış	Sipariş No	Fiyat/Birim	Ambalaj
Termopto Serisi Optokuplörler					
100 mA DC Çıkış					
TOP 5VDC/48VDC 0,1A	5 Vdc	5...48 Vdc / 0,1 A	8950760000	132,50 TL	10
TOP 24VDC/48VDC 0,1A	24 Vdc	5...48 Vdc / 0,1 A	8950780000	132,50 TL	10
TOP 24VAC/48VDC 0,1A	24 Vac	5...48 Vdc / 0,1 A	8950860000	137,70 TL	10
TOP 120VAC/48VDC 0,1A	120 Vac	5...48 Vdc / 0,1 A	8950880000	150,85 TL	10
TOP 230VAC/48VDC 0,1A	230 Vac	5...48 Vdc / 0,1 A	8950890000	165,15 TL	10
500 mA DC Çıkış					
TOP 5VDC/48VDC 0,5A	5 Vdc	5...48 Vdc / 0,5 A	8950960000	165,80 TL	10
TOP 24VDC/48VDC 0,5A	24 Vdc	5...48 Vdc / 0,5 A	8950980000	165,80 TL	10
TOP 24VAC/48VDC 0,5A	24 Vac	5...48 Vdc / 0,5 A	8951060000	170,90 TL	10
TOP 120VAC/48VDC 0,5A	120 Vac	5...48 Vdc / 0,5 A	8951080000	182,75 TL	10
TOP 230VAC/48VDC 0,5A	230 Vac	5...48 Vdc / 0,5 A	8951090000	193,40 TL	10
100 mA AC Çıkış					
TOP 5VDC/230VAC 0,1A	5 Vdc	24...230 Vac / 0,1 A	8951160000	254,10 TL	10
TOP 24VDC/230VAC 0,1A	24 Vdc	24...230 Vac / 0,1 A	8951180000	254,10 TL	10
TOP 24VAC/230VAC 0,1A	24 Vac	24...230 Vac / 0,1 A	8951260000	262,25 TL	10
TOP 120VAC/230VAC 0,1A	120 Vac	24...230 Vac / 0,1 A	8951280000	274,25 TL	10
TOP 230VAC/230VAC 0,1A	230 Vac	24...230 Vac / 0,1 A	8951290000	285,40 TL	10
4 A DC Çıkış					
TOS 24VDC/24VDC 4A	24 Vdc	3...33Vdc / 4 A	1275100000	229,30 TL	10
Termopto Serisi Optokuplörler İçin Üst Köprüler					
ZQV 4N/10 GE	10'lu Sarı		1758260000	45,60 TL	20
ZQV 4N/10 RT	10'lu Kırmızı		1794040000	45,10 TL	20
ZQV 4N/10 BL	10'lu Mavi		1794050000	45,10 TL	20
ZQV 4N/41	41'li Sarı		1758270000	185,30 TL	10
ZQV 4N/41 RT	41'li Kırmızı		1794070000	185,30 TL	10
ZQV 4N/41 BL	41'li Mavi		1794080000	185,30 TL	10
Not: Push In bağlantı teknolojisi ile Termopto Serisi Optokuplörler elektromekanik rölelere alternatiftir.					
Term Serisi Solid-State Röleler					
100 mA DC Çıkış, 6,4 mm genişlik					
TOS 24-230VUC 48VDC0,1A	24 V....230 Vac/dc universal giriş	0...48 Vdc / 100 mA	1127020000	340,70 TL	10
TOS 24VDC 48VDC0,1A	24 Vdc	0...48 Vdc / 100 mA	1126940000	188,00 TL	10
TOS 24VUC 48VDC0,1A	24 Vac/dc	0...48 Vdc / 100 mA	1126950000	199,00 TL	10
TOS 120VUC 48VDC0,1A	120 Vac/dc	0...48 Vdc / 100 mA	1126980000	235,00 TL	10
TOS 230VUC 48VDC0,1A	230 Vac/dc	0...48 Vdc / 100 mA	1126990000	232,25 TL	10
TOS 120VAC RC 48VDC0,1A	120 Vac	0...48 Vdc / 100 mA	1127000000	272,90 TL	10
TOS 230VAC RC 48VDC0,1A	230 Vac	0...48 Vdc / 100 mA	1127010000	272,90 TL	10
2 A DC Çıkış, 6,4 mm genişlik					
TOS 24-230VUC 24VDC2A	24 V....230 Vac/dc universal giriş	0...24 Vdc / 2A	1127250000	418,80 TL	10
TOS 24VDC 24VDC2A	24 Vdc	0...24 Vdc / 2A	1127170000	197,15 TL	10
TOS 24VUC 24VDC2A	24 Vac/dc	0...24 Vdc / 2A	1127180000	275,45 TL	10
TOS 120VUC 24VDC2A	120 Vac/dc	0...24 Vdc / 2A	1127210000	303,00 TL	10
TOS 230VUC 24VDC2A	230 Vac/dc	0...24 Vdc / 2A	1127220000	303,00 TL	10
TOS 120VAC RC 24VDC2A	120 Vac	0...24 Vdc / 2A	1127230000	342,95 TL	10
TOS 230VAC RC 24VDC2A	230 Vac	0...24 Vdc / 2A	1127240000	350,85 TL	10
1 A AC Çıkış, 6,4 mm genişlik					
TOS 24-230VUC 230VAC1A	24 V....230 Vac/dc universal giriş	24...240 Vac / 1A	1127500000	418,80 TL	10
TOS 24VDC 230VAC1A	24V DC	24...240 Vac / 1A	1127410000	268,15 TL	10
TOS 24VUC 230VAC1A	24V AC/DC	24...240 Vac / 1A	1127420000	282,40 TL	10
TOS 120VUC 230VAC1A	120V AC/DC	24...240 Vac / 1A	1127450000	303,00 TL	10

Serinin devamı sayfa 110



TXS SUPPLY



ZQV 4N/10 GE



MOS 24VDC/5-33VDC 10A

Tip	Giriş	Çıkış	Sipariş No	Fiyat/Birim	Ambalaj
TOS 230VUC 230VAC1A	230V AC/DC	24...240 Vac / 1A	1127470000	309,95 TL	10
TOS 120VAC RC 230VAC1A	120V AC	24...240 Vac / 1A	1127480000	342,95 TL	10
TOS 230VAC RC 230VAC1A	230V AC	24...240 Vac / 1A	1127490000	350,85 TL	10
3,5 A DC Çıkış, 12,8 mm genişlik					
TOS 24-230VUC 24VDC3,5A	24 V.....230 VAC/DC üniversal giriş	0...33 Vdc / 3,5A	1127640000	502,00 TL	10
TOS 24VDC 24VDC3,5A	24V DC	0...33 Vdc / 3,5A	1127630000	311,80 TL	10
1 A AC Çıkış, 12,8 mm genişlik					
TOS 24-230VUC 230VAC1A	24 V.....230 VAC/DC üniversal giriş	12...275 Vac / 1A	1127690000	489,25 TL	10
TOS 24VDC 230VAC1A	24V DC	12...275 Vac / 1A	1127680000	311,80 TL	10
5 A DC Çıkış, 12,8 mm genişlik					
TOS 24VDC 24VDC5A	24V DC	3...33V DC 5A	1990960000	355,35 TL	10
TOS 24-230VUC 24VDC5A	24 V.....230 VAC/DC üniversal giriş	3...33V DC 5A	1990970000	740,00 TL	10
Term Serisi Solid - State Aksesuarları					
TXS SUPPLY	Besleme Terminali		1240780000	91,45 TL	10
TW TXS/TXZ R3.2	İzolasyon plakası		1240800000	10,85 TL	10
WEW 35/2 SW	Vidalı Tip Siyah Durdurucu		1061210000	25,30 TL	100
WS 10/6 MC NE WS	Markalama		1828450000	1,06 TL	600
Not: 100 mA'den 5 A'e kadar ,Vidalı ve yaylı bağlantı, 6.4 mm ve 12.8 mm röle genişliği, Üniversal giriş 24...230 Vac/dc					
Term Serisi Solid-State Röleler için Üst Köprüler					
Term Serisi Röleler için Üst Köprüler					
* TCC 6.4/10 OR	10 Kutuplu, Turuncu, 1 Kontak için		2556360000	33,00 TL	10
* TCC 6.4/51 OR	51 Kutuplu, Turuncu, 1 Kontak için		2556370000	165,00 TL	10
Term Serisi Röleler					
Term Serisi Röleler için Üst Köprüler					
* TCC 12.8/26 OR	26 Kutuplu, Turuncu, 2 Kontak için		2556380000	160,15 TL	10
Micro Serisi Optokuplörler için Üst Köprüler					
ZQV 4N/10 GE	10'lu Sarı		1758260000	45,60 TL	20
ZQV 4N/10 RT	10'lu Kırmızı		1794040000	45,10 TL	20
ZQV 4N/10 BL	10'lu Mavi		1794050000	45,10 TL	20
ZQV 4N/41	41'li Sarı		1758270000	185,30 TL	10
ZQV 4N/41 RT	41'li Kırmızı		1794070000	185,30 TL	10
ZQV 4N/41 BL	41'li Mavi		1794080000	185,30 TL	10
Özel Uygulamalar için Micro Opto Serisi Optokuplörler					
10 A Selenoid Sürücü					
MOS 24VDC/5-33VDC 10A	24 Vdc	5...33 Vdc / 10 A	8937940000	500,00 TL	1
Direkt Aktüatör Bağlantısı için					
MOS 24VDC/8-30VDC 2A	24 Vdc	8...30 Vdc / 2 A	8937970000	535,00 TL	1
300 VDC'ye Kadar İndüktif Yükler için					
MOS 24VDC/12-300VDC 1A	24 Vdc	12...300 Vdc / 1 A	8937830000	505,00 TL	1
1 kHz Elektronik Anahtarlama					
MOS 24VDC/5-48VDC 0,5A	24 Vdc	5...48 Vdc / 500 mA	8937980000	332,40 TL	1
100 kHz Yüksek Anahtarlama Frekansı					
MOS 12-28VDC 100kHz	12...28 Vdc	24 Vdc / 50 mA	8937990000	390,00 TL	1
100 kHz TTL Sinyalden Dönüştürme					
MOS 5VTTL/24VDC 0,1A	5 V TTL	19.6...28.8 V / 100 mA	8937920000	330,00 TL	1
100 kHz TTL Sinyale Dönüştürme					
MOS 12-28VDC/5VTTL	12...28 Vdc	5 V TTL / 50 mA	8937930000	330,00 TL	1



PSSR 24VDC/1PH AC 25A



SCS 24VDC P1SIL3DS

Tip	Giriş	Çıkış	Sipariş No	Fiyat/Birim	Ambalaj
PSSR Serisi Güç Solid-state Röleleri					
PSSR 24VDC/1PH AC 25A	1 Faz AC, 24VDC, 25A		1406200000	75,00 €	1
PSSR 230VAC/1PH AC 25A	1 Faz AC, 230VAC, 25A		1406220000	67,50 €	1
PSSR 24VDC/1PH AC 35A	1 Faz AC, 24VDC, 35A		1406210000	95,50 €	1
Güvenlik Röleleri (24V DC SIL 3 DN EN 61508)					
SCS 24VDC P1SIL3DS	24 Vdc Güvenlik Kategorisi: SIL3 DIN EN 61508		1303890000	96,50 €	1
SCS 24VDC P1SIL3DS M	24 Vdc Güvenlik Kategorisi: SIL3 DIN EN 61508, İzleme devresi		1303760000	131,00 €	1
SCS 24VDC P1SIL3DS MG3	24 Vdc Güvenlik Kategorisi: SIL3 DIN EN 61508, G3, İzleme devresi		1304040000	163,00 €	1
SCS 24VDC P2SIL3DSES	24 Vdc Güvenlik Kategorisi: SIL3 DIN EN 61508, Test girişi		1319270000	160,00 €	1
SCS 24VDC P2SIL3ES	24 Vdc Güvenlik Kategorisi: SIL3 DIN EN 61508, EN ISO 13849-1 Ple		1319280000	170,00 €	1
SCS 24VDC P1SIL3DS I	24 Vdc Güvenlik Kategorisi: SIL3 DIN EN 61508 (Schneider Triconex® safety PLC için)		2500980000	100,00 €	1

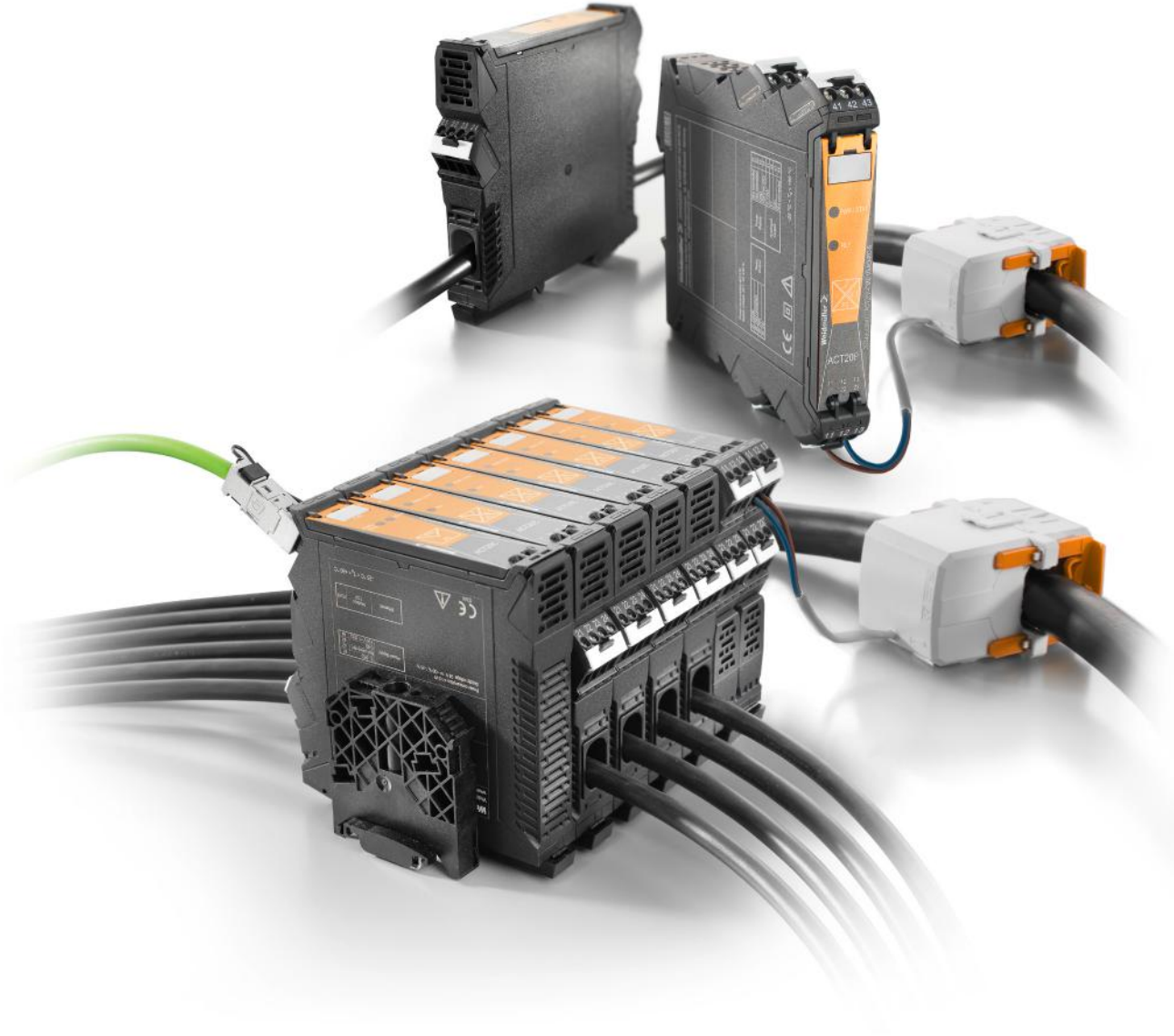

Analog Sinyal Dönüştürücüler

Analog sinyal dönüştürücüler petrol, kimya, enerji, su arıtma, çimento ve demir çelik gibi birçok endüstri ve proses otomasyonunda kullanılmaktadırlar. Üretim prosesinde sıcaklık, basınç, akış miktarı, boş/dolu uygulamaları, ağırlık ve hız gibi parametrelerin ölçülüp denetlenmesi gerektiğinde kullanılırlar. Ölçülen sinyaller, proses zincirinde dış etkilerden etkilenmeden ve uzun mesafelerde gönderilmelidirler. Kararlılık ısı, elektromanyetik dalgalar, titreşim, paslanma gibi etkenlerden etkilenmemelidir. Patlama tehlikesi olan ortamlarda sinyal alışverişi devam etmelidir.

Aşağıdaki özelliklere sahiptirler:

- Sinyallerin galvanik izolasyonu
- Gelen sinyalin başka bir sinyale dönüştürülmesi
- Kuvvetlendirme, lineerleştirme, dönüştürme.
- Düşük sensör sinyallerinin hiçbir kayıp olmadan yukarılara taşınması
- Opsiyonel durum göstergeleri ve alarm kontakları dönüştürme prosesinin takip edilmesini sağlar.

Dönüştürücü ürün gurubu şu dönüştürme ve izolasyon fonksiyonlarını yerine getirebilir:

- DC/DC-Dönüştürme
- Gerilim
- Akım
- Sıcaklık-RTD ve Termokuplör
- Frekans
- Loadcell
- Potansiyometre
- AC-gerilim ve akım izleme
- Alarm (Sınır değeri)
- AD/DA-çeviriciler

Bu ürün grupları, 2-yollu izolasyonlu, 3-yollu izolasyonlu, aktif veya pasif dönüştürücü olarak mevcuttur.



Analog Sinyal Dönüştürücüler



ACT20P-BRIDGE-S



ACT20P-CI-2CO



ACT20P-AI-AO-DC-S



ACT20P-CMT-10-AO-RC-S

Tip	Giriş	Çıkış	Sipariş No	Fiyat/Birim	Ambalaj
ACT20P Serisi Universal Dönüştürücü					
ACT20P Serisi Load Cell Dönüştürücü					
ACT20P-BRIDGE-S	Load Cell	0 - 11V / 0-22mA	1067250000	381,00 €	1
ACT20P Hart Protokol Sinyal Dönüştürücüler					
ACT20P-CI-2CO	0(4)...20 mA 2/3 Kablolü, HART Dijital Sinyal	0(4)...20 mA	7760054115	260,00 €	1
ACT20P-2CI-2CO-12	0(4)...20 mA 2/3 Kablolü, HART Dijital Sinyal	0(4)...20 mA	7760054117	275,00 €	1
ACT20P Serisi Universal Limit Değer İzleme					
ACT20P-UI-2RCO-DC-S*	Thermocouples: B, E, J, K, L, N, R, S, T, U, PT100/2-/3-Kablolu, PT200, PT1000, N120, Cu 10 Potentiometer: 1.2 kΩ - 500 kΩ, Resistance: 0 - 1.5 kΩ / 0 - 12 kΩ / 0 - 750 Ω	2 CO Alarm Çıkışı	7940045760	387,00 €	1
ACT20P-UI-AO-DO-LP-S*	PT100 / 2-/3-/4-wire, PT1000/2-/3-/4-wire, PT200, N120, Thermocouples: B, E, J, K, L, N, R, S, T, U, Potentiometer	4...20 mA, 20...4 mA, Current loop, Loop Powered	1453210000	320,00 €	1
ACT20P-PRO-RTCI-AO-DO-S	Potentiometer: 10 - 150kΩ, Resistance: 0 - 15kΩ,	DO: NPN Transistör, alt ve üst limit alarm fonksiyonu, AO: Akım; 0..5V, 0..10V, ±5V, ±10V, Gerilim; ±20mA, ±10mA, 0..20mA	2448100000	340,00 €	1
Not: *Ürünün programlanabilmesi için 8978580000 kodlu CBX200 USB programlama kablosu gerekmektedir					
ACT20P Serisi Universal DC İzolasyon ve Amplifikasyon Modülü					
ACT20P-AI-AO-DC-S	0...11 V / 0...22 mA	0...11 V / 0...22 mA	1477420000	330,00 €	1
ACT20P-PRO DCDC II-S	±20 mV...±300 V ±0.1mA...± 100 mA	0...±10 V, 0...±20 mA	1481970000	380,00 €	1
ACT20P Serisi DC/DC 3-Yollu İzolasyon					
ACT20P-CI-VO	0(4)...20 mA, 2/3 Kablolü,	0...10 V, 2...10 V,	1540010000	165,00 €	1
ACT20P Serisi DC/DC 2-Yollu İzolasyon, Çıkıştan Beslemeli					
ACT20P-VI-CO-OLP	0...10 V	4...20 mA	7760054121	200,00 €	1
ACT20P-VI1-CO-OLP	0...5 V	4...20 mA	7760054120	158,00 €	100
ACT20P-CI2-CO-OLP	4...20 mA	4...20 mA	7760054119	200,00 €	1
ACT20P Serisi DC/DC 2-Yollu İzolasyon, Çıkıştan Beslemeli, Çoklayıcı					
ACT20P-CI-2CO-OLP	4...20 mA	4...20 mA	7760054122	210,00 €	1
ACT20P Serisi DC/DC 2-Yollu İzolasyon, Girişten Beslemeli					
ACT20P-CI-CO-ILP	0(4)...20 mA	0(4)...20 mA	7760054123	150,00 €	1
ACT20P Serisi DC/DC 2-Yollu İzolasyon, Girişten Beslemeli, Çoklayıcı					
ACT20P-2CI-2CO-ILP	0(4)...20 mA	0(4)...20 mA	7760054124	230,00 €	1
ACT20P Serisi Akım İzleme Modülleri					
ACT20P-CMT-10-AO-RC-S	0...1/5/10 A UC Hall Sensor	0(4)...20 mA, -20...+20 mA 0...10 V, 2...10 V, 0...5 V, 1...5 V, -5...+5 V -10...+10 V, Röle Alarm Çıkışı	1510470000	280,00 €	1
ACT20P-CMT-30-AO-RC-S	0...20/25/30 A Hall Sensor	0(4)...20 mA, -20...+20 mA 0...10 V, 2...10 V, 0...5 V, 1...5 V, -5...+5 V -10...+10 V, Röle Alarm Çıkışı	1510540000	260,00 €	1
ACT20P-CMT-60-AO-RC-S	0...40/50/60 A UC Hall Sensor	0(4)...20 mA, -20...+20 mA 0...10 V, 2...10 V, 0...5 V, 1...5 V, -5...+5 V -10...+10 V, Röle Alarm Çıkışı	1510440000	290,00 €	1
ACT20P-CMT-60-RC-S	0...40/50/60 A UC Hall Sensor	Röle Alarm Çıkışı	1510390000	220,00 €	1

Serinin devamı sayfa 115

Tip	Giriş	Çıkış	Sipariş No	Fiyat/Birim	Ambalaj
ACT20P-CML-10-AO-RC-S	0...1/5/10 A UC	0(4)...20 mA, -20...+20 mA, 0...10 V, 2...10 V, 0...5 V, 1...5 V, -5...+5 V, -10...+10 V, Röle Alarm Çıkışı	2044850000	240,00 €	1



ACT20C-GTW-100-MTCP-S*

ACT20P Serisi Gerilim İzleme Modülleri					
ACT20P-VMR-1PH-H	0-400 V AC/DC, 1 faz izleme, ayarlanabilir 3 kanal opsiyonu	2 CO Röle Çıkışı	7760054164	200,00 €	1
ACT20P-VMR-3PH-IHP-H	180-500 V AC, 3 faz izleme	2 CO Röle Çıkışı	7760054165	220,00 €	1
ACT20P-VM-AO-S*	0-500 V AC, 1 faz izleme, ayarlanabilir 10 kanal opsiyonu	0(4)...20 mA, 0...10 V	7760054306	255,00 €	1

ACT20P Serisi Sıcaklık İzleme Modülleri					
ACT20P-TMR-RTI-S*	PT100 2/3/4 kablolu, PTC: 0-4kΩ	2 CO Röle Çıkışı	7760054305	230,00 €	1

Not: *Ürünün programlanabilmesi için 8978580000 kodlu CBX200 USB programlama kablosu gerekmektedir

ACT20C Ethernet Arabirimli Analog Sinyal Dönüştürücüler

ACT20C-GTW-100-MTCP-S*	Ethernet Gateway Modülü		1510370000	466,00 €	1
SET CH20M BUS 250MM TS 35X7.5	ACT 20C Haberleşme bus terminal seti / 250 mm		1335140000	973,00 TL	1
ACT20C-LBT-10	ACT 20C Bus termination durdurucu aparatı		1510340000	93,20 €	1
ACT20-FEED-IN-BASIC-S	Raydan besleme modülü / 0.5-2.5 A		1282490000	63,00 €	1
ACT20-FEED-IN-PRO-S	Raydan besleme modülü / 4 A		8965500000	209,00 €	1

Not: *Ürünün programlanabilmesi için 8978580000 kodlu CBX200 USB programlama kablosu gerekmektedir

ACT20C Ethernet Arabirimli İzolasyon Modülleri

ACT20C-AI-AO-MTCP*	0...20 mA, 4...20 mA	0...20 mA, 4...20 mA	1334490000	910,00 €	1
--------------------	----------------------	----------------------	------------	----------	---

Not: *Ürünün programlanabilmesi için 8978580000 kodlu CBX200 USB programlama kablosu gerekmektedir

ACT20C Ethernet Arabirimli Akım İzleme Modülleri

ACT20C-CMT-10-AO-RC-S*	0...5/10 A UC	0(4)...20 mA, -20...+20 mA 0...10 V, 2...10 V, 0...5 V, 1...5 V, -5...+5 V -10...+10 V, Röle Alarm Çıkışı	1510240000	272,00 €	1
ACT20C-CML-10-AO-RC-S*	0...5/10 A UC	0(4)...20 mA, -20...+20 mA 0...10 V, 2...10 V, 0...5 V, 1...5 V, -5...+5 V -10...+10 V, Röle Alarm Çıkışı	2044840000	300,00 €	1
ACT20C-CMT-60-AO-RC-S*	0...40/50/60 A UC	0(4)...20 mA, -20...+20 mA 0...10 V, 2...10 V, 0...5 V, 1...5 V, -5...+5 V -10...+10 V, Röle Alarm Çıkışı	1510420000	272,00 €	1

Not: *Ürünün programlanabilmesi için 8978580000 kodlu CBX200 USB programlama kablosu gerekmektedir

ACT20X Serisi

4-20 mA Akım İzolatörü

ACT20X-SAI-HAO-S*	4...20 mA	4...20 mA	8965450000	235,00 €	1
ACT20X-2SAI-2HAO-S*	4...20 mA	4...20 mA	8965460000	380,00 €	1
ACT20X-HAI-SAO-S*	4...20 mA (Sensör Beslemesi: 28 VDC)	4...20 mA	8965430000	240,00 €	1
ACT20X-2HAI-2SAO-S*	4...20 mA (Sensör Beslemesi: 28 VDC)	4...20 mA	8965440000	328,00 €	1

Not: *Ürünün programlanabilmesi için 8978580000 kodlu CBX200 USB programlama kablosu gerekmektedir

ACT20X Çıkıştan Döngü Beslemeli Universal Dönüştürücü

ACT20X-HUI-SAO-LP-S*	RTD, TC, DC (mA, V)	4...20 mA	1318220000	361,00 €	1
----------------------	---------------------	-----------	------------	----------	---

Not: *Ürünün programlanabilmesi için 8978580000 kodlu CBX200 USB programlama kablosu gerekmektedir

Sıcaklık Transmitteri

ACT20X-HTI-SAO-S*	RTD, TC, DC(mA)	0(4)...20 / 20...4 mA	8965470000	370,00 €	1
ACT20X-2HTI-2SAO-S*	RTD, TC, DC(mA)	0(4)...20 / 20...4 mA	8965480000	513,00 €	1

Not: *Ürünün programlanabilmesi için 8978580000 kodlu CBX200 USB programlama kablosu gerekmektedir



ACT20X-SAI-HAO-S*



ACT20X-2HDI-2SDO-RNO-S*



ACT20M-CI-CO-ILP-S



ACT20M-BAI-AO-S

Tip	Giriş	Çıkış	Sipariş No	Fiyat/Birim	Ambalaj
Universal Transmitter					
ACT20X-HUI-5AO-S*	Universal, RTD,TC,DC (mA,mV)	0...23 mA	8965490000	390,00 €	1
Not: *Ürünün programlanabilmesi için 8978580000 kodlu CBX200 USB programlama kablosu gerekmektedir					
Röle Çıkışlı Namur İzolasyon Transmitteri					
ACT20X-HDI-SDO-RNO-S*	Namur 8V DC/ 8 mA / 0...5 kHz	Röle, 1 NC / Alarm	8965340000	165,00 €	1
ACT20X-HDI-SDO-RNC-S*	Namur 8V DC/ 8 mA / 0...5 kHz	Röle, 1 NO / Alarm	8965350000	171,00 €	1
ACT20X-2HDI-2SDO-RNO-S*	Namur 8V DC/ 8 mA / 0...5 kHz	Röle, 1 NC / Alarm	8965370000	240,00 €	1
ACT20X-2HDI-2SDO-RNC-S*	Namur 8V DC/ 8 mA / 0...5 kHz	Röle, 1 NO / Alarm	8965380000	226,00 €	1
Not: *Ürünün programlanabilmesi için 8978580000 kodlu CBX200 USB programlama kablosu gerekmektedir					
NPN Transistör Çıkışlı Namur İzolasyon Transmitteri					
ACT20X-HDI-SDO-S*	Namur 8V DC/ 8 mA / 0...5 kHz	NPN Transistor/Alarm, 1 NC	8965360000	177,00 €	1
ACT20X-2HDI-2SDO-S*	Namur 8V DC/ 8 mA / 0...5 kHz	NPN Transistor/Alarm, 1 NC	8965390000	260,00 €	1
Not: *Ürünün programlanabilmesi için 8978580000 kodlu CBX200 USB programlama kablosu gerekmektedir					
Ateşleme Korunmalı Selenoid Sürücü					
ACT20X-SDI-HDO-L-S*	NPN, PNP / ≤28 V DC	Röle, 1 NC, Selenoid Driver	8965400000	193,00 €	1
ACT20X-2SDI-2HDO-S*	NPN, PNP / ≤28 V DC	Röle, 1 NC, Selenoid Driver	8965420000	280,00 €	1
ACT20X-SDI-HDO-H-S*	NPN, PNP / ≤28 V DC	Röle, 1 NC, Selenoid Driver	8965410000	217,00 €	1
Not: *Ürünün programlanabilmesi için 8978580000 kodlu CBX200 USB programlama kablosu gerekmektedir					
ACT20M Serisi					
DC / DC Pasif Akım İzolatörü					
ACT20M-CI-CO-ILP-S	0(4)...20 mA	0(4)...20 mA	1176070000	180,00 €	1
ACT20M-CI-CO-OLP-S	4...20 mA	4...20 mA	1176040000	210,00 €	1
ACT20M-2CI-2CO-ILP-S	0(4)...20 mA	0(4)...20 mA	1176080000	330,00 €	1
ACT20M-2CI-2CO-OLP-S	4...20 mA	4...20 mA	1176050000	330,00 €	1
DC / DC 3 Yollu Galvanik İzolasyon - Dip switch ile ayarlanabilir					
ACT20M-CI-CO-S	0(4)...20 mA	0(4)...20 mA	1175980000	195,00 €	1
ACT20M-AI-AO-E-S	0(2) - 10 V / 0(1) - 5 V / 0(4) - 20 mA	0(2) - 10V / 0(1) - 5V / 0(4) - 20mA	1176010000	185,00 €	1
ACT20M-AI-AO-S	0(2) - 10 V / 0(1) - 5 V / 0(4) - 20 mA (Sensör Beslemesi: 17 V DC)	0(2) - 10 V / 0(1) - 5 V / 0(4) - 20 mA	1176000000	206,00 €	1
DC / DC 4 Yollu Galvanik İzolasyon - Dip switch ile ayarlanabilir					
ACT20M-BAI-AO-S	-10...+10 mA, -20 mA...+20 mA -5 V...+5 V, -10 V...+10 V	0(2) - 10V / 0(1) - 5V / 0(4) - 20mA ± 10mA, ± 20mA	1375450000	186,00 €	1
Sinyal Çoklayıcı					
ACT20M-CI-2CO-S	0(4)...20 mA	2x 0(4)...20 mA	1175990000	285,00 €	1
ACT20M-AI-2AO-S	0(2) - 10 V / 0(1) - 5 V / 0(4) - 20 mA	2x 0(2) - 10 V / 0(1) - 5 V / 0(4) - 20 mA	1176020000	331,00 €	1
ACT20M-BAI-2AO-S	-10...+10 mA, -20 mA...+20 mA -5 V...+5 V, -10 V...+10 V	2x 0(2) - 10 V / 0(1) - 5 V / 0(4) - 20 mA ± 10mA, ± 20mA	1375470000	300,00 €	1
Analog Sinyal Dönüştürücü - ACT 20 M Serisi PT100					
ACT20M-RTI-AO-S	PT100-200...+850 °C 2/3/4Kablolu	0(2) - 10V / 0(1) - 5V / 0(4) - 20mA	1375510000	170,00 €	1
ACT20M-RTI-AO-E-S	PT100-200...+850 °C 2/3/4Kablolu	0(2) - 10V / 0(1) - 5V / 0(4) - 20mA	1375520000	145,00 €	1
ACT20M-RTCI-CO-OLP-S	PT100-200...+850 °C 2/3/4 Kablolu TC J -100...+1200°C, TC K -200...+1370°C	0(4)...20 mA	1435590000	210,00 €	1
ACT20M-RTI-CO-EOLP-S	PT100-200...+850 °C 2/3/4 Kablolu TC J -100...+1200°C, TC K -200...+1370°C	0(4)...20 mA	1435610000	147,00 €	1
ACT20M-TCI-AO-S	TC J -100...+1200°C, TCK -200...+1370°C	0(2) - 10 V / 0(1) - 5 V / 0(4) - 20 mA	1375480000	185,00 €	1



CBX200 USB



EPAK-2CI-2CO-ILP



PICOPAK-CI-CO-LP-P



MCZ CCC 0-20mA/0-20mA

Tip	Giriş	Çıkış	Sipariş No	Fiyat/Birim	Ambalaj
Universal Dönüştürücü - FDT/DTM yazılımı ile ayarlanabilir					
ACT20M-UI-A0-S*	0...20 mA, 4...20mA 0(2)...10 V, 0(1)...5 V 10 Ω...10 kΩ, Thermocouples	0(4) - 20 mA / 0(2) - 10 V	1176030000	320,00 €	1
Not: *Ürünün programlanabilmesi için 8978580000 kodlu CBX200 USB programlama kablosu gerekmektedir					
Programlama Kablosu					
CBX200 USB	Programlama Kablosu		8978580000	120,00 €	1
E-PAK Serisi					
DC/DC 3-Yollu Galvanik İzolasyon					
EPAK-CI-CO	0(4)...20 mA	0(4)...20 mA	7760054181	92,00 €	1
EPAK-PCI-CO	0(4)...20 mA 2 kablolu sensör	0(4)...20 mA	7760054182	94,00 €	1
EPAK-VI-VO	0...10 V	0...10 V	7760054175	127,00 €	1
EPAK-CI-VO	4...20 mA	0...10 V	7760054176	144,00 €	1
EPAK-PCI-VO	4...20 mA 2 kablolu sensör	0...10 V	7760054177	138,00 €	1
EPAK-VI-CO	0...10 V	4...20 mA	7760054178	121,00 €	1
DC/DC 3-Yollu Galvanik İzolasyon Sinyal Splitter					
EPAK-CI-2CO	1 x (0...20 mA, 4...20 mA)	2 x (0...20 mA, 4...20 mA)	7760054307	125,00 €	1
EPAK-CI-4CO	1 x (0...20 mA, 4...20 mA)	4 x (0...20 mA, 4...20 mA)	7760054308	145,00 €	1
DC/DC 2-Yollu İzolasyon, Giriş Döngü Beslemeli					
EPAK-CI-CO-ILP	4...20 mA (current loop)	4...20 mA	7760054179	83,00 €	1
EPAK-2CI-2CO-ILP	2 x 4...20 mA (current loop)	2 x 4...20 mA (current loop)	7760054180	99,00 €	1
Akım İzleme Modülleri					
EPAK-CM-CO-H	0.1...1A, 0.5...5A AC/DC	4...20 mA, Alarm output	7760054300	135,00 €	1
EPAK-CMR-1PH-5-24V	0.1...1A, 0.5...5A AC/DC	1 CO Alarm çıkışı (24V Besleme)	7760054246	120,00 €	1
EPAK-CMR-1PH-5-230V	0.1...1A, 0.5...5A AC/DC	1 CO Alarm çıkışı (230V Besleme)	7760054247	144,00 €	1
Gerilim İzleme Modülleri					
EPAK-VM-CO-H	0...300 V AC/DC, 0...125 V AC, 0...30 V DC	4...20 mA	7760054299	132,00 €	1
EPAK-VMR-1PH-300-24V	30...300 - 6...60 V AC/DC	1 CO Alarm çıkışı (24V Besleme)	7760054244	154,00 €	1
EPAK-VMR-1PH-300-230V	30...300 - 6...60 V AC/DC	1 CO Alarm çıkışı (230V Besleme)	7760054245	176,00 €	1
EPAK-VMR-3PH-PH	400V AC (L-L) ±15%	1 CO Alarm çıkışı	7760054248	83,00 €	1
PicoPac Serisi					
PICOPAK-CI-CO-LP-P	4...20 mA	4...20 mA	2501110000	125,00 €	1
PICOPAK-CI-CO-LP-S	4...20 mA	4...20 mA	2517450000	125,00 €	1
MCZ Serisi					
DC/DC Pasif Akım İzolatörü					
MCZ CCC 0-20mA/0-20mA	0(4)...20 mA	0(4)...20 mA	8411190000	150,00 €	10
PT100 Sıcaklık Dönüştürücü					
MCZ PT100/3 CLP 0...100C	0...100 °C 2/3 Kablolu	4...20 mA	8425720000	116,00 €	10
MCZ PT100/3 CLP 0...120C	0...120 °C 2/3 Kablolu	4...20 mA	8483680000	120,00 €	10
MCZ PT100/3 CLP 0...150C	0...150 °C 2/3 Kablolu	4...20 mA	8604420000	130,00 €	10
MCZ PT100/3 CLP 0...200C	0...200 °C 2/3 Kablolu	4...20 mA	8473010000	116,00 €	10
MCZ PT100/3 CLP 0...300C	0...300 °C 2/3 Kablolu	4...20 mA	8473020000	116,00 €	10
MCZ PT100/3 CLP-50C...+150C	-50...150 °C 2/3 Kablolu	4...20 mA	8473000000	116,00 €	10
MCZ PT100/3 CLP 40C...100C	-40...100 °C 2/3 Kablolu	4...20 mA	8604430000	116,00 €	10
Gerilim ve Akım Seviye İzleme					
MCZ SC 0-10V	0...10 V	2 PNP	8260280000	92,05 €	10
MCZ SC 0-20mA	0...20 mA	2 PNP	8227350000	92,05 €	10

Analog Sinyal Dönüştürücüler



JPP NPN PNP 24VDC



JP TEST



JPOVP RJ45 CAT6 IP20



JP CLIP M

Tip	Açıklama	Ürün İşlevi	Sipariş No	Fiyat/Birim	Ambalaj
JACKPAC IP68 Sinyal Dönüştürücüler					
* JPP NPN PNP 24VDC	18...30 V DC / 18...30 V DC	NPN / PNP Dönüştürücü	8852350000	86,95 €	1
* JPP PNP NPN 24VDC	18...30 V DC / 18...30 V DC	PNP / NPN Dönüştürücü	8857030000	100,00 €	1
* JPR 24VDC 1CO M12	24 V DC \pm 20 % / 24 V DC \pm 20 %	Röle Modülü	8771420000	76,35 €	1
* JPR 24VDC ISO 1CO M12	24 V DC \pm 20 % / 24 V	Röle Modülü	8771430000	72,45 €	1
* JPOVP RJ45 CAT6 IP20	III	RJ45 Yıldırım Koruma	8805550000	105,00 €	1
* JPO 24VDC 0.2A M12S	18...24...30 V DC / 3...33 V DC	Galvanik İzolasyonlu Solid State Röle	2465830000	128,00 €	1
* JP TEST	24 V DC \pm 25 % / 18...24...30 V DC	Test Adaptörü	8794120000	103,00 €	1
* JP CLIP M	-	Montaj Aparatı	8778490000	15,00 €	10

Enerji Analizörleri

Makine ve tesislerin enerji verimliliklerinin ölçülerek verimliliklerinin artırılması için elektriksel parametrelerin takibi ve izlenmesine ihtiyaç duyulmakta ve enerji yönetim yapıları oluşturulmaktadır.

Weidmüller genişleyen enerji izleme ürün ailesi ile tesislerin ve makinelerin ihtiyaç duyduğu izleme modülleri, enerji verimlilik analizörleri ve yardımcı ekipmanları ile enerji yönetim sistemlerinin tüm ihtiyaçlarına komple çözümler sunmaktadır.

ISO 50001 standartları dâhilinde kurulan enerji yönetim sistemlerinde enerji analizörlerinin önemli bir rolü vardır. Bu ürünlerin hafıza kayıt, ekranda okunan değerlerin gösterilmesi ve güç akış diyagramlarının analizleri konusunda yetkin olmaları gerekmektedir.

Weidmüller'in sunmuş olduğu enerji izleme modülleri ile tüm bu datalar kolaylıkla izlenir, kaydedilir ve analizleri ile sistemlerin enerji verimlilikleri standartlara uygun bir şekilde takip edilebilir.





ENERGY METER 330



ENERGY ANALYSER D550



ENERGY ANALYSER 550

Tip	Açıklama	Sipariş No	Fiyat/Birim	Ambalaj
Ray Tipi Şebeke Analizörleri				
ENERGY METER D650	Akım: 1/5 A, Gerilim L-L: 18...1000 Vrms, Gerilim L-N: 10...600 V AC, Class 0.5s, Tolerans: %0.2, Digital Input: 2, Digital Output: 2, Harmonik: 2. ve 40. distorsiyon arası, Memory: 4 MB, Protokol: Modbus RTU, UL sertifikasyonu	2425490000	1.188,00 €	1
Front Panel Tipi Şebeke Analizörleri				
ENERGY METER 330	Akım: 1/5 A, Gerilim L-L: 86 ... 442 Vrms, Gerilim L-N: 50 ...255 V AC, Class 2, Tolerans: %1	2425410000	359,00 €	1
ENERGY METER 350	Akım: 1/5 A, Gerilim L-L: 86 ... 442 Vrms, Gerilim L-N: 50 ... 255 V AC, Class 2, Tolerans: %1, Digital Output: 2	2425420000	463,00 €	1
ENERGY METER 520-230	Akım: 1/5 A, Gerilim L-L: 480V AC, Gerilim L-N: 280V AC, Class 0.5s, Tolerans: %0.2, Digital Input: 2, Digital Output: 2, Harmonik: 2. ve 40. distorsiyon arası, Memory: 4 MB, Protokol: Modbus RTU, UL sertifikasyonu	2500880000	634,00 €	1
ENERGY METER 520-24	Akım: 1/5 A, Gerilim L-L: 480V AC, Gerilim L-N: 280V AC, Class 0.5s, Tolerans: %0.2, Digital Input: 2, Digital Output: 2, Harmonik: 2. ve 40. distorsiyon arası, Memory: 4 MB, Protokol: Modbus RTU, UL sertifikasyonu	2500860000	634,00 €	1
ENERGY METER 700-PN-230	Akım: 1/5 A, Gerilim L-L: 480V AC, Gerilim L-N: 280V AC, Class 0.5s, Tolerans: %0.2, Digital Input: 2, Digital Output: 2, Harmonik: 2. ve 40. distorsiyon arası, Memory: 4 MB, Protokol: PROFINET, Modbus RTU, Modbus TCP/IP, Modbus RTU over Ethernet, SNMP, UL sertifikasyonu	2500890000	1.017,00 €	1
ENERGY METER 700-PN-24	Akım: 1/5 A, Gerilim L-L: 480V AC, Gerilim L-N: 280V AC, Class 0.5s, Tolerans: %0.2, Digital Input: 2, Digital Output: 2, Harmonik: 2. ve 40. distorsiyon arası, Memory: 4 MB, Protokol: PROFINET, Modbus RTU, Modbus TCP/IP, Modbus RTU over Ethernet, SNMP, UL sertifikasyonu	2500870000	1.100,00 €	1
POWER MONITOR	LCD Ekran, Modbus/RTU (RS485), V, I, Var, PF, F, °C	1423550000	417,00 €	1
POWER MONITOR 51A	LCD Ekran, Modbus/RTU (RS485), V, I, Var, PF, F, °C,	1470260000	484,00 €	1
Kalite Analizörleri				
ENERGY ANALYSER D550	Akım: 1/5 A, Gerilim L-L: 18...1000 Vrms, Gerilim L-N: 10...600 V AC, Class 0.5s, Tolerans: V: %0.2, A: %0.2, Harmonik: 2. ve 40. distorsiyon arası, Digital input: 2, Digital output: 2, Memory: 128 MB, Protokol: TCP/IP, DHCP Client (BootP), Modbus/TCP (Port 502), ICMP (Ping), NTP, Modbus RTU over Ethernet (Port 8000), TFTP	2425510000	1.600,00 €	1
ENERGY ANALYSER 550	Akım: 1/5 A, Gerilim L-L: 18...1000 Vrms, Gerilim L-N: 10...600 V AC, Class 0.2s, Tolerans: V: %0.1, A: %0.2, Harmonik: 2. ve 40. distorsiyon arası, Digital input: 8, Digital output: 5, Memory: 256 MB, Protokol: TCP/IP, DHCP Client (BootP), Modbus/TCP (Port 502), ICMP (Ping), NTP, Profibus DP VO, SMTP, TFTP, FTP, SNMP	2425500000	2.751,00 €	1
ENERGY ANALYSER 750-230	Akım: 1/5 A, Gerilim L-L: 600V AC Gerilim L-N: 347V AC, Protokol: Modbus RTU, Modbus-Gateway, Modbus TCP/IP, Modbus RTU over Ethernet, SNMP, Profibus DP VO, BACnet	2534130000	4.758,00 €	1
ENERGY ANALYSER 750-24	Akım: 1/5 A, Gerilim L-L: 600V AC Gerilim L-N: 347V AC, Protokol: Modbus RTU, Modbus-Gateway, Modbus TCP/IP, Modbus RTU over Ethernet, SNMP, Profibus DP VO, BACnet	2534160000	4.758,00 €	1
Enerji Logger				
ENERGY LOGGER D550		2425520000	954,00 €	1

Güç Kaynakları - ConnectPower

Güç kaynakları otomasyon sistemlerinin enerji beslemelerinde kullanılır. Weidmüller güç kaynakları uzun çalışma ömürleri ve verimlilikleri ile rakiplerinden farklılaşmaktadır.

PROmax / PROeco / PROtop

PROmax / PROeco serisi güç kaynakları stabil şekilde 5, 12, 24, 48 V DC güç değerini garanti eder ve az yer kaplar. 1 ve 3 fazlı olarak seçilebilir. Ray üzerinde aralarında boşluk bırakmadan monte edilebilir. Kritik uygulamalar için yüksek verimliliğe sahiptir. Buna rağmen aşırı yüklenmeye dayanıklı fazla rezervleri vardır. -25°C...+70°C arası geniş çalışma sıcaklığı aralığı hemen her ortamda güvenli kullanımı sağlar. Çok geniş giriş gerilim imkanı ile hem DC hem de AC de çalışabilir.

- 1 fazlı olarak: 3 A, 5 A, 7.5 A, 10 A, 20 A ve 40 A
- 3 fazlı olarak: 5 A, 10 A, 20 A ve 40 A

Regülesiz Güç Kaynakları

Kompakt yapıda olan bu güç kaynakları dinamik yükler için 36 W...1000W arası güç seçenekleri ile 24 Vdc gerilim sağlar. Giriş ve çıkış arasında izolasyon bir trafo ile sağlanır.

Özellikleri:

- Giriş gerilimi ~230V +/- ~15V veya ~400V +/- ~15V, 50/60 Hz
- Kısa devreye karşı emniyet sistemi
- Anahtar deliği şeklinde montaj yuvası ile zamandan tasarruf
- 144 W'a kadar 35mm DIN rayına monte edilebilir





PRO ECO 72W 24V 3A



PRO ECO3 120W 24V 5A



PRO DM 10



PRO MAX3 120W 24V 5A



PRO TOP1 72W 24V 3A



PRO TOP1 240W 24V 10A EX

Tip	Giriş	Çıkış	Sipariş No	Fiyat/Birim	Ambalaj
PROeco - Anahtarlama					
Tek Fazlı Sistemler					
PRO ECO 72W 24V 3A	85...264 V AC / 80...370 V DC	22...28 V DC 3A	1469470000	80,00 €	1
PRO ECO 120W 24V 5A	85...264 V AC / 80...370 V DC	22...28 V DC 5A	1469480000	105,00 €	1
PRO ECO 240W 24V 10A	85...264 V AC / 80...370 V DC	22...28 V DC 10A	1469490000	185,00 €	1
PRO ECO 480W 24V 20A	85...264 V AC / 80...370 V DC	22...28 V DC 20A	1469510000	260,00 €	1
PRO ECO 960W 24V 40A	85...264 V AC / 80...370 V DC	22...28 V DC 40A	1469520000	520,00 €	1
PRO ECO 72W 12V 6A	85...264 V AC / 80...370 V DC	10...16 V DC 6A	1469570000	90,00 €	1
PRO ECO 120W 12V 10A	85...264 V AC / 80...370 V DC	10...16 V DC 10A	1469580000	139,00 €	1
PRO ECO 240W 48V 5A	85...264 V AC / 80...370 V DC	42...56 V DC 5A	1469590000	160,00 €	1
PRO ECO 480W 48V 10A	85...264 V AC / 80...370 V DC	42...56 V DC 10A	1469610000	260,00 €	1
3 Fazlı Sistemler					
PRO ECO3 120W 24V 5A	3 x 500V...3 x 400 V AC / 450...800 V DC	22...28 V DC 5A	1469530000	135,00 €	1
PRO ECO3 240W 24V 10A	3 x 500V...3 x 400 V AC / 450...800 V DC	22...28 V DC 10A	1469540000	200,00 €	1
PRO ECO3 480W 24V 20A	3 x 500V...3 x 400 V AC / 450...800 V DC	22...28 V DC 20A	1469550000	290,00 €	1
PRO ECO3 960W 24V 40A	3 x 500V...3 x 400 V AC / 450...800 V DC	22...28 V DC 40A	1469560000	500,00 €	1
Diodye Modülleri					
* PRO DM 10	2 x 12 A (-40 °C ~ +45 °C), 2 x 10 A (+45 °C ~ +60 °C)	1 x 24 A (-40 °C ~ +45 °C), 1 x 20 A (+45 °C ~ +60 °C)	2486070000	75,00 €	1
* PRO DM 20	2 x 24 A (-40 °C ~ +45 °C), 2 x 20 A (+45 °C ~ +60 °C)	1 x 48 A (-40 °C ~ +45 °C), 1 x 40 A (+45 °C ~ +60 °C)	2486080000	130,00 €	1
PROmax Anahtarlama Güç Kaynakları					
Tek Fazlı Sistemler					
PRO MAX 70W 5V 14A	85...277 V AC / 80...370 V DC	4.5 - 7 V DC / 14 A (Pot)	1478210000	120,00 €	1
PRO MAX 72W 12V 6A	85...277 V AC / 80...370 V DC	10 - 15 V DC / 6 A (Pot)	1478220000	150,00 €	1
PRO MAX 120W 12V 10A	85...277 V AC / 80...370 V DC	10 - 15 V DC / 10 A (Pot)	1478230000	225,00 €	1
PRO MAX 72W 24V 3A	85...277 V AC / 80...370 V DC	22.5 - 29.5 V DC / 3 A (Pot)	1478100000	130,00 €	1
PRO MAX 120W 24V 5A	85...277 V AC / 80...370 V DC	22.5 - 29.5 V DC / 5 A (Pot)	1478110000	160,00 €	1
PRO MAX 180W 24V 7,5A	85...277 V AC / 80...370 V DC	22.5 - 29.5 V DC / 7.5 A (Pot)	1478120000	190,00 €	1
PRO MAX 240W 24V 10A	85...277 V AC / 80...370 V DC	22.5 - 29.5 V DC / 10 A (Pot)	1478130000	270,00 €	1
PRO MAX 480W 24V 20A	85...277 V AC / 80...370 V DC	22.5 - 29.5 V DC / 20 A (Pot)	1478140000	392,00 €	1
PRO MAX 960W 24V 40A	85...277 V AC / 80...370 V DC	22.5 - 29.5 V DC / 40 A (Pot)	1478150000	620,00 €	1
PRO MAX 240W 48V 5A	85...277 V AC / 80...370 V DC	30 - 56 V DC / 5 A (Pot)	1478240000	240,00 €	1
PRO MAX 480W 48V 10A	85...277 V AC / 80...370 V DC	30 - 56 V DC / 10 A (Pot)	1478250000	450,00 €	1
PRO MAX 960W 48V 20A	85...277 V AC / 80...370 V DC	30 - 56 V DC / 20 A (Pot)	1478270000	700,00 €	1
Üç Fazlı Sistemler					
PRO MAX3 120W 24V 5A	320-575 VAC/450-800VDC	22.5 - 29.5 V DC / 5 A (Pot)	1478170000	260,00 €	1
PRO MAX3 240W 24V 10A	320-575 VAC/450-800VDC	22.5 - 29.5 V DC / 10 A (Pot)	1478180000	310,00 €	1
PRO MAX3 480W 24V 20A	320-575 VAC/450-800VDC	22.5 - 29.5 V DC / 20 A (Pot)	1478190000	420,00 €	1
PRO MAX3 960W 24V 40A	320-575 VAC/450-800VDC	22.5 - 29.5 V DC / 40 A (Pot)	1478200000	675,00 €	1
Diodye Modülleri					
CP M DM20	2 X 10 A max veya 1 X 20 A / 24VDC		1222210000	95,65 €	1
CP M DM40	2 x 20 A max veya 1 X 40 A / 24VDC		1222220000	120,00 €	1
Kapasite Modülü					
CP M CAP	18...30 Vdc		1222240000	63,50 €	1
PROtop - Dynamic Current Limiting - Single/Paralel Mode - EX Alan İçin					
PRO TOP1 72W 24V 3A	85...277 V AC / 80 ... 410 V DC	22.5...29 V DC	2466850000	150,00 €	1
PRO TOP1 120W 24V 5A	85...277 V AC / 80 ... 410 V DC	22.5...29 V DC	2466870000	190,00 €	1
* PRO TOP1 120W 24V 5A EX	85...277 V AC / 80 ... 410 V DC	22.5...29 V DC	2466980000	200,00 €	1
PRO TOP1 240W 24V 10A	85...277 V AC / 80 ... 410 V DC	22.5...29 V DC	2466880000	270,00 €	1
* PRO TOP1 240W 24V 10A EX	85...277 V AC / 80 ... 410 V DC	22.5...29 V DC	2466990000	300,00 €	1

Serinin devamı sayfa 123



PRO TOP1 480W 24V 20A EX



PRO TOP1 960W 24V 40A EX



PRO INSTA 60W 12V 5A



CP DC UPS 24V 20A/10A



CP A BATTERY 24V DC3.4AH



PRO DCDC 120W 24V 5A

Tip	Giriş	Çıkış	Sipariş No	Fiyat/Birim	Ambalaj
PRO TOP1 480W 24V 20A	85...277 V AC / 80 ... 410 V DC	22.5...29 V DC	2466890000	380,00 €	1
* PRO TOP1 480W 24V 20A EX	85...277 V AC / 80 ... 410 V DC	22.5...29 V DC	2467000000	410,00 €	1
PRO TOP1 960W 24V 40A	85...277 V AC / 80 ... 410 V DC	22.5...29 V DC	2466900000	800,00 €	1
* PRO TOP1 960W 24V 40A EX	85...277 V AC / 80 ... 410 V DC	22.5...29 V DC	2467010000	750,00 €	1
PRO TOP1 480W 48V 10A	85...277 V AC / 80 ... 410 V DC	45...56 V DC	2467030000	462,00 €	1
PRO TOP1 960W 48V 20A	85...277 V AC / 80 ... 410 V DC	45...56 V DC	2466920000	660,00 €	1
PRO TOP1 120W 12V 10A	85...277 V AC / 80 ... 410 V DC	11...15 V DC	2466910000	225,00 €	1

Not: Diğer EX-PROOF ürünler için bizimle iletişime geçebilirsiniz.

Tip	Açıklama	Sipariş No	Fiyat/Birim	Ambalaj
PROtop - Dynamic Current Limiting - Single/Paralel Mode - EX Alan İçin				
PROtop Haberleşme Modülü				
* PRO COM CAN OPEN	PROTOP CANopen Haberleşme Modülü	2467320000	65,00 €	1
* PRO COM IO-LINK	PROTOP IO-LINK Haberleşme Modülü	2587360000	84,00 €	1
PROtop Haberleşme Kablosu				
PRO CAB SUBD-RJ45 0.5M	0.5 m (9 pin sub-D konektör / IP 20 RJ45)	2578530000	25,45 €	1
PRO CAB SUBD-RJ45 1.0M	1 m (9 pin sub-D konektör / IP 20 RJ45)	2578550000	27,00 €	1
PRO CAB SUBD-RJ45 2.5M	2.5 m (9 pin sub-D konektör / IP 20 RJ45)	2578560000	30,05 €	1

Tip	Giriş	Çıkış	Sipariş No	Fiyat/Birim	Ambalaj
INSTAPOWER - Anahtarlama					
* PRO INSTA 30W 5V 6A	85 - 264 V AC	5 V DC / 6 A	2580210000	50,00 €	1
* PRO INSTA 30W 12V 2.6A	85 - 264 V AC	12 V DC / 2.6 A	2580220000	48,00 €	1
* PRO INSTA 60W 12V 5A	85 - 264 V AC	12 V DC / 5 A	2580240000	60,00 €	1
* PRO INSTA 16W 24V 0.7A	85 - 264 V AC	24 V DC / 0.7 A	2580180000	32,00 €	1
* PRO INSTA 30W 24V 1.3A	85 - 264 V AC	24 V DC / 1.3 A	2580190000	48,00 €	1
* PRO INSTA 60W 24V 2.5A	85 - 264 V AC	24 V DC / 2.5 A	2580230000	60,00 €	1
* PRO INSTA 96W 24V 4A	85 - 264 V AC	24 V DC / 3.8 A	2580260000	75,00 €	1
* PRO INSTA 90W 24V 3.8A	85 - 264 V AC	24 V DC / 4 A	2580250000	75,00 €	1
* PRO INSTA 96W 48V 2A	85 - 264 V AC	48 V DC / 2 A	2580270000	75,00 €	1

Tip	Giriş	Sipariş No	Fiyat/Birim	Ambalaj
UPS Kontrol - Batarya - Buffer modülleri				
CP DC UPS 24V 20A/10A	UPS Kontrol modülü 24 Vdc, 20 A / 10 A	1370050010	296,00 €	1
CP DC UPS 24V 40A	UPS Kontrol modülü 24 Vdc, 40A	1370040010	488,00 €	1
* CP A BATTERY 24V DC1.3AH	Batarya 3min @ 10A	1406930000	240,00 €	1
CP A BATTERY 24V DC3.4AH	Batarya 11,3 min @ 10 A / 5 min @ 20 A	1251070000	200,00 €	1
CP A BATTERY 24V DC7.2AH	Batarya 26,5 min @ 10 A / 11,5 min @ 20 A / 5 min @ 30 A	1251080000	240,00 €	1
CP A BATTERY 24V DC12AH	Batarya 51 min @ 10 A / 22,7 min @ 20 A / 9,2 min @ 30 A	1251090000	400,00 €	1
CP A BATTERY 24V DC17AH	Batarya 81 min @ 10 A / 34,2 min @ 20 A / 13,5 min @ 30 A	1251110000	460,00 €	1
CP DC BUFFER 24V 20A	Buffer modülü 24 Vdc, 20 A,	1251220000	292,00 €	1

Tip	Giriş	Çıkış	Sipariş No	Fiyat/Birim	Ambalaj
DC/DC Konvertör					
PRO DCDC 120W 24V 5A	24 V DC	22.5...29.5 V DC 5A	2001800000	155,00 €	1
PRO DCDC 240W 24V 10A	24 V DC	22.5...29.5 V DC 10A	2001810000	260,00 €	1
PRO DCDC 480W 24V 20A	24 V DC	22.5...29.5 V DC 20A	2001820000	330,00 €	1
DCDC 24V-120V 230W	24 V DC	96 V DC / 144 V DC, 2A	1507190000	686,00 €	1

Tip	Açıklama	Sipariş No	Fiyat/Birim	Ambalaj
Redundancy Modülleri				
PRO RM 10 10 ... 32 V DC	2 × 10 A Eşit Yük Paylaşımı için Redundancy Modülü	2486090000	135,00 €	1
PRO RM 20 10 ... 32 V DC	2 × 20 A Eşit Yük Paylaşımı için Redundancy Modülü	2486100000	180,00 €	1
PRO RM 40 10 ... 32 V DC	2 × 40 A Eşit Yük Paylaşımı için Redundancy Modülü	2486110000	205,00 €	1



FreeCon



TGD FIM-C

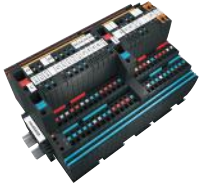

maxGUARD



AMG FIM-0



AMG ELM-6D CO



AMG OD

Tip	Giriş	Sipariş No	Fiyat/Birim	Ambalaj
FreeCon Wireless Enerji Aktarım Modülü				
IE-CL240W-PP-BASE	Primary Side 24V DC	1547440000	1.200,00 €	1
IE-CL240W-PP-REMOTE	Secondary side 10A-0.5mm	1547450000	1.000,00 €	1
IE-CL-MOUNT-CLIP	Clip Aparatı	1994360000	Sorunuz	1
IE-CL-MOUNT-PROFILE	Montaj Profili	1994370000	Sorunuz	1

Tip	Açıklama	Sipariş No	Fiyat/Birim	Ambalaj
topGUARD Elektronik Sigorta Modülleri				
* TGD FIM-C	IO-LINK Eklenebilir Besleme Modülü	2625000000	105,00 €	1
* TGD ELM-12	4-12A Ayarlanabilir Sigorta Modülü	2624990000	74,00 €	1
* TGD ELM-4 CL2	4A Sigorta Modülü	2656670000	68,00 €	1
* TGD ELM-6	1-6A Ayarlanabilir Sigorta Modülü	2624980000	70,00 €	1
* PRO COM IO-LINK	IO-LINK Haberleşme Modülü	2587360000	84,00 €	1

maxGUARD Elektronik Sigorta Modülleri				
maxGUARD Besleme Modülleri				
AMG FIM-0	18 ... 31.2 V DC, 40A Pasif Dağıtım Bloğu	2081870000	7,15 €	1
AMG FIM-C	18 ... 31.2 V DC, 40A Dağıtım Bloğu, Alarm ve Reset Fonksiyonlu	2081880000	31,25 €	1
AMG FIM-0 Ex	18 ... 31.2 V DC, 40A Pasif Dağıtım Bloğu Ex	2082530000	9,00 €	1
AMG FIM-C Ex	18 ... 31.2 V DC, 40A Dağıtım Bloğu, Alarm ve Reset Fonksiyonlu Ex	2082540000	40,00 €	1

maxGUARD Elektronik Sigorta Modülleri				
AMG ELM-1F	1A Sabit Değer	2080420000	33,75 €	1
AMG ELM-2F	2A Sabit Değer	2080480000	33,75 €	1
AMG ELM-4F	4A Sabit Değer	2080490000	35,00 €	1
AMG ELM-6F	6A Sabit Değer	2080500000	35,00 €	1
AMG ELM-8F	8A Sabit Değer	2080600000	36,25 €	1
AMG ELM-10F	10A Sabit Değer	2080650000	36,25 €	1
AMG ELM-Q2222	4 Kanal 2A sabit	2080750000	113,00 €	1
AMG ELM-Q2244	4 Kanal 2 x 2A, 2 x 4A	2081650000	113,00 €	1
AMG ELM-Q2266	4 Kanal 2 x 2A, 2 x 6A	2081820000	125,00 €	1
AMG ELM-Q4444	4 Kanal 4 x 4A	2080880000	113,00 €	1
AMG ELM-Q6666	4 Kanal 4 x 6A	2080920000	125,00 €	1
AMG ELM-1F CL2	1A Sabit Değer, Class 2 aproved	2491270000	37,15 €	1
AMG ELM-2F CL2	2A Sabit Değer, Class 2 aproved	2491280000	37,15 €	1
AMG ELM-4F CL2	4A Sabit Değer, Class 2 aproved	2491290000	38,50 €	1
AMG ELM-6	6A'e Kadar Ayarlanabilir	2080360000	42,50 €	1
AMG ELM-12	12A'e Kadar Ayarlanabilir	2080410000	48,00 €	1
AMG ELM-1F EX	1A Sabit Değer Ex	2082040000	37,50 €	1
AMG ELM-2F EX	2A Sabit Değer Ex	2082050000	37,50 €	1
AMG ELM-4F EX	4A Sabit Değer Ex	2082060000	45,00 €	1
AMG ELM-6F EX	6A Sabit Değer Ex	2082310000	48,00 €	1
AMG ELM-8F EX	8A Sabit Değer Ex	2082320000	52,00 €	1
AMG ELM-10F EX	10A Sabit Değer Ex	2082430000	42,50 €	1
AMG ELM-6 EX	6A'e Kadar Ayarlanabilir Ex	2082000000	52,25 €	1
AMG ELM-12 EX	12A'e Kadar Ayarlanabilir Ex	2082010000	56,25 €	1

maxGUARD Elektronik Yük İzleme				
AMG ELM-6D CO	6A röle çıkışlı	2082440000	59,50 €	1
AMG ELM-10D CO	10A röle çıkışlı	2082470000	63,75 €	1

maxGUARD Potansiyel Dağıtım Klemensleri				
AMG DIS	Ölçme Ayırma Klemensi	2123050000	4,95 €	10
AMG MD	4 x Negatif	2122930000	2,25 €	10
AMG OD	2 x Pozitif, 2 x Negatif	2122910000	2,25 €	10

Serinin devamı sayfa 125

Tip	Açıklama	Sipariş No	Fiyat/Birim	Ambalaj
AMG PD	4 x Pozitif	2122920000	2,25 €	10
AMG OD EX	2 x Pozitif, 2 x Negatif Ex	2495090000	3,05 €	10
AMG PD EX	4 x Pozitif Ex	2495070000	3,05 €	10
AMG MD EX	4 x Negatif Ex	2495040000	3,05 €	10
AMG XMD EX	4 x Negatif Ex	2495080000	3,50 €	10
AMG DIS EX	Ölçme Ayırma Klemensi Ex	2495100000	6,00 €	10
maxGUARD Alarm Modülü				
AMG AM	(2 x NO)	2081890000	33,75 €	1
AMG AM CO	(2 x NO) Ex	2082770000	36,25 €	1
maxGUARD Kontrol Modülü				
AMG CM	Operasyon duruş ve erken uyarı modülü	2081900000	31,25 €	1
AMG CM EX	Operasyon duruş ve erken uyarı modülü Ex	2083360000	35,00 €	1
maxGUARD Aksesuarları				
AMG PP	Ayırma Plakası	2123000000	1,35 €	40
AMG EP	Sonlandırma Plakası	2495380000	3,00 €	30
Turuncu Tarak Köprü				
ZQV 4N/2	2 pole	1527930000	4,98 TL	60
ZQV 4N/3	3 pole	1527940000	9,12 TL	60
ZQV 4N/4	4 pole	1527970000	13,60 TL	60
ZQV 4N/5	5 pole	1527980000	17,90 TL	60
ZQV 4N/6	6 pole	1527990000	22,25 TL	20
ZQV 4N/7	7 pole	1528020000	26,45 TL	20
ZQV 4N/8	8 pole	1528030000	30,85 TL	20
ZQV 4N/9	9 pole	1528070000	34,90 TL	20
ZQV 4N/10	10 pole	1528090000	40,15 TL	20
ZQV 4N/50	50 pole	1528130000	229,10 TL	5
Mavi Tarak Köprü				
ZQV 4N/2 BL	2 pole	1528040000	4,92 TL	60
ZQV 4N/3 BL	3 pole	1528080000	8,88 TL	60
ZQV 4N/4 BL	4 pole	1528120000	13,25 TL	60
ZQV 4N/5 BL	5 pole	1528140000	17,40 TL	60
ZQV 4N/6 BL	6 pole	1528170000	21,70 TL	20
ZQV 4N/7 BL	7 pole	1528180000	25,75 TL	20
ZQV 4N/8 BL	8 pole	1528190000	30,05 TL	20
ZQV 4N/9 BL	9 pole	1528220000	34,15 TL	20
ZQV 4N/10 BL	10 pole	1528230000	39,10 TL	20
ZQV 4N/50 BL	50 pole	1528240000	223,20 TL	5
Kırmızı Tarak Köprü				
ZQV 4N/2	2 pole	2460450000	4,92 TL	60
ZQV 4N/3	3 pole	2460810000	8,88 TL	60
ZQV 4N/4	4 pole	2460800000	13,25 TL	60
ZQV 4N/5	5 pole	2460790000	17,40 TL	60
ZQV 4N/6	6 pole	2460780000	21,70 TL	20
ZQV 4N/7	7 pole	2460770000	25,75 TL	20
ZQV 4N/8	8 pole	2460760000	30,05 TL	20
ZQV 4N/9	9 pole	2460750000	34,15 TL	20
ZQV 4N/10	10 pole	2460740000	39,10 TL	20
ZQV 4N/50	50 pole	2460730000	223,20 TL	5



AMG AM



ZQV 4N/4



ZQV 4N/4 BL



ZQV 4N/4

Güç Kaynakları



CP E SNT 25W 5V 5A



CP E SNT 50W 5V 10A



CP E SNT 100W 5V 16A



CP E SNT 150W 12V 12.5A



CP E SNT 250W 12V 21A

Tip	Giriş	Çıkış	Sipariş No	Fiyat/Birim	Ambalaj
PRO-E					
Tek Faz 25W Sistemler					
CP E SNT 25W 5V 5A	85...264 V AC/110...370 V DC	5VDC / 5A	1202640000	21,25 €	1
CP E SNT 25W 12V 2.1A	85...264 V AC/110...370 V DC	12VDC / 2,1A	1202630000	22,30 €	1
CP E SNT 25W 24V 1.1A	85...264 V AC/110...370 V DC	24VDC / 1.1 A	1202620000	22,65 €	1
CP E SNT 25W 48V 0.57A	85...264 V AC/110...370 V DC	48VDC /0,57A	1202610000	21,25 €	1
Tek Faz 50W Sistemler					
CP E SNT 50W 5V 10A	85...264 V AC/110...370 V DC	5VDC / 10A	1202590000	32,30 €	1
CP E SNT 50W 12V 4.2A	85...264 V AC/110...370 V DC	12VDC / 4.2A	1202580000	32,30 €	1
CP E SNT 50W 24V 2.2A	85...264 V AC/110...370 V DC	24VDC / 2.2A	1202450000	32,80 €	1
CP E SNT 50W 48V 1.1A	85...264 V AC/110...370 V DC	48VDC / 1.1A	1202460000	30,75 €	1
Tek Faz 75W Sistemler					
CP E SNT 75W 5V 12A	85...264 V AC/110...370 V DC	5VDC / 12A	1202470000	35,50 €	1
CP E SNT 75W 12V 6A	85...264 V AC/110...370 V DC	12VDC / 6A	1202480000	35,50 €	1
CP E SNT 75W 48V 1.6A	85...264 V AC/110...370 V DC	48VDC / 1.6A	1202510000	35,50 €	1
Tek Faz 100W Sistemler					
CP E SNT 100W 5V 16A	88...132 V AC / 176...264 V AC ops./250...370 V DC	5VDC / 16A	1165820000	45,60 €	1
CP E SNT 100W 12V 8.5A	88...132 V AC / 176...264 V AC ops./250...370 V DC	12VDC / 8.5A	1165830000	45,60 €	1
CP E SNT 100W 24V 4.5A	88...132 V AC / 176...264 V AC ops./250...370 V DC	24VDC / 4.5A	1165840000	45,60 €	1
CP E SNT 100W 48V 2.3A	88...132 V AC / 176...264 V AC ops./250...370 V DC	48VDC / 2.3A	1165850000	45,60 €	1
Tek Faz 150W Sistemler					
CP E SNT 150W 12V 12.5A	88...132 V AC / 176...264 V AC ops./250...370 V DC	12VDC / 12.5A	1165870000	51,70 €	1
CP E SNT 150W 24V 6.5A	88...132 V AC / 176...264 V AC ops./250...370 V DC	24VDC / 6.5A	1165880000	55,15 €	1
CP E SNT 150W 48V 3.3A	88...132 V AC / 176...264 V AC ops./250...370 V DC	48VDC / 3.3A	1165890000	51,70 €	1
Tek Faz 250W Sistemler					
CP E SNT 250W 12V 21A	88...132 V AC / 176...264 V AC ops./250...370 V DC	12VDC / 21A	1202520000	83,55 €	1
CP E SNT 250W 24V 10.5A	88...132 V AC / 176...264 V AC ops./250...370 V DC	24VDC / 10.5A	1202530000	78,30 €	1
CP E SNT 250W 48V 5.2A	88...132 V AC / 176...264 V AC ops./250...370 V DC	48VDC / 5.2A	1202540000	78,30 €	1
BRACKET 250W	raya montaj parçası		7760052061	3,45 €	1
Tek Faz 350W Sistemler					
CP E SNT 350W 24V 14.6A	85...264 V AC/110...370 V DC	24VDC / 14.6A	1202550000	118,00 €	1
CP E SNT 350W 48V 7.3A	85...264 V AC/110...370 V DC	48VDC / 7.3A	1202560000	118,00 €	1
BRACKET 250W	raya montaj parçası		7760052061	3,45 €	1

Aşırı Gerilim Koruma Modülleri

Weidmüller aşırı gerilim koruma modülleri normal değerleri aşan gerilim piklerini sınır noktasına ulaşmadan çalışma gerilimine indirir. İzolasyon koordinasyonu DIN VDE 0110 standartlarında belirtilen değerlerden daha iyi değerlere sahiptir. İyi bir aşırı gerilim koruma modülü şu kriterlerden belli olur:

- Hızlı reaksiyon
- Yıldırım akımı taşıma kapasitesi
- Çok az artı gerilim

Weidmüller bu kriterleri tamamıyla karşılayan ürünler imal eder. Ürünler, kullanılacak yere göre tek bir komponent, ya da bu komponentlerin kombinasyonlarından oluşur.

Aşırı gerilim koruma sınıfı Tip 1

Ana trafolarla tesis edilir. Yıldırım düştüğü zaman kendilerinden sonra gelen ekipmanları korur.

Aşırı gerilim koruma sınıfı Tip 2

Kullanım yeri alt dağıtım panelleridir. Uzak yıldırım etkilerine ve şebekeden gelen piklere karşı etkilidir.

Aşırı gerilim koruma sınıfı Tip 3

Son cihazların korunması için kullanılır. Koruma seviyeleri daha hassastır.

Tamamıyla bir koruma sağlamak için bütün riskleri göz önünde bulundurmamak gerekir. En son cihaza yapılan koruma hiçbir zaman yakın yıldırıma karşı koruma sağlamaz

Aşırı Gerilim Koruma Modüllerinin Ölçü Kontrol Devrelerinde Kullanımı (MSR)

Weidmüller ölçü kontrol devreleri için koruma modüllerini ilk olarak 20 yıl önce üretti. Değişik gerilim aşma komponentleri kullanılarak sürekli geliştirilen ürünler sayesinde Weidmüller çok kapsamlı çözümler sunmaktadır. Ürün portföyünde klemenslere entegre edilmiş, vidalı, yaylı veya push in bağlantı teknolojilerine sahip çok sayıda alternatifler bulunmaktadır.

Uygulamalar:

- 0 (4)-20 mA Analog sinyaller
- 0-10V Analog sinyaller
- Digital sinyaller
- Analog şalt sinyaller



Aşırı Gerilim Koruma Modülleri



VPU I 1 R LCF 280V/25KA



VPU I 3 LCF 280V/25KA



VPU I 1 R 280V/12,5KA



VPU AC II 1 300/50



VPU AC II 3+1 300/50



VPU III R 230V/6KV AC



VPU III SO LD+A

Tip	Açıklama	Sipariş No	Fiyat/Birim	Ambalaj
Class I (B Sınıfı)				
VPU I 1 R LCF 280V/25KA	8/20 µs deşarj akım:25kA, 1 faz	1351570000	195,00 €	1
VPU I 1+1 R LCF 280V/25KA	8/20 µs deşarj akım:25kA, 1 faz+ 1 Nötr	1351740000	347,00 €	1
VPU I 3 R LCF 280V/25KA	8/20 µs deşarj akım:25kA, 3 faz	1351670000	558,00 €	1
VPU I 3+1 R LCF 280V/25KA	8/20 µs deşarj akım:25kA, 3 faz+1 Nötr	1351770000	737,00 €	1
VPU I 1 LCF 280V/35KA	10/350 µs deşarj akım:35kA	1351350000	259,00 €	1
VPU I 1 N-PE 260V/100KA	N-PE,8/20µs deşarj akım:100kA	1351920000	180,00 €	1
Class I+II (B+C) (3 Faz + Nötr)				
VPU I 3 LCF 280V/25KA	8/20 µs deşarj akım:25kA, 3 faz,Tip I+II/Röle çıkışı yok	1351690000	528,00 €	1
VPU I 3+1 LCF 280V/25KA	8/20 µs deşarj akım:25kA, 3 faz+ 1 Nötr,Tip I+II/Röle çıkışı yok	1351780000	702,00 €	1
Class I+II (B+C)				
VPU I 1 R 280V/12,5KA	10/350 µs deşarj akım:12,5kA, 1 faz,Tip I+II, Röle Çıkışlı	1352140000	80,00 €	1
VPU I 2 R 280V/12,5KA	10/350 µs deşarj akım:12,5kA, 2 faz,Tip I+II, Röle Çıkışlı	1352170000	150,00 €	1
VPU I 3 R 280V/12,5KA	10/350 µs deşarj akım:12,5kA, 3 faz,Tip I+II, Röle Çıkışlı	1352220000	250,00 €	1
VPU I 4 R 280V/12,5KA	10/350 µs deşarj akım:12,5kA, 4 faz,Tip I+II, Röle Çıkışlı	1352190000	289,00 €	1
VPU I 1 280V/12,5KA	10/350 µs deşarj akım:12,5kA, 1 faz,Tip I+II, Röle Çıkışı yok	1352130000	85,00 €	1
VPU I 2 280V/12,5KA	10/350 µs deşarj akım:12,5kA, 2 faz,Tip I+II, Röle Çıkışı yok	1352150000	133,00 €	1
VPU I 3 280V/12,5KA	10/350 µs deşarj akım:12,5kA, 3 faz,Tip I+II, Röle Çıkışı yok	1352200000	193,00 €	1
VPU I 4 280V/12,5KA	10/350 µs deşarj akım:12,5kA, 4 faz,Tip I+II, Röle Çıkışı yok	1352180000	257,00 €	1
VPU I 3+1 280V/12,5KA	10/350 µs deşarj akım:12,5kA, 3 faz+ 1 Nötr,Tip I+II, Röle Çıkışı yok	1352230000	364,00 €	1
VPU I 3+1 R 280V/12,5KA	10/350 µs deşarj akım:12,5kA, 3 faz+ 1 Nötr,Tip I+II, Röle Çıkışlı	1352240000	396,00 €	1
Class II (C Sınıfı)				
* VPU AC II 1 R 300/50	8/20 µs deşarj akım:20kA, 1 faz, Tip II, Röle çıkışlı	2591030000	46,00 €	1
* VPU AC II 2 R 300/50	8/20 µs deşarj akım:20kA, 2 faz, Tip II, Röle çıkışlı	2591050000	80,00 €	1
* VPU AC II 3 R 300/50	8/20 µs deşarj akım:20kA, 3 faz, Tip II, Röle çıkışlı	2591170000	130,00 €	1
* VPU AC II 4 R 300/50	8/20 µs deşarj akım:20kA, 4 faz, Tip II, Röle çıkışlı	2591150000	126,00 €	1
* VPU AC II 1 300/50	8/20 µs deşarj akım:20kA, 1 faz, Tip II, Röle çıkışı yok	2591020000	32,00 €	1
* VPU AC II 2 300/50	8/20 µs deşarj akım:20kA, 2 faz, Tip II, Röle çıkışı yok	2591040000	72,00 €	1
* VPU AC II 3 300/50	8/20 µs deşarj akım:20kA, 3 faz, Tip II, Röle çıkışı yok	2591160000	110,00 €	1
* VPU AC II 4 300/50	8/20 µs deşarj akım:20kA, 4 faz, Tip II, Röle çıkışı yok	2591140000	122,00 €	1
Class II (C Sınıfı) TN ve TT sistem				
* VPU AC II 1+1 R 300/50	8/20 µs deşarj akım:20kA, 1 faz + 1 Nötr, Tip II, Röle çıkışlı	2591070000	84,00 €	1
* VPU AC II 3+1 R 300/50	8/20 µs deşarj akım:20kA, 3 faz + 1 Nötr, Tip II, Röle çıkışlı	2591090000	150,00 €	1
* VPU AC II 1+1 300/50	8/20 µs deşarj akım:20kA, 1 faz + 1 Nötr, Tip II, Röle çıkışı yok	2591060000	72,00 €	1
* VPU AC II 3+1 300/50	8/20 µs deşarj akım:20kA, 3 faz + 1 Nötr, Tip II, Röle çıkışı yok	2591080000	119,00 €	1
Class III (D Sınıfı)				
VPU III R 230V/6KV AC	8/20 µs deşarj akım:3kA,230VAC, Tip III	1351650000	80,00 €	1
VPU III R 120V/6KV AC/DC	8/20 µs deşarj akım:3kA,120VAC/DC, Tip III	1351630000	69,50 €	1
VPU III R 48V/4KV AC/DC	8/20 µs deşarj akım:2kA,48VAC/DC, Tip III	1351600000	69,50 €	1
VPU III R 24V/4KV AC/DC	8/20 µs deşarj akım:2kA,24VAC/DC, Tip III	1351580000	75,00 €	1
VPU III R 12V/4KV AC/DC	8/20 µs deşarj akım:2kA,12VAC/DC, Tip III	1351550000	69,50 €	1
Class III (D Sınıfı) Seyyar Tip				
VPU III SO LD+A	Tip III priz koruma, akustik alarm	1351700000	53,50 €	1
VPU III SO LD	Tip III priz koruma	1351680000	53,50 €	1
Koaksiyel Kablolar İçin Yıldırım Korumalar				
BNC Connector / M-F	Video, 8/20 µs deşarj akım:20kA	8947820000	100,00 €	1
N Connector / M-F	GSM, 8/20 µs deşarj akım:20kA	8947830000	149,00 €	1
F Connector / M-F	SAT, 8/20 µs deşarj akım:20kA	8947840000	135,00 €	1
UHF Connector / M-F	Analog, 8/20 µs deşarj akım:20kA	8947850000	76,40 €	1



VARITECTOR LOGGER 30



VSPC 1CL 24VDC R



VSPC 2SL 5VDC R

Tip	Açıklama	Sipariş No	Fiyat/Birim	Ambalaj
Aşırı Gerilim İzleme Modülü				
VARITECTOR LOGGER 30	LCD, max. puls sayısı: 80, 8/20 µs max. deşarj akım dayanımı 40kA	1428780000	514,00 €	1
Analog Sinyaller İçin Ani Aşırı Gerilim Korumalar				
VSPC 1CL 5VDC R	20 kA, 1 Kanal, Alarm	8951530000	140,00 €	1
VSPC 1CL 12VDC R	20 kA, 1 Kanal, Alarm	8951540000	140,00 €	1
VSPC 1CL 24VDC R	20 kA, 1 Kanal, Alarm	8951550000	140,00 €	1
VSPC 1CL 24VAC R	20 kA, 1 Kanal, Alarm	8951560000	140,00 €	1
VSPC 2CL 5VDC R	20 kA, 2 Kanal, Alarm	8951460000	193,00 €	1
VSPC 2CL 12VDC R	20 kA, 2 Kanal, Alarm	8951470000	193,00 €	1
VSPC 2CL 24VDC R	20 kA, 2 Kanal, Alarm	8951480000	193,00 €	1
VSPC 1CL 5VDC	20 kA, 1 Kanal	8924420000	91,00 €	1
VSPC 1CL 12VDC	20 kA, 1 Kanal	8924450000	91,00 €	1
VSPC 1CL 24VDC	20 kA, 1 Kanal	8924480000	91,00 €	1
VSPC 1CL 24VAC	20 kA, 1 Kanal	8924500000	91,00 €	1
VSPC 1CL 48VAC	20 kA, 1 Kanal	8924520000	91,00 €	1
VSPC 1CL 60VAC	20 kA, 1 Kanal	8924530000	91,00 €	1
VSPC 2CL 5VDC	20 kA, 2 Kanal	8924400000	172,00 €	1
VSPC 2CL 12VDC	20 kA, 2 Kanal	8924440000	172,00 €	1
VSPC 2CL 24VDC	20 kA, 2 Kanal	8924470000	172,00 €	1
VSPC 2CL 24VAC	20 kA, 2 Kanal	8924490000	172,00 €	1
VSPC 2CL 48VAC	20 kA, 2 Kanal	8951490000	172,00 €	1
VSPC BASE 1CL R	1 Kanal, Alarm, Doğrudan Topraklama	8951730000	42,90 €	1
VSPC BASE 1CL FG R	1 Kanal, Alarm Dolaylı Topraklama	8951740000	42,90 €	1
VSPC BASE 1CL	1 Kanal, Doğrudan Topraklama	8924730000	32,00 €	1
VSPC BASE 1CL FG	1 Kanal, Spark Gap ile Doğrudan	8924290000	37,50 €	1
VSPC BASE 2CL R	2 Kanal, Alarm, Doğrudan Topraklama	8951710000	64,25 €	1
VSPC BASE 2CL FG R	2 Kanal, Alarm Dolaylı Topraklama	8951720000	72,90 €	1
VSPC BASE 2CL	2 Kanal, Doğrudan Topraklama	8924710000	54,50 €	1
VSPC BASE 2CL FG	2 Kanal Spark Gap ile Doğrudan	8924270000	58,90 €	1
Dijital Sinyal İçin Ani Aşırı Gerilim Korumalar				
VSPC 2SL 5VDC R	20 kA, 2 Kanal, Alarm / 5 V DC / 300 mA	8951610000	140,00 €	1
VSPC 2SL 12VDC R	20 kA, 2 Kanal, Alarm / 12 V DC / 300 mA	8951620000	140,00 €	1
VSPC 2SL 24VDC R	20 kA, 2 Kanal, Alarm / 24 V DC / 300 mA	8951630000	140,00 €	1
VSPC 2SL 24VAC R	20 kA, 2 Kanal, Alarm / 24 V AC / 300 mA	8951640000	140,00 €	1
VSPC 4SL 5VDC R	20 kA, 4 Kanal, Alarm / 5 V DC / 350 mA	8951570000	230,00 €	1
VSPC 4SL 12VDC R	20 kA, 4 Kanal, Alarm / 12 V DC / 300 mA	8951580000	230,00 €	1
VSPC 4SL 24VDC R	20 kA, 4 Kanal, Alarm / 24 V DC / 300 mA	8951590000	230,00 €	1
VSPC 4SL 24VAC R	20 kA, 4 Kanal, Alarm / 24 V AC / 300 mA	8951600000	230,00 €	1
VSPC 2SL 5VDC	20 kA, 2 Kanal / 5 V DC / 300 mA	8924210000	99,60 €	1
VSPC 2SL 12VDC	20 kA, 2 Kanal / 12 V DC / 300 mA	8924230000	99,60 €	1
VSPC 2SL 24VDC	20 kA, 2 Kanal / 24 V DC / 300 mA	8924330000	99,60 €	1
VSPC 2SL 24VAC	20 kA, 2 Kanal / 24 V AC / 300 mA	8924350000	99,60 €	1
VSPC 2SL 48VAC	20 kA, 2 Kanal / 48 V AC / 250 mA	8924370000	99,60 €	1
VSPC 4SL 5VDC	20 kA, 4 Kanal / 5 V DC / 350 mA	8924200000	193,00 €	1
VSPC 4SL 12VDC	20 kA, 4 Kanal / 12 V DC / 300 mA	8924220000	193,00 €	1
VSPC 4SL 24VDC	20 kA, 4 Kanal / 24 V DC / 300 mA	8924320000	193,00 €	1
VSPC 4SL 24VAC	20 kA, 4 Kanal / 24 V AC / 300 mA	8924340000	193,00 €	1
VSPC 4SL 48VAC	20 kA, 4 Kanal / 48 V AC / 250 mA	8924360000	193,00 €	1
VSPC 4SL 60VAC	20 kA, 4 Kanal / 60 V AC / 200 mA	8924380000	193,00 €	1
VSPC BASE 2SL R	2 Kanal, Alarm, Doğrudan Topraklama, Taban	8951770000	42,80 €	1
VSPC BASE 2SL FG R	2 Kanal, Alarm Dolaylı Topraklama, Taban	8951780000	42,80 €	1

Serinin devamı sayfa 130

Aşırı Gerilim Koruma Modülleri



MCZ OVP HF 5V 0,3A



VSPC 1CL 5VDC EX



VDATA CAT6



V-TEST

Tip	Açıklama	Sipariş No	Fiyat/Birim	Ambalaj
VSPC BASE 2SL	2 Kanal, Spark Gap ile Dolaylı, Taban	8924720000	32,00 €	1
VSPC BASE 2SL FG	2 Kanal, Doğrudan Topraklama, Taban	8924280000	37,50 €	1
VSPC BASE 4SL R	4 Kanal, Alarm Doğrudan Topraklama, Taban	8951750000	69,50 €	1
VSPC BASE 4SL FG R	4 Kanal, Alarm Dolaylı Topraklama, Taban	8951760000	69,50 €	1
VSPC BASE 4SL	4 Kanal, Doğrudan Topraklama, Taban	8924700000	58,90 €	1
VSPC BASE 4SL FG	4 Kanal, Spark Gap ile Dolaylı, Taban	8924260000	64,50 €	1

MCZ Serisi Yıldırım Korumalar

MCZ OVP HF 5V 0,3A	5 V UC / 0,3 A	8948620000	289,05 TL	10
MCZ OVP HF 12V 0,3A	12 V UC / 0,3A	8948610000	289,05 TL	10
MCZ OVP HF 24V 0,3A	24 V UC / 0,3 A	8948600000	291,45 TL	10
MCZ OVP CL 24VDC 0,5A	24 V DC / 0,5 A	8448920000	325,00 TL	10
MCZ OVP CL 24VAC 0,5A	24 V AC / 0,5 A	8472880000	293,80 TL	10
MCZ OVP CL 24VUC 1,25A	24 V UC / 1,25 A	8448960000	318,60 TL	10
MCZ OVP CL 48VUC 0,5A	48 V UC / 0,5 A	8449000000	351,20 TL	10
MCZ OVP CL 48VUC 1,25A	48 V UC / 1,25 A	8449040000	426,85 TL	10
MCZ OVP CL FG 24VUC 0,5A	24 V UC / 0,5 A	8704240000	428,80 TL	10
MCZ OVP SL 24VDC 0,5A	24 V DC / 0,5 A	8448940000	325,00 TL	10
MCZ OVP SL 24VUC 1,25A	24 V UC / 1,25 A	8448970000	319,30 TL	10
MCZ OVP SL 48VUC 0,5A	48 V UC / 0,5 A	8449030000	360,55 TL	10
MCZ OVP SL 48VUC 1,25A	48 V UC / 1,25 A	8449050000	372,40 TL	10
MCZ OVP SL FG 24VUC 0,5A	24 V UC / 0,5 A	8823280000	355,55 TL	10
MCZ OVP VARISTOR S10K30	24 V AC / 24 V DC / 16 A	8449140000	195,95 TL	10
MCZ OVP TAZ DIODE 24VDC	24 V DC / 16 A	8449150000	199,00 TL	10
MCZ OVP TAZ DIODE 24VUC	24 V UC / 16 A	8449160000	191,00 TL	10

Varitector - Patlayıcı Ortamlar için Ani Aşırı Gerilim Korumaları

Analog Sinyal Korumaları

VSPC 1CL 5VDC EX	20 kA, 1 Kanal, 5Vdc	8953660000	129,00 €	1
VSPC 1CL 12VDC EX	20 kA, 1 Kanal, 12Vdc	8953590000	129,00 €	1
VSPC 1CL 24VDC EX	20 kA, 1 Kanal, 24Vdc	8953600000	129,00 €	1
VSPC 2CL 24VDC EX	20 kA, 2 Kanal, 24Vdc	8953720000	193,00 €	1
VSPC BASE 1CL FG EX	1 Kanal, Taban	8951810000	53,50 €	1
VSPC BASE 2CL FG EX	2 Kanal, Taban	8951820000	85,70 €	1

Dijital Sinyal Korumaları

VSPC 2SL 12VDC EX	20 kA, 2 Kanal, 12VDC	8953620000	129,00 €	1
VSPC 2SL 24VDC EX	20 kA, 2 Kanal, 24VDC	8953670000	129,00 €	1
VSPC 2SL 48VAC EX	20 kA, 2 Kanal, 48VDC	8953640000	129,00 €	1
VSPC 4SL 12VDC EX	20 kA, 4 Kanal, 12 VDC	1161170000	247,00 €	1
VSPC 4SL 24VDC EX	20 kA, 4 Kanal, 24VDC	1161190000	247,00 €	1
VSPC 4SL 24VAC EX	20 kA, 4 Kanal, 48VAC	1161180000	247,00 €	1
VSPC BASE 2SL FG EX	2 Kanal, Taban	8951830000	53,50 €	1
VSPC BASE 4SL FG EX	4 Kanal, Taban	8951840000	85,70 €	1

Cat 6 RJ45 Aşırı Gerilim Koruma

VDATA CAT6	Data hatları için aşırı gerilim koruma modülü	1348590000	141,00 €	1
------------	---	------------	----------	---

V-Test Cihazları

V-TEST	IEC 62305 PU I ve PU II için	8951860000	1.480,00 €	1
--------	------------------------------	------------	------------	---

Uygulamaya Özel Çözümler



Fotovoltaik Sistemler için Ürünler ve Çözümleri

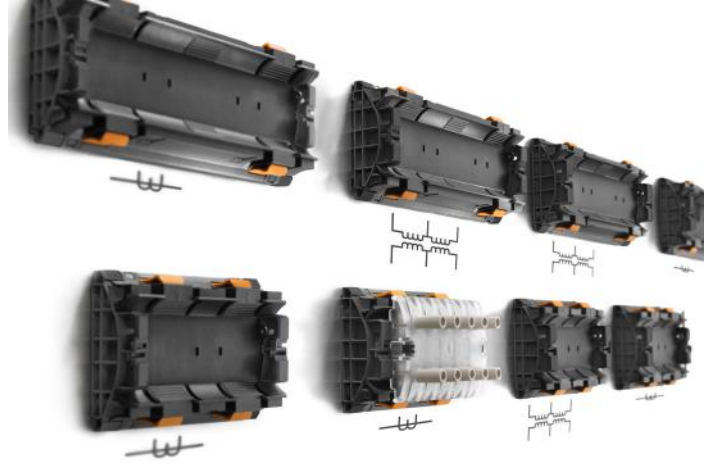

POCON Akım ve Gerilim Test Kutuları



Pick to Light Çözümleri



FieldPower Güç Dağıtım Çözümleri

Uygulamaya Özel Çözümler



PV-STICK SET



PV-STICK SET+VPE10



PV-STICK - VPE10



BUGH WM4 C BT



WM4C PV
Saha Konnektörleri



SET MULTI-TOOL PV+



DC Combiner Box Çözümleri



VPU PV I+II 3 1000



WSI 25 10X85 1.5KV,14x85 gPV

Tip	Açıklama	Kablo Kesiti	Sipariş No	Fiyat/Birim	Ambalaj
PV Sistemler İçin Ürünler ve Çözümler					
PV SYF Konnektörler					
PV-STICK SET	PV-Stick Erkek-Dişi Set	4mm ² - 6 mm ² kablo kesitine uygun	1422030000	7,10 €	1
PV-STICK + VPE10	PV-Stick Dişi 10'lu paket	4mm ² - 6 mm ² kablo kesitine uygun	1303450000	3,10 €	10
PV-STICK - VPE10	PV-Stick Erkek 10'lu paket	4mm ² - 6 mm ² kablo kesitine uygun	1303490000	3,10 €	10
PV-STICK + VPE50	PV-Stick Dişi 50'li paket	4mm ² - 6 mm ² kablo kesitine uygun	1303460000	3,50 €	50
PV-STICK - VPE50	PV-Stick Erkek 50'li paket	4mm ² - 6 mm ² kablo kesitine uygun	1303500000	3,50 €	50
PV-STICK + VPE200	PV-Stick Dişi 200'li paket	4mm ² - 6 mm ² kablo kesitine uygun	1303470000	3,05 €	200
PV-STICK - VPE200	PV-Stick Erkek 200'li paket	4mm ² - 6 mm ² kablo kesitine uygun	1303510000	3,05 €	200

WM4C PV Saha Konnektörleri

BUGH WM4 C BT	Dişi Konnektör	4mm ² - 6 mm ² kablo kesitine uygun	1530690000	1,25 €	100
SFGH WM4 C BT	Erkek Konnektör	4mm ² - 6 mm ² kablo kesitine uygun	1530700000	1,25 €	100
SFKO WM4 C BT	Erkek Kontak	4mm ² - 6 mm ² kablo kesitine uygun	1530680000	1,25 €	100
BUKO WM4 C BT	Dişi Kontak	4mm ² - 6 mm ² kablo kesitine uygun	1530670000	1,25 €	100
SFKO WM4 C BT	Erkek Kontak (Rulo şeklinde gelmektedir)	4mm ² - 6 mm ² kablo kesitine uygun	1530770000	1,20 €	4500
BUKO WM4 C BT	Dişi Kontak (Rulo şeklinde gelmektedir)	4mm ² - 6 mm ² kablo kesitine uygun	1530780000	1,20 €	4500

Hızlı ve Güvenilir Bağlantı / 30A kadar nominal akımlı yükler / TÜV sertifikalı ve en son DIN EN 50521 standardı ile uyumlu

WM4C PV Combiner Box Konnektörleri

BUGH BOX WM4 C BT	Dişi Konnektör	4mm ² - 6 mm ² kablo kesitine uygun	1530630000	1,25 €	100
SFGH BOX WM4 C BT	Erkek Konnektör	4mm ² - 6 mm ² kablo kesitine uygun	1530640000	1,25 €	100
SFKO WM4 C BT	Erkek Kontak	4mm ² - 6 mm ² kablo kesitine uygun	1530680000	1,25 €	100
BUKO WM4 C BT	Dişi Kontak	4mm ² - 6 mm ² kablo kesitine uygun	1530670000	1,25 €	100

Tip	Açıklama	Sipariş No	Fiyat/Birim	Ambalaj
Aksesuarlar				
SET MULTI-TOOL PV+	Konnektör Sıkıcı	1217280000	25,00 €	1
multi-stripax PV	Kablo Soyucu	1190490000	383,00 €	1
CTF PV WM4	Kontak Sıkma Pensesi	1222870000	5.400,00 TL	1
VSSO WM4 C	Erkek ve Dişi Gövdeleri için Üniversal Toz Kapağı(Toz Tapası)	1254870000	0,65 €	100

İzleme Sistemi

TC 16i+ 1K5 (standalone)	TC 16i+ 1K5 (standalone)	2433950000	880,00 €	1
TC BKE 1k5.4 (standalone)	BKE PV 1500V Güç Kaynağı	7791400879	350,00 €	1
PV KIT TC 16i+ 1K5 & BKE 1K5.4	1500V 16 String izleme + BKE Güç Kaynağı Paketi	7512000541	Sorunuz	Sorunuz
PVKIT TC 16i+ 1K5 & BKE 1K5.4 & SPD	1500V 16 String OVP korumalı izleme + Güç Kaynağı Paketi	7512000542	Sorunuz	Sorunuz
PV KIT TC16i+1k5 & SPD	1500V 16 String OVP korumalı izleme	7512000543	Sorunuz	Sorunuz

1 String için 30A DC / Modbus RTU over RS-485 / Analog ve Dijital girişler / Şönt Rezistans

Saha ve Çatı Uygulamaları için Combiner Box Çözümleri

DC Combiner Box	Müşteriye özel dizayn Combiner Box	Sorunuz	Sorunuz	Sorunuz
DC Combiner Box PV-Next	Çatı uygulamaları için PV Combiner Box	Sorunuz	Sorunuz	Sorunuz
Konnektörlü DC Combiner Box	Müşteriye özel dizayn Combiner Box	Sorunuz	Sorunuz	Sorunuz

Koruma Sistemleri

VPU PV I+II 3 1000	PV Parafudr, Tip I+II, 1100 V DC, 40kA	2530610000	151,00 €	1
VPU PV II 3 R 1000	PV Parafudr, Tip II 1100 V DC, 40kA, remote sinyalli	2530180000	90,00 €	1
VPU PV II 3 1000	PV Parafudr, Tip II, 1100 V DC, 40kA	2530550000	72,00 €	1
VPU PV I+II 3 R 1000	PV Parafudr, Tip I+II 1100 V DC, 40kA, remote sinyalli	2530620000	162,00 €	1
VPU PV I+II 3 1500	PV Parafudr, Tip I+II 1500 V DC, 30 kA, limp: 5kA	2530580000	164,00 €	1
VPU PV I+II 3 R 1500	PV Parafudr, Tip I+II 1500 V DC, 30 kA, limp: 5kA, remote sinyalli	2530590000	176,00 €	1
VPU PV II 3 1500	PV Parafudr, Tip II 1500V DC, 30kA, limp: 5kA	2530640000	98,00 €	1
VPU PV II 3 R 1500	PV Parafudr, Tip II 1500V DC, 30kA, limp: 5kA, remote sinyalli	2530650000	108,00 €	1

PV Uygulamalarına Özel 1500V Sigorta Yuvası

WSI 25 10X85 1.5KV,14x85 gPV	1000V (AC) / 1500V (DC) / 32A	2469360000	228,60 TL	5
------------------------------	-------------------------------	------------	-----------	---



KIT KLTR 2TR POCON 4



KIT KLTR 4TR POCON 8



PTL DPD ADVANCED SQR FIXATION



FP Box



PTS 4

Tip	Açıklama	Sipariş No	Fiyat/Birim	Ambalaj
-----	----------	------------	-------------	---------

Akım ve Gerilim Test Kutusu**POCON 4 Akım ve Gerilim Test Kutusu**

* KIT KLTR 2TR POCON 4	POCON 4 Terminal	1052150000	Sorunuz	Sorunuz
* SDST 2TR POCON 4	POCON 4 Kapak	1052160000	Sorunuz	Sorunuz
* TCN 2TR POCON 4	POCON 4 Test Soketi	1052180000	Sorunuz	Sorunuz
* QV 2POL POCON	2 kutuplu köprü	1091670000	Sorunuz	Sorunuz
* QV 3POL POCON	3 kutuplu köprü	1091680000	Sorunuz	Sorunuz
* KOEL POCON	Ayırma elementi	1091690000	Sorunuz	Sorunuz

POCON 8 Akım ve Gerilim Test Kutusu

* KIT KLTR 4TR POCON 8	POCON 8 Terminal	1052140000	Sorunuz	Sorunuz
* SDST 4TR POCON 8	POCON 8 Kapak	1052170000	Sorunuz	Sorunuz
* TCN 4TR POCON 8	POCON 8 Test Soketi	1052080000	Sorunuz	Sorunuz
* QV 2POL POCON	2 kutuplu köprü	1091670000	Sorunuz	Sorunuz
* QV 3POL POCON	3 kutuplu köprü	1091680000	Sorunuz	Sorunuz
* KOEL POCON	Ayırma elementi	1091690000	Sorunuz	Sorunuz

Tip	Açıklama	Sipariş No	Fiyat/Birim	Ambalaj
-----	----------	------------	-------------	---------

Pick to Light

* PTL DPD BASIC RD FIXATION	M12 Konnektörlü, 4-digite Ekran, Yuvarlak Bağlantı Aparatı	7508001876	162,00 €	1
* PTL DPD BASIC SQR FIXATION	M12 Konnektörlü, 4-digite Ekran, Kare Bağlantı Aparatı	7508001928	180,00 €	1
* PTL DPD ADVANCED RD FIXATION	M12 Konnektörlü, 4-digite Ekran, Input için M8 Sensör bağlantısı, Yuvarlak Bağlantı Aparatı	7508001907	206,00 €	1
* PTL DPD ADVANCED SQR FIXATION	M12 Konnektörlü, 4-digite Ekran, Input için M8 Sensör bağlantısı, Kare Bağlantı Aparatı	7508002014	206,00 €	1

Tip	Açıklama	Sipariş No	Fiyat/Birim	Ambalaj
-----	----------	------------	-------------	---------

FieldPower Güç Dağıtım Çözümleri**FieldPower Güç Dağıtım Klemensi**

FP Box	IP65 5 Kutup	1957580000	70,00 €	1
FP Box 10P	IP65 10 Kutup	1957590000	130,00 €	1
PowerTerminal LG	IP30 5 Kutup Bağlantı Modülü	1963570000	50,15 €	1
PT6	IP20 5 Kutup Bağlantı Modülü	1957620000	36,25 €	1
FP Box FUSE	IP65 Sinyal Modülü	1961780000	153,00 €	1
FP Box ON/OFF	IP65 Bakım (A) Anahtar	1003260000	245,00 €	1

FieldPower Asansör Uygulamaları

FP ESWB LANDING SET	230V / 6A	2483990000	169,30 TL	1
FP ESWB TERMINAL SET	230V / 6A	2524850000	172,45 TL	1

FieldPower Güç Dağıtım Klemensi Aksesuarlar

PTS 4	Push-In Bağlantılı Konnektör	1952120000	12,95 €	10
PTDS 4	Her Kutup için İki Bağ. Konnektör	1952130000	14,35 €	10
RKDG D9 PT6	Yuvarlak Kablo Tutucu	4329610000	3,35 €	10
RKDG D11 PT6	Yuvarlak Kablo Tutucu	4323210000	3,35 €	10
RKDG D13 PT6	Yuvarlak Kablo Tutucu	4323230000	3,35 €	10
RKDG D15 PT6	Yuvarlak Kablo Tutucu	4323220000	3,50 €	10
DG DO PT6	Yassı Kablo Tutucu	4323240000	3,35 €	10

Ürün Sıralı Listesi

Ürün Kodu	Birim Fiyat	Sayfa No	Ürün Kodu	Birim Fiyat	Sayfa No	Ürün Kodu	Birim Fiyat	Sayfa No	Ürün Kodu	Birim Fiyat	Sayfa No
0100000000			0389000000	24,42 TL	8	0400000000			1013740000	35,40 TL	49
0117500000	44,00 TL	73	0400000000			0550160000	4,47 €	50	1013750000	40,45 TL	49
0119660000	21,84 TL	50	0430500000	12,12 TL	4	0556660000	27,66 TL	10	1013760000	45,60 TL	49
0119760000	21,84 TL	50	0430500000	12,12 TL	15	0565600000	0,317 TL	69	1013770000	50,05 TL	49
0119860000	25,08 TL	50	0430600000	14,00 TL	4	0565700000	0,575 TL	69	1013780000	55,20 TL	49
0119960000	26,28 TL	50	0430600000	14,00 TL	15	0565800000	0,751 TL	69	1013790000	60,40 TL	49
0120060000	27,66 TL	50	0430700000	12,12 TL	4	0565900000	0,701 TL	69	1015220000	0,95 €	78
0122800000	85,80 TL	73	0430700000	12,12 TL	15	0566000000	0,964 TL	69	1015230000	1,05 €	78
0126160000	25,08 TL	50	0430700000	12,12 TL	4	0573200000	8,70 €	66	1015240000	1,05 €	78
0126260000	25,08 TL	50	0430900000	12,12 TL	4	0573300000	21,43 €	66	1015250000	1,30 €	78
0137100000	2,48 €	50	0430900000	12,12 TL	15	0573400000	20,00 €	66	1015270000	1,45 €	78
0164000000	21,84 TL	74	0444200000	3,50 TL	69	0573500000	25,42 €	66	1015280000	1,70 €	78
0169900000	4,44 TL	8	0459500000	9,60 TL	10	0573600000	77,65 €	66	1015290000	2,10 €	78
0171111687	0,341 TL	35	0462900000	0,131 TL	69	0573700000	109,77 €	66	1015300000	2,40 €	78
0178100000	21,84 TL	74	0463000000	0,131 TL	69	0576261198	0,650 TL	34	1015310000	1,40 €	78
0186100000	0,188 TL	69	0463100000	0,131 TL	69	0576261199	0,650 TL	34	1015320000	1,60 €	78
0186500000	0,175 TL	69	0468660001	0,650 TL	34	0576261202	0,650 TL	34	1015330000	2,50 €	78
0191860000	9,42 TL	6	0468660051	0,650 TL	34	0576261203	0,650 TL	34	1015340000	2,45 €	78
0191900000	0,300 TL	69	0468660101	0,650 TL	34	0586761001	70,00 €	50	1015350000	2,80 €	78
0194300000	3,82 TL	8	0468660151	0,650 TL	34	0587160000	25,08 TL	50	1016030000	2,82 TL	39
0194400000	6,00 TL	8	0468660201	0,650 TL	34	0600000000			1016200000	46,90 TL	5
0194500000	7,00 TL	8	0473460001	0,650 TL	34	0620120000	109,20 TL	10	1016700000	45,60 TL	3
0200000000			0473460051	0,650 TL	34	0620220000	76,38 TL	10	1016900000	46,25 TL	3
0213760000	21,84 TL	50	0473460101	0,650 TL	34	0620202000	66,18 TL	10	1017700000	51,00 TL	3
0213811687	0,341 TL	35	0473460151	0,650 TL	34	0620320000	66,18 TL	10	1018190000	2,82 TL	39
0236400000	102,66 TL	73	0473460201	0,650 TL	34	0620420000	47,52 TL	10	1018600000	99,60 TL	3
0236500000	105,18 TL	73	0475360000	10,08 TL	10	0631961187	0,650 TL	34	1018790000	25,00 €	98
0243520000	80,40 TL	10	0475380000	8,34 TL	10	0631961203	0,650 TL	34	1018800000	62,00 TL	3
0244100000	0,250 TL	69	0492500000	0,500 TL	69	0632760000	28,32 TL	50	1018840000	21,00 €	98
025211xxxx	0,341 TL	35	0494920000	47,52 TL	74	0635100000	0,240 TL	69	1019000000	56,50 TL	3
025261xxxx	0,341 TL	35	0500000000			0641720000	53,94 TL	10	1019100000	86,10 TL	5
0266500000	13,50 TL	10	0502660000	21,24 TL	10	0644960000	258,60 TL	56	1019570000	13,10 €	75
0267200000	20,16 TL	8	0502680000	21,24 TL	10	0648661001	70,00 €	50	1019700000	691,00 TL	3
0273820000	20,00 TL	10	0502860000	15,36 TL	10	0687900000	10,26 TL	50	1020000000	4,80 TL	2
0273920000	21,84 TL	10	0502880000	15,36 TL	10	0690700000	0,131 TL	69	1020080000	4,80 TL	2
0274020000	29,52 TL	10	0508401694	13,53 €	35	1000000000			1020100000	6,00 TL	2
0274220000	40,44 TL	10	0514200000	52,62 TL	73	1002690000	180,00 €	68	1020180000	6,00 TL	2
0274420000	73,32 TL	10	0514400000	107,64 TL	73	1002700000	405,00 €	68	1020200000	10,15 TL	2
0274620000	76,38 TL	10	0514500000	61,44 TL	73	1002710000	326,00 €	68	1020280000	10,15 TL	2
0282600000	0,097 TL	69	0518960001	0,650 TL	34	1002720000	259,00 €	68	1020300000	13,80 TL	2
0282800000	0,161 TL	69	0518960011	0,650 TL	34	1002730000	247,00 €	68	1020380000	13,80 TL	2
0282900000	0,350 TL	69	0518960021	0,650 TL	34	1002740000	197,00 €	68	1020400000	18,60 TL	2
0291660000	889,02 TL	56	0518960031	0,650 TL	34	1002750000	189,00 €	68	1020480000	18,60 TL	2
0292460000	14,88 TL	36	0518960041	0,650 TL	34	1002760000	479,00 €	68	1020500000	41,80 TL	2
0299860000	17,34 TL	10	0518960051	0,650 TL	34	1003260000	245,00 €	133	1020580000	41,80 TL	2
0300000000			0518960061	0,650 TL	34	1010000000	20,20 TL	3	1021290000	11,00 €	90
0307300000	28,98 TL	9	0518960071	0,650 TL	34	1010060000	30,00 €	90	1021320000	11,20 €	90
0316500000	5,52 TL	10	0518960081	0,650 TL	34	1010070000	26,00 €	90	1021480000	11,00 €	90
0316600000	10,68 TL	10	0518960091	0,650 TL	34	1010080000	24,65 €	90	1021500000	16,60 TL	2
0317000000	1,60 TL	69	0522361075	0,650 TL	34	1010090000	26,00 €	90	1021510000	11,20 €	90
0317100000	1,90 TL	69	0522361076	0,650 TL	34	1010100000	26,65 TL	3	1021580000	18,95 TL	2
0317200000	2,00 TL	69	0522361077	0,650 TL	34	1010120000	35,30 TL	3	1022300000	62,20 TL	2
0317300000	2,70 TL	69	0523060001	0,650 TL	34	1010130000	36,55 TL	3	1022600000	78,35 TL	4
0318000000	11,52 TL	9	0523060011	0,650 TL	34	1010140000	53,35 TL	3	1023300000	78,35 TL	4
0334900000	11,52 TL	50	0523060021	0,650 TL	34	1010150000	84,80 TL	3	1023400000	78,35 TL	4
0335700000	12,00 TL	8	0523060031	0,650 TL	34	1010168000	34,15 TL	3	1023500000	78,35 TL	4
0338300000	15,00 TL	8	0523060041	0,650 TL	34	1010178000	34,75 TL	3	1023600000	109,85 TL	4
0342000000	16,06 €	66	0523060051	0,650 TL	34	1010188000	39,20 TL	3	1023700000	6,00 TL	4
0342100000	25,42 €	66	0523060061	0,650 TL	34	1010198000	46,25 TL	3	1023780000	6,00 TL	4
0342200000	21,43 €	66	0523060071	0,650 TL	34	1011000000	33,25 TL	4	1024140000	280,00 €	35
0342300000	28,13 €	66	0523060081	0,650 TL	34	1011300000	81,65 TL	4	1024500000	470,20 TL	2
0342400000	56,21 €	66	0523060091	0,650 TL	34	1012200000	81,65 TL	4	1024580000	470,20 TL	2
0342500000	62,91 €	66	0525960000	14,52 TL	10	1012300000	81,65 TL	4	1024600000	334,10 TL	2
0342600000	93,71 €	66	0525980000	14,52 TL	10	1012400000	81,65 TL	4	1024680000	334,10 TL	2
0354361187	0,650 TL	34	0531760000	7,44 TL	9	1013680000	10,00 TL	49	1024700000	29,00 TL	2
0382860000	5,94 TL	6	0533500000	0,414 TL	69	1013690000	15,10 TL	49	1025220000	2,27 TL	36
0383400000	57,00 TL	73	0534200000	0,550 TL	69	1013710000	20,00 TL	49	1025230000	2,27 TL	36
0383560000	6,00 TL	6	0542500000	0,125 TL	69	1013720000	25,10 TL	49	1025260000	2,52 TL	37
			0545300000	110,00 TL	9	1013730000	30,10 TL	49	1025270000	2,52 TL	37
									1025310000	2,82 TL	37
									1025320000	2,82 TL	37

Ürün Kodu	Birim Fiyat	Sayfa No	Ürün Kodu	Birim Fiyat	Sayfa No	Ürün Kodu	Birim Fiyat	Sayfa No	Ürün Kodu	Birim Fiyat	Sayfa No
1247290000	75,10 TL	11	1282560000	70,00 TL	49	1315170000	45,00 €	80	1327730000	13,00 TL	41
1247310000	84,80 TL	3	1282660000	69,90 TL	50	1315180000	68,00 €	80	1327740000	19,20 TL	41
1247310000	84,80 TL	11	1282760000	73,90 TL	50	1315190000	57,00 €	80	1327750000	15,70 TL	41
1247420000	120,80 TL	3	1282820000	490,10 TL	55	1315200000	98,00 €	80	1327770000	20,75 TL	41
1247420000	120,80 TL	11	1282820000	490,10 TL	55	1315210000	117,00 €	80	1327780000	19,20 TL	41
1247430000	133,50 TL	3	1286530000	529,00 €	94	1315220000	49,50 €	80	1327790000	24,05 TL	41
1247430000	133,50 TL	11	1286540000	317,00 €	94	1315230000	80,00 €	80	1327800000	64,10 TL	41
1248580000	7,50 TL	40	1286550000	317,00 €	94	1315240000	78,00 €	80	1327820000	96,35 TL	41
1248590000	7,50 TL	40	1286560000	290,00 €	94	1315250000	118,00 €	80	1327830000	40,15 TL	41
1248610000	7,50 TL	40	1286570000	533,00 €	94	1315270000	135,00 €	80	1327840000	51,60 TL	41
1248620000	10,30 TL	40	1286580000	602,00 €	94	1315350000	57,00 €	80	1327850000	31,40 TL	41
1248630000	10,30 TL	40	1286590000	1.100,00 €	94	1315370000	81,50 €	80	1327870000	39,60 TL	41
1248640000	10,30 TL	40	1286610000	1.292,00 €	94	1315390000	109,00 €	80	1327880000	15,70 TL	41
1248650000	15,05 TL	40	1286620000	1.600,00 €	94	1315400000	116,00 €	80	1327890000	21,85 TL	41
1248660000	15,05 TL	40	1286780000	1.318,00 €	95	1315410000	63,00 €	80	1327900000	13,00 TL	41
1248670000	15,05 TL	40	1286790000	2.006,00 €	95	1315420000	95,00 €	80	1327920000	19,20 TL	41
1250360000	13,80 TL	50	1286800000	2.006,00 €	95	1315430000	92,00 €	80	1331600000	1.000,00 €	35
1250370000	17,35 TL	50	1286810000	2.559,00 €	95	1315440000	120,00 €	80	1333100000	0,186 TL	69
1251070000	200,00 €	123	1286820000	2.370,00 €	95	1315450000	135,00 €	80	1334490000	910,00 €	115
1251080000	240,00 €	123	1286830000	2.988,00 €	95	1315540000	127,00 €	81	1334710000	45,00 €	82
1251090000	400,00 €	123	1286840000	2.988,00 €	95	1315550000	120,00 €	81	1334740000	45,00 €	82
1251110000	460,00 €	123	1286860000	850,00 €	94	1315570000	180,00 €	81	1334770000	32,50 €	82
1251220000	292,00 €	123	1286870000	847,00 €	94	1315580000	205,00 €	81	1334780000	32,50 €	82
1254870000	0,65 €	132	1286920000	609,00 €	94	1315590000	210,00 €	81	1334790000	32,50 €	82
1261300000	9,60 TL	10	1286930000	2.097,00 €	95	1315600000	210,00 €	81	1334800000	32,50 €	82
1267790000	462,50 TL	30	1286940000	2.097,00 €	95	1315610000	250,00 €	81	1334810000	32,50 €	82
1267800000	462,50 TL	30	1286970000	2.925,00 €	95	1315620000	225,00 €	81	1334890000	405,00 €	80
1267810000	462,50 TL	30	1286990000	3.546,00 €	95	1315650000	234,00 €	81	1334900000	405,00 €	80
1267820000	462,50 TL	30	1287000000	3.546,00 €	96	1315670000	235,00 €	81	1334910000	369,00 €	80
1267830000	211,90 TL	29	1287010000	3.872,00 €	95	1315680000	260,00 €	81	1334920000	410,00 €	80
1267840000	211,90 TL	29	1287020000	2.733,00 €	96	1315690000	250,00 €	81	1334940000	400,00 €	80
1267870000	227,40 TL	30	1289200000	0,700 TL	77	1315700000	222,00 €	81	1334950000	580,00 €	80
1267880000	227,40 TL	30	1289400000	0,900 TL	77	1315710000	234,00 €	82	1334990000	600,00 €	80
1267890000	109,85 TL	29	1296000000	995,00 TL	59	1315720000	265,00 €	81	1335030000	233,00 €	81
1267900000	109,85 TL	29				1315730000	285,00 €	81	1335040000	267,00 €	81
1267910000	117,60 TL	30				1315740000	240,00 €	81	1335050000	260,00 €	81
1267920000	117,60 TL	30				1315750000	250,00 €	81	1335140000	973,00 TL	115
1268360000	889,00 TL	56				1315770000	27,00 €	82	1338650000	155,00 €	35
1270040000	16,15 TL	11				1318061198	0,650 TL	34	1338670000	155,00 €	35
1270070000	59,15 TL	11				1318061199	0,650 TL	34	1338680000	155,00 €	35
1270080000	105,40 TL	11				1318061202	0,650 TL	34	1338690000	155,00 €	35
1274660000	169,80 TL	60				1318220000	361,00 €	115	1338710000	262,00 €	35
1274670000	200,35 TL	60				1318640000	1,81 TL	37	1338720000	570,00 €	35
1274680000	241,70 TL	60				1318650000	1,91 TL	37	1339610000	51,00 €	98
1274690000	315,70 TL	60				1318660000	2,00 TL	37	1339920000	1,50 €	82
1274710000	224,20 TL	60				1318670000	2,00 TL	37	1341030000	1.794,00 TL	42
1274720000	302,65 TL	60				1318680000	2,09 TL	37	1341040000	1.794,00 TL	42
1274730000	259,15 TL	60				1318690000	2,17 TL	37	1341050000	1.794,00 TL	42
1274740000	359,30 TL	60				1318710000	2,00 TL	37	1341070000	1.794,00 TL	42
1274750000	1.163,00 TL	60				1318720000	2,00 TL	38	1341080000	1.794,00 TL	42
1275100000	229,30 TL	109				1318730000	2,09 TL	38	1341090000	1.794,00 TL	42
1276960001	0,690 TL	34				1318740000	2,09 TL	38	1341100000	1.794,00 TL	42
1276960011	0,690 TL	34				1318750000	2,17 TL	38	1341110000	1.794,00 TL	42
1276960021	0,690 TL	34				1318760000	2,09 TL	38	1341120000	2.690,00 TL	42
1276960031	0,690 TL	34				1319270000	160,00 €	111	1341130000	6,00 TL	42
1276960041	0,690 TL	34				1319280000	170,00 €	111	1341140000	2,52 TL	42
1278600000	0,070 TL	77				1320060000	12,70 TL	49	1341150000	4,44 TL	42
1278700000	0,160 TL	77				1320160000	19,20 TL	49	1341170000	3,60 TL	42
1278800000	0,300 TL	77				1324260000	19,20 TL	50	1341180000	3,84 TL	42
1278900000	0,427 TL	77				1324380000	5,700,00 €	35	1341620000	0,726 TL	35
1279000000	0,530 TL	77				1324460000	21,85 TL	50	1341630000	0,902 TL	82
1279100000	1,14 TL	77				1327600000	64,10 TL	41	1344760000	374,00 €	96
1281760000	10,85 TL	49				1327620000	96,35 TL	41	1344770000	1.419,00 €	95
1281860000	16,15 TL	49				1327630000	12,70 TL	41	1345240000	2.122,00 €	95
1281960000	28,00 TL	49				1327640000	17,80 TL	41	1345270000	1.580,00 €	96
1282060000	29,60 TL	49				1327650000	40,15 TL	41	1345310000	19.500,00 TL	63
1282160000	42,00 TL	49				1327670000	51,60 TL	41	1345320000	24.500,00 TL	64
1282260000	49,00 TL	49				1327680000	31,40 TL	42	1345330000	4.800,00 TL	64
1282360000	56,00 TL	49				1327690000	39,60 TL	41	1346610000	12,00 €	82
1282460000	53,75 TL	49				1327700000	15,70 TL	41	1348590000	141,00 €	98
1282490000	63,00 €	115				1327720000	21,85 TL	41	1348590000	141,00 €	130

Ürün Kodu	Birim Fiyat	Sayfa No	Ürün Kodu	Birim Fiyat	Sayfa No	Ürün Kodu	Birim Fiyat	Sayfa No	Ürün Kodu	Birim Fiyat	Sayfa No
1764300000	1,91 TL	39	1784790000	26,00 €	90	1811190000	4,86 TL	50	1828450000	1,06 TL	108
1768000000	79,60 TL	14	1790410000	9,66 TL	40	1812630000	8,04 TL	40	1828450000	1,06 TL	110
1768010000	12,20 TL	16	1790420000	10,55 TL	40	1812870000	22,95 €	91	1828610000	207,00 €	89
1771800000	61,60 TL	15	1790430000	9,36 TL	40	1812890000	23,20 €	91	1828620000	171,00 €	89
1771810000	59,15 TL	15	1790650000	256,00 €	35	1813130000	1,49 TL	36	1828630000	298,00 €	89
1771870000	13,50 TL	16	1791100000	15,10 TL	14	1813160000	1,49 TL	36	1828640000	244,00 €	89
1771930000	8,04 TL	40	1791120000	37,90 TL	14	1813190000	1,66 TL	37	1828650000	255,00 €	89
1771950000	86,10 TL	15	1791160000	4,92 TL	16	1813210000	1,66 TL	37	1828660000	208,00 €	89
1771960000	54,50 TL	15	1794040000	45,10 TL	108	1813240000	1,68 TL	37	1828670000	150,00 €	89
1773220000	4,98 TL	40	1794040000	45,10 TL	109	1813260000	1,68 TL	37	1828680000	130,00 €	89
1773230000	4,98 TL	40	1794040000	45,10 TL	110	1814660000	11,40 TL	10	1828690000	146,00 €	89
1773880000	171,55 TL	47	1794050000	45,10 TL	108	1814670000	11,40 TL	10	1828700000	113,00 €	89
1774470000	1.782,00 TL	59	1794050000	45,10 TL	109	1814680000	11,40 TL	10	1828710000	119,00 €	89
1774480000	8.915,00 TL	59	1794050000	45,10 TL	110	1814690000	109,85 TL	15	1828720000	88,50 €	89
1775480000	6,48 TL	14	1794070000	185,30 TL	108	1814700000	149,05 TL	15	1831130000	32,70 TL	15
1775490000	6,48 TL	14	1794070000	185,30 TL	109	1815070000	12,65 TL	26	1831280000	37,20 TL	15
1776030000	4,38 TL	16	1794070000	185,30 TL	110	1815080000	23,40 TL	26	1833100000	52,70 TL	11
1776040000	4,38 TL	16	1794080000	185,30 TL	108	1815090000	17,95 TL	26	1833100000	52,70 TL	15
1776120000	4,56 TL	16	1794080000	185,30 TL	109	1815100000	30,85 TL	26	1833600000	66,20 TL	11
1776130000	9,06 TL	16	1794080000	185,30 TL	110	1815110000	21,25 TL	26	1833610000	75,10 TL	11
1776140000	12,20 TL	16	1798460000	55,20 TL	5	1815120000	32,70 TL	26	1833640000	106,55 TL	11
1776150000	15,35 TL	16	1798470000	0,575 TL	39	1815130000	17,95 TL	26	1833660000	65,50 TL	7
1776200000	39,20 TL	16	1798480000	0,575 TL	39	1815140000	30,85 TL	26	1834070000	91,90 TL	8
1779080001	1,66 TL	37	1798490000	0,401 TL	39	1815150000	30,85 TL	26	1834080000	120,05 TL	8
1779080004	1,66 TL	37	1798510000	0,401 TL	39	1815160000	46,90 TL	26	1836970000	28,00 €	90
1781540001	12,40 €	91	1798520000	0,462 TL	39	1815180000	146,40 TL	26	1839850000	10,85 TL	6
1781550001	11,25 €	91	1798530000	0,462 TL	39	1815190000	15,35 TL	27	1839850000	10,85 TL	12
1782300000	43,75 TL	14	1798540000	0,337 TL	39	1815200000	27,65 TL	27	1846030000	485,00 TL	5
1782340000	7,74 TL	16	1798560000	0,337 TL	39	1815210000	36,55 TL	27	1846040000	320,50 TL	5
1782710000	6,30 TL	40	1798580000	0,439 TL	39	1815220000	48,80 TL	27	1848330000	53,35 TL	26
1782960000	0,90 €	38	1798600000	0,439 TL	39	1815280000	108,55 TL	27	1848340000	25,45 TL	27
1782970000	0,75 €	38	1798620000	0,314 TL	39	1815430000	14,35 TL	26	1848350000	30,85 TL	26
1782980000	0,90 €	38	1798640000	0,314 TL	39	1815440000	25,10 TL	26	1849670000	192,00 €	89
1782990000	7,80 TL	40				1815450000	36,55 TL	26	1849680000	111,00 €	89
1783000000	7,80 TL	40				1815500000	46,90 TL	26	1849690000	180,00 €	89
1783410000	23,05 €	91				1815510000	48,25 TL	26	1849700000	151,00 €	89
1783420000	23,05 €	91				1815520000	52,70 TL	26	1852360000	5,46 TL	38
1783430000	23,05 €	91				1815530000	60,95 TL	26	1852390000	5,46 TL	38
1783550000	13,45 TL	6				1815540000	68,70 TL	26	1852410000	5,46 TL	38
1783560000	59,80 TL	3				1815550000	77,15 TL	26	1852440000	5,46 TL	38
1783590000	57,10 TL	3				1815560000	108,55 TL	26	1852460000	5,46 TL	38
1783600000	82,85 TL	3				1815570000	111,10 TL	26	1852490000	5,46 TL	38
1783790000	49,00 TL	2				1815580000	111,80 TL	26	1854090000	1,22 TL	36
1783820000	46,90 TL	3				1815590000	113,05 TL	26	1854490000	0,612 TL	35
1783950000	88,60 TL	3				1815600000	118,80 TL	26	1854960000	18,90 TL	26
1783980000	88,60 TL	3				1815610000	127,20 TL	26	1854970000	32,70 TL	26
1784030001	12,95 €	91				1815620000	135,55 TL	26	1854990000	43,00 TL	27
1784040001	11,40 €	91				1816030000	4,38 TL	27	1855000000	57,10 TL	27
1784050001	14,00 €	91				1816050000	4,38 TL	27	1855010000	74,45 TL	27
1784060001	14,40 €	91				1816070000	5,76 TL	27	1855070000	190,75 TL	27
1784120000	38,60 TL	3				1816090000	5,76 TL	27	1855310000	1,85 €	91
1784130000	56,00 TL	3				1816240000	0,950 TL	36	1855610000	36,00 TL	3
1784150000	9,44 TL	6				1816250000	0,950 TL	36	1855620000	41,00 TL	3
1784160000	10,00 TL	6				1816260000	0,950 TL	36	1856650000	3.732,00 TL	42
1784180000	42,35 TL	2				1816290000	1,20 TL	36	1856740000	0,626 TL	35
1784210000	13,45 TL	6				1820550000	293,45 TL	5	1857440000	2,82 TL	41
1784570000	250,00 €	89				1820560000	293,45 TL	5	1860120000	5,46 TL	38
1784580000	203,00 €	89				1820840000	168,25 TL	5	1860150000	5,46 TL	38
1784590000	214,00 €	89				1820850000	168,25 TL	5	1864730000	34,95 €	90
1784600000	150,00 €	89				1820930000	86,10 TL	15	1864740000	36,00 €	90
1784610000	209,00 €	89				1822210000	509,00 TL	2	1865510000	29,50 TL	26
1784620000	173,00 €	89				1824810000	4,86 TL	50	1866690000	2,27 TL	41
1784630000	229,00 €	89				1824820000	7,20 TL	50	1866730000	658,00 TL	54
1784640000	128,00 €	89				1826040000	4,86 TL	50	1874760000	0,690 TL	39
1784670000	162,00 €	89				1826050000	86,10 TL	15	1874770000	0,889 TL	39
1784680000	146,00 €	89				1826060000	7,20 TL	50	1874780000	1,15 TL	39
1784690000	160,00 €	89				1826880000	30,00 €	91	1874790000	2,40 TL	39
1784700000	153,00 €	89				1826890000	127,20 TL	8	1874850000	0,590 TL	39
1784740000	24,00 €	90				1826900000	176,75 TL	8	1876370000	1,50 TL	38
1784750000	24,00 €	90				1826910000	233,10 TL	8	1876390000	1,50 TL	38
1784780000	26,00 €	90				1828450000	1,06 TL	35	1876570000	3,36 TL	40

Ürün Sıralı Listesi

Ürün Kodu	Birim Fiyat	Sayfa No	Ürün Kodu	Birim Fiyat	Sayfa No	Ürün Kodu	Birim Fiyat	Sayfa No	Ürün Kodu	Birim Fiyat	Sayfa No
2469370000	15,05 TL	20	2490530000	9,36 TL	22	2503910000	28,50 TL	29	2556380000	160,15 TL	110
2469400000	33,80 TL	21	2490540000	9,36 TL	22	2506090000	152,90 TL	28	2556400000	33,00 TL	107
2469410000	53,35 TL	21	2490590000	72,80 TL	21	2506340000	194,05 TL	28	2556410000	165,00 TL	108
2471430000	15,05 TL	20	2491270000	37,15 €	124	2506350000	206,95 TL	28	2556420000	160,15 TL	108
2471450000	33,80 TL	21	2491280000	37,15 €	124	2506360000	199,90 TL	28	2556440000	33,00 TL	107
2476450000	430,00 €	80	2491290000	38,50 €	124	2506370000	244,60 TL	28	2556450000	165,00 TL	107
2482160000	8,88 TL	24	2494000000	29,05 TL	20	2506380000	341,05 TL	28	2556460000	160,15 TL	108
2482170000	8,88 TL	24	2494010000	56,20 TL	21	2517450000	125,00 €	117	2561430000	5.200,00 TL	62
2482180000	11,00 TL	24	2494020000	84,70 TL	21	2518250000	295,90 TL	31	2566380000	428,00 €	80
2482190000	11,00 TL	24	2494100000	29,05 TL	20	2518330000	549,00 TL	31	2576620000	480,00 TL	64
2482200000	12,35 TL	24	2495040000	3,05 €	125	2518340000	1.054,00 TL	31	2578530000	25,45 €	123
2482210000	12,35 TL	24	2495070000	3,05 €	125	2518540000	490,40 TL	32	2578550000	27,00 €	123
2482220000	31,15 TL	25	2495080000	3,50 €	125	2518570000	593,00 TL	32	2578560000	30,05 €	123
2482230000	38,70 TL	25	2495090000	3,05 €	125	2519470000	965,00 TL	32	2580000000	29.167,00 €	64
2482240000	41,45 TL	25	2495100000	6,00 €	125	2519480000	960,00 TL	32	2580180000	32,00 €	123
2482250000	11,00 TL	25	2495380000	3,00 €	125	2519490000	982,00 TL	32	2580190000	48,00 €	123
2482260000	11,00 TL	25	2496190000	42,00 €	108	2521730000	742,00 TL	32	2580210000	50,00 €	123
2482270000	11,00 TL	25				2522720000	25,90 TL	28	2580220000	48,00 €	123
2482280000	11,00 TL	25				2522830000	41,15 TL	28	2580230000	60,00 €	123
2482290000	11,00 TL	25				2522840000	32,40 TL	29	2580240000	60,00 €	123
2482300000	11,00 TL	25				2522860000	58,30 TL	29	2580250000	75,00 €	123
2482310000	11,00 TL	25				2522870000	28,50 TL	29	2580260000	75,00 €	123
2482320000	11,00 TL	25				2524850000	172,45 TL	133	2580270000	75,00 €	123
2482330000	11,00 TL	25				2526810000	29,95 €	76	2587360000	84,00 €	123
2482340000	11,00 TL	25				2527880000	173,00 €	76	2587360000	84,00 €	124
2482350000	18,50 TL	25				2527890000	180,00 €	76	2588460000	34,75 TL	73
2482360000	25,90 TL	25				2527900000	191,00 €	76	2588580000	44,15 TL	73
2482370000	33,40 TL	25				2527910000	222,00 €	76	2588630000	94,00 TL	73
2482380000	40,85 TL	25				2527920000	197,00 €	76	2588720000	116,25 TL	73
2482390000	48,35 TL	25				2527930000	209,00 €	76	2588770000	123,05 TL	73
2482400000	55,90 TL	25				2527940000	219,00 €	76	2588790000	134,30 TL	73
2482410000	63,25 TL	25				2527950000	249,00 €	76	2588850000	186,50 TL	73
2482420000	70,75 TL	25				2530180000	90,00 €	132	2589110000	24,00 TL	73
2482430000	78,25 TL	25				2530550000	72,00 €	132	2589130000	27,00 TL	73
2482440000	45,00 TL	25				2530580000	164,00 €	132	2589150000	39,00 TL	73
2482450000	37,50 TL	25				2530590000	176,00 €	132	2589180000	56,00 TL	73
2482460000	29,60 TL	25				2530610000	151,00 €	132	2589210000	36,00 TL	73
2482510000	5,46 TL	25				2530620000	162,00 €	132	2589230000	47,00 TL	73
2482520000	5,46 TL	25				2530640000	98,00 €	132	2589240000	64,00 TL	73
2483990000	169,30 TL	133				2530650000	108,00 €	132	2589260000	80,00 TL	73
2485840000	17,20 TL	24				2534130000	4.758,00 €	120	2589280000	45,00 TL	73
2485850000	17,20 TL	24				2534160000	4.758,00 €	120	2589300000	56,00 TL	73
2485860000	39,60 TL	25				2535770000	131,00 €	76	2589310000	70,00 TL	73
2485870000	61,15 TL	25				2535810000	222,00 €	76	2589330000	106,00 TL	73
2485920000	38,65 TL	24				2535830000	286,00 €	76	2589370000	68,00 TL	73
2485930000	38,65 TL	24				2535850000	353,00 €	76	2589380000	88,00 TL	73
2485980000	4,92 TL	25				2535870000	420,00 €	76	2589400000	115,00 TL	73
2486070000	75,00 €	122				2535890000	509,00 €	76	2589420000	85,00 TL	73
2486080000	130,00 €	122				2535910000	553,00 €	76	2589440000	106,00 TL	73
2486090000	135,00 €	123				2535930000	2.000,00 €	96	2589450000	192,00 TL	73
2486100000	180,00 €	123				2535940000	1.900,00 €	96	2589470000	128,45 TL	73
2486110000	205,00 €	123				2535960000	2.093,00 €	96	2589490000	137,00 TL	73
2486640000	8,28 TL	22				2536600000	850,00 €	96	2589990000	90,00 TL	73
2486660000	6,66 TL	22				2536650000	857,00 €	96	2590000000	73,90 TL	73
2488560000	103,00 TL	52				2536680000	1.100,00 €	96	2590020000	64,50 TL	73
2488560000	103,00 TL	53				2536690000	1.096,00 €	96	2590050000	55,10 TL	73
2488580000	149,00 TL	52				2539970000	23,50 TL	20	2590080000	28,20 TL	73
2488580000	149,00 TL	54				2539990000	49,40 TL	21	2590110000	16,15 TL	73
2488590000	155,05 TL	53				2540040000	23,50 TL	20	2591020000	32,00 €	128
2488590000	155,05 TL	54				2548180000	380,00 TL	64	2591030000	46,00 €	128
2488590000	155,05 TL	55				2551510000	49,40 TL	20	2591040000	72,00 €	128
2488600000	165,40 TL	53				2551520000	77,60 TL	21	2591050000	80,00 €	128
2488600000	165,40 TL	54				2552090000	49,40 TL	20	2591060000	72,00 €	128
2489830000	404,00 €	81				2555660000	515,00 €	85	2591070000	84,00 €	128
2490360000	22,90 TL	20				2555780000	680,00 €	85	2591080000	119,00 €	128
2490370000	22,90 TL	20				2555790000	974,00 €	85	2591090000	150,00 €	128
2490380000	8,88 TL	22				2555940000	265,00 €	81	2591140000	122,00 €	128
2490390000	8,88 TL	22				2556360000	33,00 TL	107	2591150000	126,00 €	128
2490440000	49,95 TL	21				2556360000	33,00 TL	110	2591160000	110,00 €	128
2490510000	36,05 TL	20				2556370000	165,00 TL	107	2591170000	130,00 €	128
2490520000	36,05 TL	20				2556370000	165,00 TL	110	2599430000	2.200,00 €	35

Ürün Kodu	Birim Fiyat	Sayfa No
2600000000		
2602200000	6.800,00 TL	62
2602750000	1,07 TL	78
2602760000	2,38 TL	78
2602770000	2,76 TL	78
2602780000	5,94 TL	78
2602790000	7,38 TL	78
2602800000	13,10 TL	78
2614380000	390,00 €	80
2618000000	93,50 TL	107
2618010000	169,55 TL	107
2618050000	169,55 TL	107
2618150000	212,25 TL	107
2618200000	212,25 TL	107
2618220000	122,65 TL	107
2624980000	70,00 €	124
2624990000	74,00 €	124
2625000000	105,00 €	124
2638920000	825,00 €	80
2639560000	444,55 TL	108
2639730000	Sorunuz	108
2656670000	68,00 €	124
2657800000	16,00 TL	32
2657820000	20,55 TL	32
2657840000	26,60 TL	32
2657860000	32,00 TL	32
2657960000	16,00 TL	32
2657980000	20,55 TL	32
2658000000	26,60 TL	32
2658020000	32,00 TL	32
2658120000	39,25 TL	32
2658140000	61,00 TL	32
2658240000	39,25 TL	32
2658260000	61,00 TL	32
2658360000	41,70 TL	32
2658380000	53,45 TL	32
2658400000	71,90 TL	32
2658420000	86,40 TL	32
2658440000	100,90 TL	32
2658540000	45,00 TL	32
2658560000	53,45 TL	32
2658580000	71,90 TL	32
2658600000	86,40 TL	32
2658620000	110,00 TL	32
2658720000	86,10 TL	32
2658740000	110,25 TL	32
2658860000	86,10 TL	32
2658880000	110,25 TL	32
2658970000	2,75 TL	32
2658990000	3,29 TL	32
2659030000	4,39 TL	32
2659040000	17,95 TL	32
2659050000	27,45 TL	32
2659060000	27,45 TL	32
2659310000	0,600 TL	78
2659320000	0,884 TL	78
2659330000	1,30 TL	78
2659340000	1,63 TL	78
2659350000	2,94 TL	78
2659360000	4,44 TL	78
2659370000	0,600 TL	78
2659380000	0,751 TL	78
2659390000	1,28 TL	78
2659400000	1,37 TL	78
2659410000	2,94 TL	78
2659420000	4,44 TL	78
2659430000	0,600 TL	78
2659440000	0,884 TL	78
2659450000	1,27 TL	78
2659460000	1,37 TL	78
2659470000	2,94 TL	78

Ürün Kodu	Birim Fiyat	Sayfa No
2659480000	4,44 TL	78
2659490000	0,540 TL	78
2659500000	0,884 TL	78
2659510000	1,27 TL	78
2659520000	1,37 TL	78
2659530000	2,94 TL	78
2659540000	4,44 TL	78
2659600000	4,00 TL	32
2661310000	580,00 €	80
2665800000	2.205,00 €	84
2665810000	2.058,00 €	84
2665820000	5.775,00 €	84
2665830000	2.730,00 €	84
2676340000	1.785,00 €	84
2676350000	2.268,00 €	84
2676370000	2.394,00 €	84
2676380000	2.541,00 €	84
2676390000	3.150,00 €	84
2676400000	3.843,00 €	84
2676410000	4.788,00 €	84
2676420000	5.460,00 €	84
2676430000	2.520,00 €	84
2676450000	3.045,00 €	84
2676460000	3.360,00 €	84
2676470000	3.255,00 €	84
2676480000	3.570,00 €	84
2676490000	3.500,00 €	84
2676500000	3.780,00 €	84
2676510000	4.032,00 €	85
2676520000	5.817,00 €	85
2676530000	4.305,00 €	85
2676540000	6.069,00 €	85
2676550000	5.124,00 €	85
2676560000	6.930,00 €	85
2676570000	5.439,00 €	85
2676580000	7.350,00 €	85
2676660000	2.121,00 €	85
2676670000	2.247,00 €	85
2676680000	2.415,00 €	85
2676690000	3.150,00 €	85
2676700000	3.654,00 €	85
2676710000	25,20 €	84
2676720000	49,35 €	84
2683640000	24.407,00 TL	64
2683720000	20.136,00 TL	64
2697250000	585,00 TL	108
2697270000	698,00 TL	108
2697280000	531,00 TL	108
2697290000	531,00 TL	108
3400000000		
3489000000	157,90 TL	10
4000000000		
4058570000	26,75 TL	100
4058600000	34,40 TL	100
4058610000	55,00 TL	100
4058630000	53,20 TL	100
4100000000		
4144870000	301,90 TL	50
4157440000	240,25 TL	50
4300000000		
4323210000	3,35 €	133
4323220000	3,50 €	133
4323230000	3,35 €	133
4323240000	3,35 €	133
4329610000	3,35 €	133

Ürün Kodu	Birim Fiyat	Sayfa No
7500000000		
7508001876	162,00 €	133
7508001907	206,00 €	133
7508001928	180,00 €	133
7508002014	206,00 €	133
7512000541	Sorunuz	132
7512000542	Sorunuz	132
7512000543	Sorunuz	132
7700000000		
7730000011	27,55 TL	73
7730000012	56,45 TL	73
7730000013	31,90 TL	73
7730000014	65,10 TL	73
7730000015	8,20 TL	74
7730000016	9,00 TL	74
7730000017	11,00 TL	74
7730000018	12,00 TL	74
7730000019	14,00 TL	74
7730000020	15,00 TL	74
7730000021	24,00 TL	74
7730000022	26,00 TL	74
7730000023	30,00 TL	74
7730000025	52,00 TL	74
7730000026	10,00 TL	74
7730000027	10,00 TL	74
7730000028	11,00 TL	74
7730000029	12,00 TL	74
7730000031	13,20 TL	74
7730000032	14,00 TL	74
7730000033	19,00 TL	74
7730000035	24,00 TL	74
7730000037	47,00 TL	74
7730000409	17,00 TL	74
7730000458	64,00 TL	73
7730000459	8,00 TL	74
7730000460	36,00 TL	74
7730000461	57,00 TL	74
7730000481	35,00 TL	74
7730000489	21,00 TL	74
7730000490	70,15 TL	73
7760052061	3,45 €	126
7760052061	3,45 €	126
7760054115	260,00 €	114
7760054117	275,00 €	114
7760054119	200,00 €	114
7760054120	158,00 €	114
7760054121	200,00 €	114
7760054122	210,00 €	114
7760054123	150,00 €	114
7760054124	230,00 €	114
7760054164	200,00 €	115
7760054165	220,00 €	115
7760054175	127,00 €	117
7760054176	144,00 €	117
7760054177	138,00 €	117
7760054178	121,00 €	117
7760054179	83,00 €	117
7760054180	99,00 €	117
7760054181	92,00 €	117
7760054182	94,00 €	117
7760054244	154,00 €	117
7760054245	176,00 €	117
7760054246	120,00 €	117
7760054247	144,00 €	117
7760054248	83,00 €	117
7760054299	132,00 €	117
7760054300	135,00 €	117
7760054305	230,00 €	115
7760054306	255,00 €	115

Ürün Kodu	Birim Fiyat	Sayfa No
7760054307	125,00 €	117
7760054308	145,00 €	117
7760056014	24,00 TL	105
7760056014	24,00 TL	106
7760056015	15,40 TL	105
7760056016	15,40 TL	105
7760056017	15,05 TL	105
7760056018	15,05 TL	105
7760056045	24,00 TL	105
7760056050	39,60 TL	104
7760056051	39,60 TL	104
7760056052	40,40 TL	104
7760056053	44,65 TL	104
7760056054	57,75 TL	104
7760056055	40,40 TL	104
7760056056	40,40 TL	104
7760056057	40,40 TL	104
7760056058	44,65 TL	104
7760056059	42,35 TL	104
7760056060	42,35 TL	104
7760056061	43,20 TL	104
7760056062	48,00 TL	104
7760056063	58,25 TL	104
7760056064	45,10 TL	104
7760056065	44,10 TL	104
7760056066	44,10 TL	104
7760056067	46,75 TL	104
7760056078	42,35 TL	104
7760056079	42,35 TL	104
7760056080	42,55 TL	104
7760056081	46,15 TL	104
7760056082	58,25 TL	104
7760056083	43,50 TL	104
7760056084	42,55 TL	104
7760056085	43,50 TL	104
7760056086	47,40 TL	104
7760056087	45,10 TL	104
7760056088	45,10 TL	104
7760056089	45,70 TL	104
7760056090	49,35 TL	104
7760056091	63,90 TL	104
7760056092	47,30 TL	104
7760056093	46,25 TL	104
7760056094	48,55 TL	104
7760056095	55,05 TL	104
7760056096	45,70 TL	104
7760056097	46,75 TL	104
7760056098	49,25 TL	105
7760056099	52,00 TL	105
7760056100	66,00 TL	105
7760056101	49,60 TL	105
7760056102	49,60 TL	105
7760056103	50,90 TL	105
7760056104	52,30 TL	105
7760056106	24,00 TL	105
7760056107	30,25 TL	105
7760056108	1,22 TL	105
7760056108	1,22 TL	106
7760056169	7,88 TL	105
7760056169	7,88 TL	106
7760056225	77,70 TL	106
7760056226	97,95 TL	106
7760056227	113,70 TL	106
7760056234	7,50 TL	106
7760056235	7,50 TL	106
7760056296	33,20 TL	102
7760056297	33,95 TL	102
7760056298	37,20 TL	102
7760056299	40,75 TL	102
7760056300	44,85 TL	102
7760056301		

Ürün Sıralı Listesi

Ürün Kodu	Birim Fiyat	Sayfa No
7760056302	44,85 TL	102
7760056303	38,70 TL	102
7760056304	39,60 TL	102
7760056305	42,90 TL	102
7760056306	45,70 TL	102
7760056307	50,00 TL	103
7760056308	48,90 TL	103
7760056309	50,00 TL	103
7760056310	38,70 TL	103
7760056311	39,60 TL	103
7760056312	41,95 TL	103
7760056313	45,70 TL	103
7760056314	43,85 TL	103
7760056315	44,85 TL	103
7760056316	46,90 TL	103
7760056317	51,30 TL	103
7760056318	55,65 TL	103
7760056319	54,40 TL	103
7760056320	57,15 TL	103
7760056321	36,35 TL	103
7760056322	37,20 TL	103
7760056323	38,70 TL	103
7760056324	42,55 TL	103
7760056325	46,75 TL	103
7760056326	45,70 TL	103
7760056327	48,00 TL	103
7760056328	43,85 TL	103
7760056329	44,85 TL	103
7760056330	46,90 TL	103
7760056331	51,30 TL	103
7760056332	54,40 TL	103
7760056333	54,40 TL	103
7760056334	57,15 TL	103
7760056335	43,85 TL	103
7760056336	44,85 TL	103
7760056337	46,90 TL	103
7760056338	51,30 TL	103
7760056339	48,90 TL	103
7760056340	50,00 TL	103
7760056341	51,90 TL	103
7760056342	56,45 TL	103
7760056343	60,75 TL	103
7760056344	62,35 TL	103
7760056345	62,35 TL	103
7760056350	28,20 TL	104
7760056351	30,25 TL	104
7760056352	3,23 TL	104
7760056362	77,85 TL	105
7760056363	88,20 TL	105
7760056364	47,05 TL	104
7760056365	50,80 TL	104
7791400879	350,00 €	132

Ürün Kodu	Birim Fiyat	Sayfa No
7921570000	70,00 TL	15
7921600000	75,70 TL	11
7921600000	75,70 TL	15
7940006040	0,130 TL	77
7940006047	0,130 TL	77
7940006050	0,146 TL	77
7940006051	0,146 TL	77
7940006056	0,660 TL	77
7940006057	0,660 TL	77
7940006064	0,625 TL	77
7940006065	0,625 TL	77
7940006068	0,900 TL	77
7940006069	0,900 TL	77
7940006070	1,60 TL	77
7940006071	1,60 TL	77
7940006072	1,81 TL	77
7940006073	1,81 TL	77
7940006074	5,40 TL	77
7940006075	5,40 TL	77
7940007742	225,80 TL	102
7940018455	15,80 TL	105
7940018457	15,40 TL	105
7940045760	387,00 €	114

8000000000		
8074700000	76,90 TL	101

8200000000		
8227350000	92,05 €	117
8237710000	391,85 TL	108
8260280000	92,05 €	117

8300000000		
8365980000	170,90 TL	108
8389030000	17,50 TL	108
8390590000	298,60 TL	108

8400000000		
8411190000	150,00 €	117
8420880000	373,00 TL	108
8425720000	116,00 €	117
8448920000	325,00 TL	130
8448940000	325,00 TL	130
8448960000	318,60 TL	130
8448970000	319,30 TL	130
8449000000	351,20 TL	130
8449030000	360,55 TL	130
8449040000	426,85 TL	130
8449050000	372,40 TL	130
8449140000	195,95 TL	130
8449150000	199,00 TL	130
8449160000	191,00 TL	130
8472880000	293,80 TL	130
8473000000	116,00 €	117
8473010000	116,00 €	117
8473020000	116,00 €	117
8483680000	120,00 €	117

8600000000		
8604420000	130,00 €	117
8604430000	116,00 €	117
8630740000	6,90 TL	6
8630740000	6,90 TL	16
8630740000	6,90 TL	22
8647680000	64,35 €	108
8647700000	95,00 €	108
8647720000	80,00 €	108
8647740000	130,00 €	108
8659840000	22,95 €	108

Ürün Kodu	Birim Fiyat	Sayfa No
8689760000	63,85 TL	101
8689770000	137,90 TL	101
8689800000	118,35 TL	101
8689810000	91,45 TL	101
8689820000	66,00 TL	101
8689830000	114,50 TL	101
8689860000	60,00 TL	101
8689950000	141,55 TL	101
8689980000	140,00 TL	101
8689990000	155,30 TL	101
8690000000	67,00 TL	101
8690010000	186,85 TL	101
8690030000	63,85 TL	101
8690040000	63,85 TL	101
8690110000	71,20 TL	101
8690120000	95,00 TL	101
8690150000	158,95 TL	101
8690160000	82,00 TL	101
8690200000	63,85 TL	101
8690570000	186,85 TL	102
8690610000	125,75 TL	102
8690630000	154,05 TL	102
8690650000	138,00 TL	102
8690830000	40,00 TL	100
8690880000	42,00 TL	101
8690890000	41,00 TL	101
8690900000	47,00 TL	101
8690950000	24,40 TL	100
8690950000	24,40 TL	101
8691010000	29,00 TL	100
8691010000	29,00 TL	101
8691030000	29,00 TL	100
8691030000	29,00 TL	101
8691040000	49,75 TL	101
8691060000	41,40 TL	100
8691060000	41,40 TL	101
8691090000	4,26 TL	100
8691110000	4,50 TL	101
8693260000	26,00 TL	100
8693320000	59,15 TL	100
8693500000	29,80 TL	100
8693890000	55,55 TL	100

8700000000		
8704240000	428,80 TL	130
8731720000	34,75 TL	15
8734580000	14,00 €	74
8771420000	76,35 €	118
8771430000	72,45 €	118
8778490000	15,00 €	118
8794120000	103,00 €	118
8799030000	148,25 TL	102

8800000000		
8805550000	105,00 €	118
8808420000	4.500,00 TL	98
8823280000	355,55 TL	130
8852350000	86,95 €	118
8857030000	100,00 €	118
8869350000	49,80 TL	102
8869390000	45,00 TL	101
8869430000	103,10 TL	101
8869440000	4,45 TL	101
8869490000	40,00 TL	100
8869500000	58,45 TL	100
8869510000	3,84 TL	100
8869590000	31,90 TL	100
8869590000	31,90 TL	101
8869630000	49,75 TL	100
8869630000	49,75 TL	101

Ürün Kodu	Birim Fiyat	Sayfa No
8869650000	52,45 TL	100
8869650000	52,45 TL	101
8869810000	40,65 TL	100
8869840000	50,00 TL	100
8869850000	55,55 TL	100
8869860000	55,90 TL	100
8869890000	34,20 TL	100
8869920000	38,75 TL	100
8869930000	74,80 TL	100
8869940000	76,25 TL	100
8870100000	55,05 TL	100
8870130000	67,10 TL	100
8870140000	76,60 TL	100
8870150000	115,50 TL	100
8870180000	51,35 TL	100
8870210000	51,35 TL	100
8870220000	97,40 TL	100
8870370000	91,75 TL	100
8870840000	16,40 TL	100
8870850000	17,40 TL	101
8871000000	123,35 TL	102
8871010000	140,35 TL	102
8871020000	186,85 TL	102
8871030000	127,00 TL	102
8871040000	166,70 TL	102
8871050000	158,40 TL	102
8876220000	94,35 TL	101
8897090000	153,15 TL	102
8897100000	161,10 TL	102

8900000000		
8920940000	204,00 TL	102
8920950000	270,00 TL	102
8920960000	250,45 TL	102
8920970000	231,85 TL	102
8920980000	267,50 TL	102
8920990000	238,90 TL	102
8921010000	155,20 TL	102
8921020000	245,90 TL	102
8921030000	216,00 TL	102
8921040000	241,00 TL	102
8921050000	228,50 TL	102
8921060000	212,80 TL	102
8924200000	193,00 €	129
8924210000	99,60 €	129
8924220000	193,00 €	129
8924230000	99,60 €	129
8924260000	64,50 €	130
8924270000	58,90 €	129
8924280000	37,50 €	130
8924290000	37,50 €	129
8924320000	193,00 €	129
8924330000	99,60 €	129
8924340000	193,00 €	129
8924350000	99,60 €	129
8924360000	193,00 €	129
8924370000	99,60 €	129
8924380000	193,00 €	129
8924400000	172,00 €	129
8924420000	91,00 €	129
8924440000	172,00 €	129
8924450000	91,00 €	129
8924470000	172,00 €	129
8924480000	91,00 €	129
8924490000	172,00 €	129
8924500000	91,00 €	129
8924520000	91,00 €	129
8924530000	91,00 €	129
8924700000	58,90 €	130
8924710000	54,50 €	129
8924720000	32,00 €	130

Ürün Sıralı Listesi

Ürün Kodu	Birim Fiyat	Sayfa No
9205430000	19.918,00 TL	59
9205440000	19.918,00 TL	59
9205560000	1.154,00 TL	60

9400000000

9423580000	3.390,00 TL	61
9425830000	1.363,00 TL	61
9427300000	1.829,00 TL	61
9427370000	4.159,00 TL	61
9427460000	4.327,00 TL	61
9427520000	3.145,00 TL	61
9456050000	0,55 €	91
9456180000	98,65 €	88
9456190000	80,80 €	88
9456200000	87,75 €	88
9456210000	141,00 €	88
9456230000	187,00 €	88
9456320000	108,00 €	88
9456330000	103,00 €	88
9456340000	140,00 €	88
9456350000	165,00 €	88
9456370000	235,00 €	88
9456460000	144,00 €	88
9456470000	117,00 €	88
9456480000	124,00 €	88
9456490000	161,00 €	88
9456510000	199,00 €	88
9456600000	146,00 €	88
9456610000	144,00 €	88
9456620000	154,00 €	88
9456630000	187,00 €	88
9456650000	238,00 €	88
9456740000	149,00 €	88
9456750000	120,00 €	88
9456760000	121,00 €	88
9456770000	177,00 €	88
9456790000	238,00 €	88
9456880000	157,00 €	88
9456890000	140,00 €	88
9456900000	190,00 €	88
9456910000	258,00 €	88
9456930000	258,00 €	88

9500000000

9512190000	227,40 TL	5
9512200000	430,30 TL	5
9512240000	84,80 TL	8
9512250000	123,35 TL	8
9512420000	227,40 TL	5
9531290000	155,50 TL	8
9532440000	75,10 TL	4
9532470000	17,45 TL	6
9535170000	17,50 €	66
9535210000	20,00 €	66
9535230000	19,00 €	66
9535290000	23,80 €	66
9535310000	24,85 €	66
9535330000	25,95 €	66
9535370000	30,05 €	66
9535430000	41,10 €	66
9535470000	48,65 €	66
9535690000	53,55 €	66
9535710000	69,00 €	66
9535730000	93,00 €	67
9535750000	95,15 €	67
9535770000	113,00 €	67
9535810000	215,00 €	67
9540000000	6,06 TL	6
9540000000	6,06 TL	16

Ürün Kodu	Birim Fiyat	Sayfa No
9900000000		
9918130000	324,40 TL	60
9918140000	317,90 TL	60
9918150000	324,40 TL	60
9918700000	33.869,00 TL	58
9918840000	2.578,00 TL	61
9918860000	1.059,00 TL	61
9918870000	2.431,00 TL	61
9918880000	959,00 TL	61
9918950000	345,50 TL	61

So00000000

Sorunuz	Sorunuz	55
Sorunuz	Sorunuz	55
Sorunuz	Sorunuz	55
Sorunuz	Sorunuz	55
Sorunuz	Sorunuz	55
Sorunuz	Sorunuz	132
Sorunuz	Sorunuz	132
Sorunuz	Sorunuz	132

Ürün Kodu	Birim Fiyat	Sayfa No
-----------	-------------	----------

Ürün Kodu	Birim Fiyat	Sayfa No
-----------	-------------	----------



Yetkili Bayilerimiz

ADANA

ÖZTEKNİK ENERJİ
Tel : (322) 359 30 60
Fax : (322) 394 47 44
E - mail : info@ozteknikenerji.com

ADAPAZARI

AKIŞIK
Tel : (264) 291 43 05
Fax : (264) 291 45 42
E - mail: akisikelektrik@gmail.com

ELPİM ELEKTRİK

Tel : (264) 276 00 83
Fax : (264) 275 19 00
E - mail: elpim@elpim.com.tr

ANKARA

ALPAN
Tel : (312) 354 96 63
Fax : (312) 354 96 66
E - mail: alpan@alpanelektrik.com

ARDA

Tel : (312) 385 80 37
Fax : (312) 385 80 58
E-mail: arda@ardaelektrik.com

ANTALYA

GÜNEŞTOPU ELEKTRİK
Tel: (242) 344 6434
Fax: (242) 221 6607
Mail: info@gunestopuelektrik.com

BURSA

HARMES ELEKTRİK
Tel : (224) 443 04 52
Fax : (224) 443 04 53
E-mail: harmes@harmeselektrik.com

FRM OTOMASYON

Tel: (224) 441 05 11
Fax: (224) 441 05 15
E-mail: satis@frmotomasyon.com.tr

DENİZLİ

MATEK OTOMASYON
Tel : (258) 263 03 13
Fax : (258) 263 14 08
E - mail: info@matekotomasyon.com

ESKİŞEHİR

KIRAÇ ELEKTRİK
Tel : (222) 236 15 00
Fax : (222) 236 15 01
E-mail: kirac@kiracelektrik.com.tr

GAZİANTEP

GEYLANİ ENERJİ
Tel : (342) 215 30 60
Fax : (342) 215 30 64
E-mail: geylani@geylanienerji.com

İSTANBUL ANADOLU

BOTEK OTOMASYON (ÜMRANİYE)
Tel: (216) 527 75 31
Fax: (216) 321 58 43
Mail:botek@botekotomasyon.com

DOLFIN ELEKTRİK (TUZLA)

Tel: (216) 446 05 11
Fax: (216) 446 13 37
Mail: info@dolfinelektrik.com.tr

ELSİS ELEKTRİK (ÜMRANİYE)

Tel : (216) 466 98 03
Fax : (216) 466 98 59
E-mail: info@elsiselektrik.com.tr

SARNİKON (ATAŞEHİR)

Tel : (212) 593 71 71
Fax : (212) 593 71 72
E-mail: info@sarnikon.com

İSTANBUL - AVRUPA

ERGİN ELEKTRİK (PERPA)
Tel : (212) 220 13 13
Fax : (212) 222 88 20
E-mail: danisma@ergin.com.tr

SOYLU OTOMASYON (İKİTELLİ)

Tel : (212) 671 33 56
Fax : (212) 671 33 60
E-mail: info@soyluotomasyon.com

ÜÇ - EL ELEKTRİK (KARAKÖY)

Tel : (212) 297 03 71
Fax : (212) 237 63 43
E-mail: ucel@uceelektrik.com.tr

VEGA ELEKTRİK (PERPA)

Tel : (212) 320 84 20
Fax : (212) 320 94 20
E-mail: info@vegaelektrik.com.tr

İZMİR

BOLEM ELEKTRİK
Tel : (232) 469 95 95
Fax : (232) 469 78 69
E-mail: bolem@bolemelk.com

TEM

Tel : (232) 441 61 11
Fax : (232) 457 44 75
E-mail: temelektrik@temelektrik.com

KOCAELİ

GENESİS OTOMASYON
Tel : (262) 323 26 06
Fax : (262) 321 58 43
E-mail: teklif@genesisotomasyon.com

KONYA

ŞALT OTOMASYON
Tel : (332) 345 31 81
Fax : (332) 345 31 84
E-mail: info@saltotomasyon.com

SAMSUN

GALİP MÜHENDİSLİK
Tel : (362) 435 27 13
Fax : (362) 431 50 05
E-mail: galip@galip.com.tr

TEKİRDAĞ

BOTEM BOBİNAJ (ÇORLU)
Tel : (282) 652 33 56
Fax : (282) 653 21 68
E-mail: info@botem.com.tr

Otomasyon Partnerlerimiz

ADANA

BOYSAN MÜHENDİSLİK (ADANA)
Tel : (322) 453 49 63
Fax : (322) 453 98 10
E-Mail : boysan@boysan.com.tr

ESKİŞEHİR

ANOT (ESKİŞEHİR)
Tel : (222) 236 16 16
Fax : (222) 236 16 11
E-mail: bilgi@anot.com.tr

GAZİANTEP

BİRMAG (GAZİANTEP)
Tel : (342) 215 05 04
Fax : (342) 215 05 99
E-mail: birmag@birmag.com

KONYA

SİMKON (KONYA)
Tel : (332) 346 16 00
Fax : (332) 346 16 02
E-mail: info@simkonmuhendislik.com

İSTANBUL ANADOLU

İSTANBUL SENSÖRLER (ÜMRANİYE)
Tel: (216) 520 31 50
Fax: (216) 520 31 84
E-mail: bilgi@isac.com.tr

SGS AUTOMATION & DRIVES (GEBZE)

Tel : (262) 641 63 43
Fax : (262) 641 72 62
E-mail: sgs@sgsteknik.com

YÖN OTOMASYON (ÜMRANİYE)

Tel : (216) 415 72 24
Fax : (216) 415 72 84
E-mail: info@yonotomasyon.com

İZMİR

Pİ OTOMASYON
Tel : (232) 435 42 77
Fax : (232) 435 42 71
E-mail: info@piotomasyon.com.tr

Satış Koşulları

Fiyat Listesi için geçerli olan Genel Satış Koşullarımıza; www.weidmuller.com.tr adresindeki "Fiyat Listesi" bölümünden ulaşabilirsiniz.

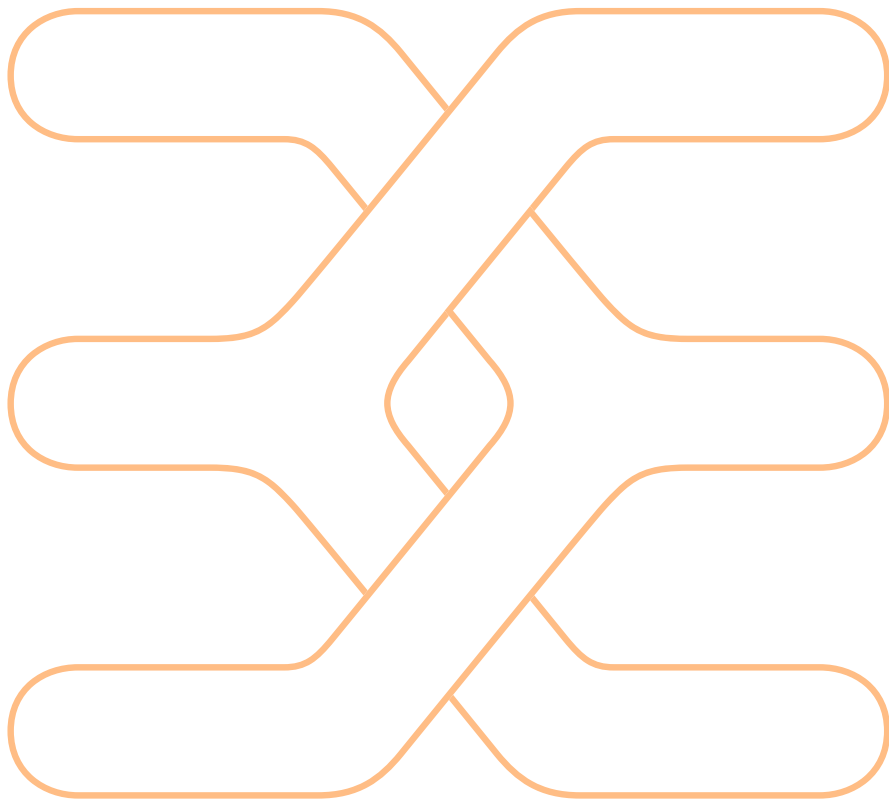

Weidmüller, elektriksel veri aktarımı ve güç bağlantı teknolojisi komponentleri alanında uzun yıllara dayanan tecrübesiyle en köklü üreticilerden biridir. Ürün portföyümüz ray ve baskılı devre klemensleri, sanayi tipi fiş-soketler, röle ve optokuplörler, sinyal dönüştürücüleri, güç kaynakları, aşırı gerilim koruma modülleri ve daha birçok ürün grubunu içermekte ve tüm endüstriyel kullanım alanlarına uygunluk göstermektedir. Elektrik tesisat ve markalama ürünleri, I/O modülleri ve el aletleri seçenekleri ile ürün yelpazemiz tamamlanmaktadır. Weidmüller, endüstriyel bağlantı teknolojisi alanındaki inovasyon odaklı yenilikçi çalışmalarıyla, global standartların oluşturulmasında öncü rol oynamaktadır.

Dünya Çapındaki Adreslerimiz

Let's connect.

Satış Organizasyonu	●
Yurtdışı Temsilciliği	●
Distribütör	●

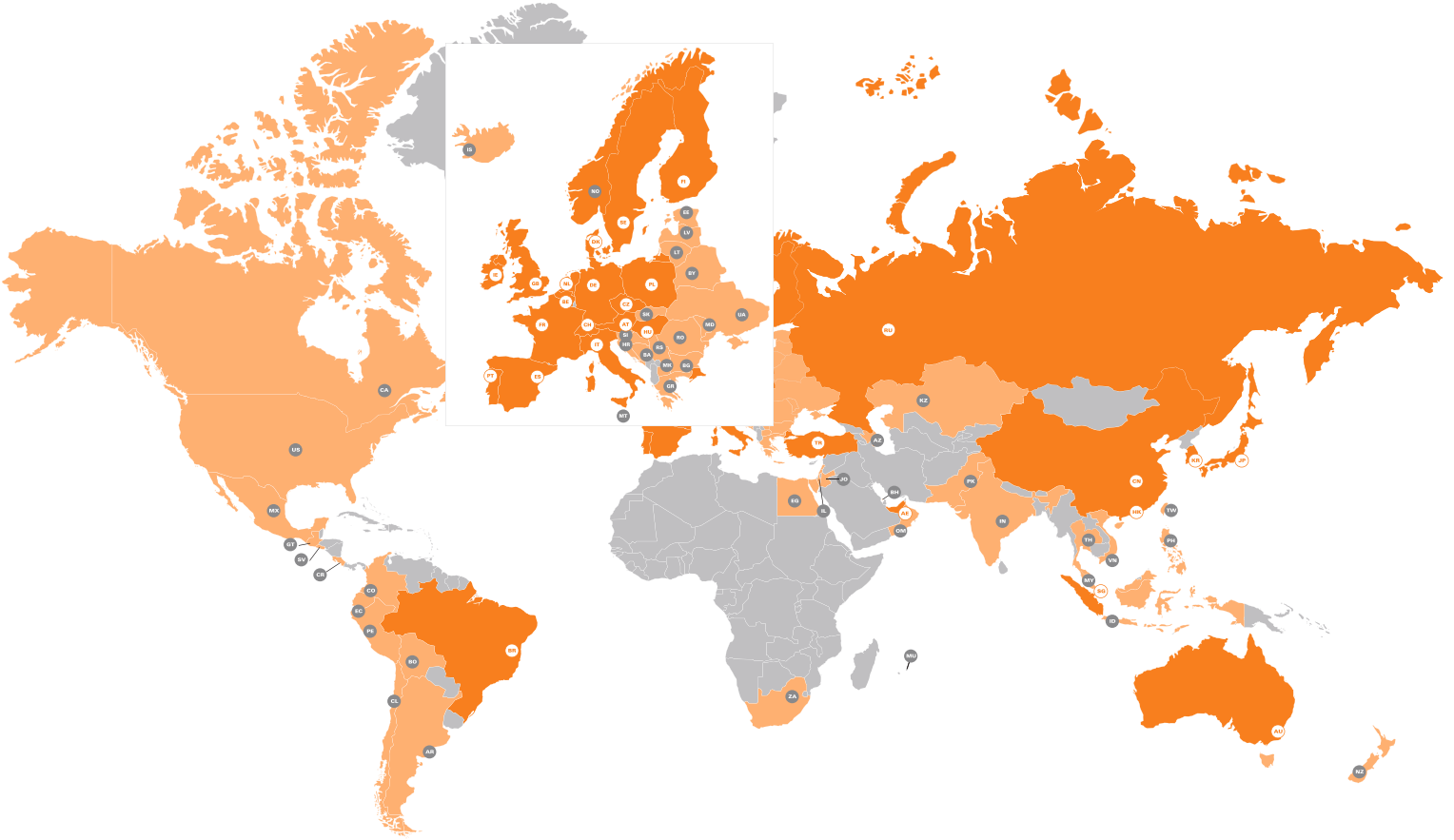

Weidmüller Elektronik Ticaret Ltd. Şti. | Çubuklu Mah. Orhan Veli Kanık Cad. 9, 34805 Beykoz - İstanbul, Turkey

Tel. 0216 537 10 70 | Faks 0216 537 10 77 | E-mail: info@weidmueller.com.tr | www.weidmueller.com.tr

■ **Adana / Gaziantep Bölge**
Tel. 0533 764 48 43

■ **Ankara Bölge**
Tel. 0533 348 49 62

■ **Bursa Bölge**
Tel. 0530 978 98 46

■ **İzmir Bölge**
Tel. 0530 236 37 50

■ **Kocaeli Bölge**
Tel. 0533 344 61 89

■ **Konya Bölge**
Tel. 0530 978 98 47

■ **Samsun Bölge**
Tel. 0534 890 11 28